

# 400MHz Multiplexing Amplifier

## ISL59420

The ISL59420 is a 420MHz bandwidth 2:1 multiplexing amplifier designed primarily for video switching. This Mux-amp has user-settable gain and also feature a high speed three-state function to enable the output of multiple devices to be wired together. All logic inputs have pull-downs to ground and may be left floating. The  $\overline{\text{ENABLE}}$  pin, when pulled high, sets the ISL59420 to the low current power-down mode for power sensitive applications - consuming just 5mW.

TABLE 1. CHANNEL SELECT LOGIC TABLE

S0	$\overline{\text{ENABLE}}$	HIZ	OUTPUT
0	0	0	IN0
1	0	0	IN1
X	1	X	Power Down
X	0	1	High Z

## Related Literature

- See [AN1187](#), "ISL59420/21EVAL1 Evaluation Board User's Guide"

## Features

- 420MHz (-3dB) Bandwidth ( $A_V = 1$ ,  $V_{OUT} = 400mV_{P-P}$ )
- 165MHz (-3dB) Bandwidth ( $A_V = 2$ ,  $V_{OUT} = 2V_{P-P}$ )
- Slew Rate ( $A_V = 1$ ,  $R_L = 500\Omega$ ,  $V_{OUT} = 4V$ ).....966V/ $\mu$ s
- Slew Rate ( $A_V = 2$ ,  $R_L = 500\Omega$ ,  $V_{OUT} = 5V$ ).....1462V/ $\mu$ s
- Selectable Gain
- High Speed Three-State Output (HIZ)
- Low Current Power-Down ..... 5mW
- Pb-Free (RoHS Compliant)

## Applications

- HDTV/DTV Analog Inputs
- Video Projectors
- Computer Monitors
- Set-Top Boxes
- Security Video
- Broadcast Video Equipment

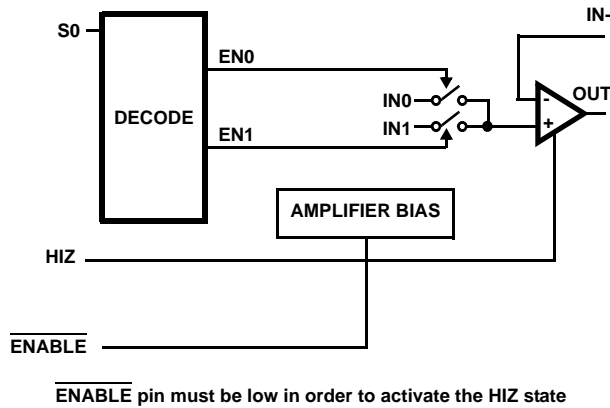
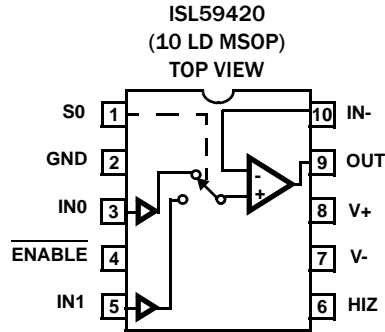

FIGURE 1. FUNCTIONAL DIAGRAM

# ISL59420

## Pin Configuration



## Pin Descriptions

PIN NUMBER	PIN NAME	EQUIVALENT CIRCUIT	DESCRIPTION
1	S0	Circuit 2	Channel selection pin LSB (binary logic code)
2	GND	Circuit 4	Ground pin
3	IN0	Circuit 1	Input for channel 0
4	ENABLE	Circuit 2	Device enable (active low); there are internal pull-down resistors, so the device will be active with no connection; "HI" puts device into power-down mode.
5	IN1	Circuit 1	Input for channel 1
6	HIZ	Circuit 2	Output disable (active high); there are internal pull-down resistors, so the device will be active with no connection; "HI" puts the output in high impedance state.
7	V-	Circuit 4	Negative power supply
8	V+	Circuit 4	Positive power supply
9	OUT	Circuit 3	Output
10	IN-	Circuit 1	Inverting input of output amplifier

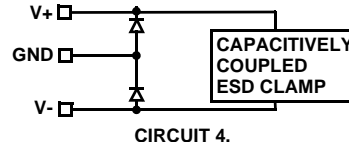
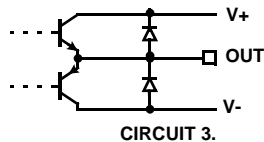
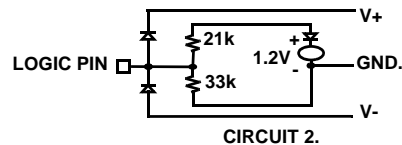
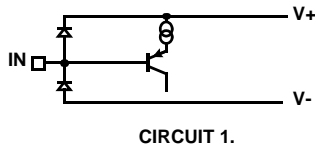

## Ordering Information

PART NUMBER (Notes 2, 3)	PART MARKING	PACKAGE (Pb-free)	TAPE & REEL	PKG. DWG. #
ISL59420IUZ	BBPAA	10 Ld MSOP	-	M10.118A
ISL59420IUZ-T7 (Note 1)	BBPAA	10 Ld MSOP	7"	M10.118A
ISL59420IUZ-T13 (Note 1)	BBPAA	10 Ld MSOP	13"	M10.118A

### NOTES:

- Please refer to [TB347](#) for details on reel specifications.
- These Intersil Pb-free plastic packaged products employ special Pb-free material sets, molding compounds/die attach materials, and 100% matte tin plate plus anneal (e3 termination finish, which is RoHS compliant and compatible with both SnPb and Pb-free soldering operations). Intersil Pb-free products are MSL classified at Pb-free peak reflow temperatures that meet or exceed the Pb-free requirements of IPC/JEDEC J STD-020.
- For Moisture Sensitivity Level (MSL), please see device information page for [ISL59420](#). For more information on MSL please see tech brief [TB363](#).

# ISL59420

## Absolute Maximum Ratings (T<sub>A</sub> = 25 °C)

Supply Voltage (V+ to V-)	11V
Input Voltage	V- -0.5V, V+ +0.5V
Supply Turn-on Slew Rate	1V/μs
I <sub>N</sub> Input Current (Note 4)	5mA
Digital & Analog Input Current (Note 4)	50mA
Output Current (Continuous)	50mA
ESD Rating	
Human Body Model (Per MIL-STD-883 Method 3015.7)	2.5kV
Machine Model	300V

## Thermal Information

Storage Temperature Range	-65 °C to +150 °C
Ambient Operating Temperature	-40 °C to +85 °C
Operating Junction Temperature	-40 °C to +125 °C
Power Dissipation	See Curves
θ <sub>JA</sub>	See Figures 22 and 23 on page 8
Pb-Free Reflow Profile	see link below
	<a href="http://www.intersil.com/pbfree/Pb-FreeReflow.asp">http://www.intersil.com/pbfree/Pb-FreeReflow.asp</a>

**CAUTION:** Do not operate at or near the maximum ratings listed for extended periods of time. Exposure to such conditions may adversely impact product reliability and result in failures not covered by warranty.

### NOTE:

- If an input signal is applied before the supplies are powered up, the input current must be limited to these maximum values.

**IMPORTANT NOTE:** All parameters having Min/Max specifications are guaranteed. Typical values are for information purposes only. Unless otherwise noted, all tests are at the specified temperature and are pulsed tests, therefore: T<sub>J</sub> = T<sub>C</sub> = T<sub>A</sub>

## Electrical Specifications V+ = +5V, V- = -5V, GND = 0V, T<sub>A</sub> = 25 °C, R<sub>L</sub> = 500Ω to GND unless otherwise specified.

PARAMETER	DESCRIPTION	CONDITIONS	MIN (NOTE 5)	TYP	MAX (NOTE 5)	UNIT
<b>GENERAL</b>						
±I <sub>S</sub> Enabled	Supply Current	No load, V <sub>IN</sub> = 0V, $\overline{\text{ENABLE}}$ Low	9.5	11	15	mA
I <sub>S</sub> Disabled	Disabled Supply Current I+	No load, V <sub>IN</sub> = 0V, $\overline{\text{ENABLE}}$ High	0.5	1	1.5	mA
	Disabled Supply Current I-	No load, V <sub>IN</sub> = 0V, $\overline{\text{ENABLE}}$ High		3	10	μA
V <sub>OUT</sub>	Positive Output Swing	V <sub>IN</sub> = 2V, R <sub>L</sub> = 500Ω, A <sub>V</sub> = 2	3.5	3.9		V
	Negative Output Swing	V <sub>IN</sub> = -2V, R <sub>L</sub> = 500Ω, A <sub>V</sub> = 2		-3	-2.8	V
I <sub>OUT</sub>	Output Current	R <sub>L</sub> = 10Ω to GND	80	130		mA
V <sub>OS</sub>	Output Offset Voltage		-12	4	+12	mV
I <sub>b+</sub>	Input Bias Current	V <sub>IN</sub> = 0V	-4	-2.5	-1.5	μA
I <sub>b-</sub>	Feedback Bias Current		-15	7	15	μA
R <sub>out</sub>	Output Resistance	HIZ = logic high, (DC), A <sub>V</sub> = 1		1.4		MΩ
		HIZ = logic low, (DC), A <sub>V</sub> = 1		0.2		Ω
R <sub>IN</sub>	Input Resistance	V <sub>IN</sub> = 3.5V		10		MΩ
A <sub>CL</sub> or A <sub>V</sub>	Voltage Gain	R <sub>F</sub> = R <sub>G</sub> = 600Ω, V <sub>OUT</sub> = ±3V	1.990	2.005	2.020	V/V
I <sub>TRI</sub>	Output Current in Three-state	V <sub>OUT</sub> = 0V	-20	6	20	μA
<b>LOGIC</b>						
V <sub>H</sub>	Input High Voltage (Logic Inputs)		2			V
V <sub>L</sub>	Input Low Voltage (Logic Inputs)				0.8	V
I <sub>IH</sub>	Input High Current (Logic Inputs)		55	90	135	μA
I <sub>IL</sub>	Input Low Current (Logic Inputs)		-10	0	10	μA
<b>AC GENERAL</b>						
-3dB BW	-3dB Bandwidth	A <sub>V</sub> = 1, R <sub>F</sub> = 200Ω, V <sub>OUT</sub> = 400MV <sub>P-P</sub> , C <sub>L</sub> = 5.5pF, C <sub>G</sub> = 0.6pF		420		MHz
		A <sub>V</sub> = 2, R <sub>F</sub> = R <sub>G</sub> = 453Ω, V <sub>OUT</sub> = 2V <sub>P-P</sub> , C <sub>L</sub> = 5.5pF, C <sub>G</sub> = 0.6pF		165		MHz

# ISL59420

## Electrical Specifications $V_+ = +5V, V_- = -5V, GND = 0V, T_A = 25^\circ C, R_L = 500\Omega$ to GND unless otherwise specified. (Continued)

PARAMETER	DESCRIPTION	CONDITIONS	MIN (NOTE 5)	TYP	MAX (NOTE 5)	UNIT
0.1dB BW	0.1dB Bandwidth	$A_V = 1, R_F = 200\Omega, V_{OUT} = 100mV_{P-P}, C_L = 5.5pF, C_G = 0.6pF$		25		MHz
		$A_V = 2, R_F = R_G = 453\Omega, V_{OUT} = 2V_{P-P}, C_L = 5.5pF, C_G = 0.6pF$		60		MHz
dG	Differential Gain Error	NTC-7, $R_L = 150, C_L = 5.5pF, A_V = 1$		0.01		%
		NTC-7, $R_L = 150, C_L = 5.5pF, A_V = 2$		0.05		%
dP	Differential Phase Error	NTC-7, $R_L = 150, C_L = 5.5pF, A_V = 1$		0.02		°
		NTC-7, $R_L = 150, C_L = 5.5pF, A_V = 2$		0.02		°
+SR	Slew Rate	25% to 75%, $A_V = 1, V_{OUT} = 4V, R_L = 500\Omega, C_L = 5.5pF$		966		V/ $\mu$ s
		25% to 75%, $A_V = 2, V_{OUT} = 5V, R_L = 500\Omega, C_L = 5.5pF$		1462		V/ $\mu$ s
-SR	Slew Rate	25% to 75%, $A_V = 1, V_{OUT} = 4V, R_L = 500\Omega, C_L = 5.5pF$		788		V/ $\mu$ s
		25% to 75%, $A_V = 2, V_{OUT} = 5V, R_L = 500\Omega, C_L = 5.5pF$		1171		V/ $\mu$ s
PSRR	Power Supply Rejection Ratio	DC, PSRR $V_+$ and $V_-$ combined	-60	-68		dB
ISO	Channel Isolation	$f = 10MHz$ , Ch-Ch X-Talk and Off Isolation, $C_L = 5.5pF$		75		dB
<b>SWITCHING CHARACTERISTICS</b>						
$V_{GLITCH}$	Channel-to-Channel Switching Glitch	$V_{IN} = 0V, C_L = 5.5pF, A_V = 2$		36		mV $_{P-P}$
	ENABLE Switching Glitch	$V_{IN} = 0V, C_L = 5.5pF, A_V = 2$		475		mV $_{P-P}$
	HIZ Switching Glitch	$V_{IN} = 0V, C_L = 5.5pF, A_V = 2$		360		mV $_{P-P}$
$t_{SW-L-H}$	Channel Switching Time Low to High	1.2V logic threshold to 10% movement of analog output		24		ns
$t_{SW-H-L}$	Channel Switching Time High to Low	1.2V logic threshold to 10% movement of analog output		19		ns
<b>TRANSIENT RESPONSE</b>						
$t_R, t_F$	Rise & Fall Time, 10% to 90%	$A_V = 1, R_F = 200\Omega, V_{OUT} = 100mV_{P-P}, C_L = 5.5pF, C_G = 0.6pF$		0.83		ns
		$A_V = 2, R_F = R_G = 453\Omega, V_{OUT} = 2V_{P-P}, C_L = 5.5pF, C_G = 0.6pF$		1.64		ns
$t_S$	0.1% Settling Time	$A_V = 2, R_F = R_G = 453\Omega, V_{OUT} = 2V_{P-P}, C_L = 5.5pF, C_G = 0.6pF$		8.8		ns
$O_S$	Overshoot	$A_V = 1, R_F = 200\Omega, V_{OUT} = 100mV_{P-P}, C_L = 5.5pF, C_G = 0.6pF$		24		%
		$A_V = 2, R_F = R_G = 453\Omega, V_{OUT} = 2V_{P-P}, C_L = 5.5pF, C_G = 0.6pF$		10		%
$t_{PLH}$	Propagation Delay - Low to High, 10% to 10%	$A_V = 1, R_F = 200\Omega, V_{OUT} = 100mV_{P-P}, C_L = 5.5pF, C_G = 0.6pF$		0.5		ns
		$A_V = 2, R_F = R_G = 453\Omega, V_{OUT} = 2V_{P-P}, C_L = 5.5pF, C_G = 0.6pF$		1.01		ns
$t_{PHL}$	Propagation Delay- High to Low, 10% to 10%	$A_V = 1, R_F = 200\Omega, V_{OUT} = 100mV_{P-P}, C_L = 5.5pF, C_G = 0.6pF$		0.65		ns
		$A_V = 2, R_F = R_G = 453\Omega, V_{OUT} = 2V_{P-P}, C_L = 5.5pF, C_G = 0.6pF$		1.08		ns

**NOTE:**

5. Parameters with MIN and/or MAX limits are 100% tested at +25°C, unless otherwise specified. Temperature limits established by characterization and are not production tested.

**Typical Performance Curves**  $V_S = \pm 5V$ ,  $R_L = 500\Omega$  to GND,  $T_A = 25^\circ C$ , unless otherwise specified.

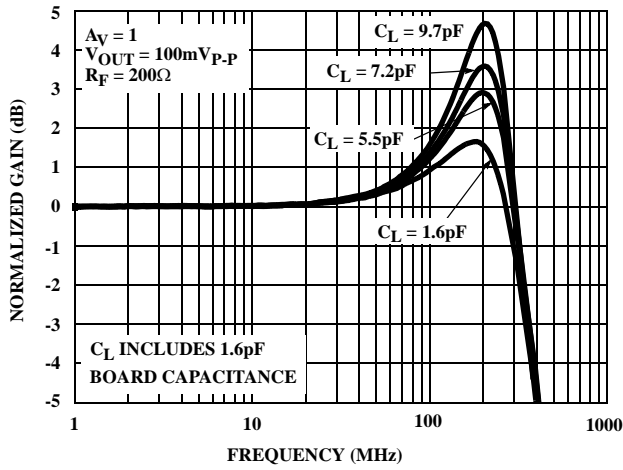

FIGURE 2. SMALL SIGNAL GAIN vs FREQUENCY vs  $C_L$

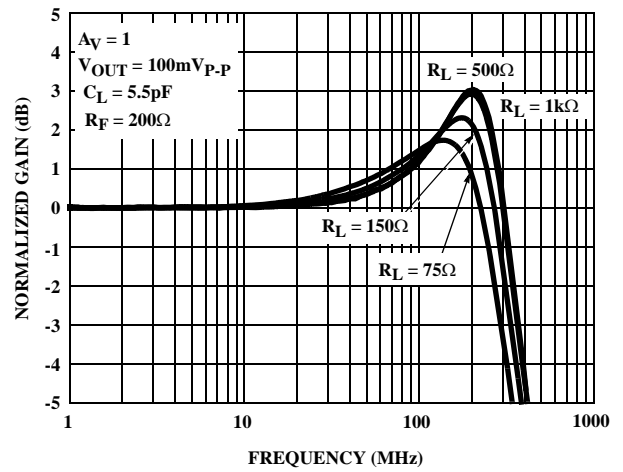

FIGURE 3. SMALL SIGNAL GAIN vs FREQUENCY vs  $R_L$

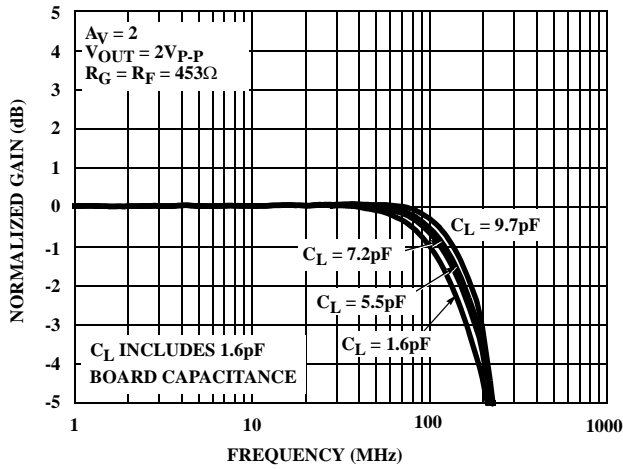

FIGURE 4. LARGE SIGNAL GAIN vs FREQUENCY vs  $C_L$

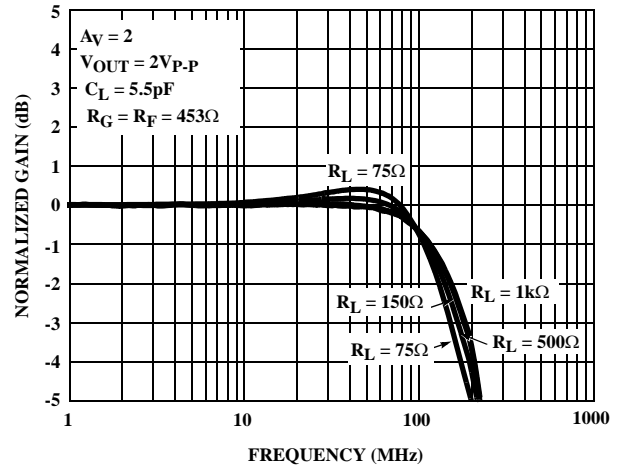

FIGURE 5. LARGE SIGNAL GAIN vs FREQUENCY vs  $R_L$

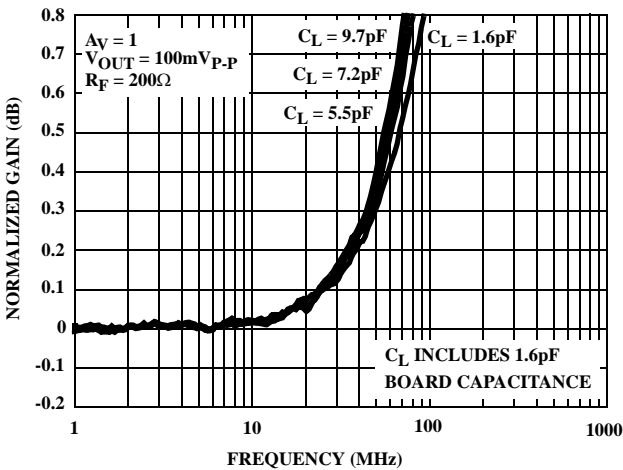

FIGURE 6. SMALL SIGNAL 0.1dB GAIN vs FREQUENCY vs  $C_L$

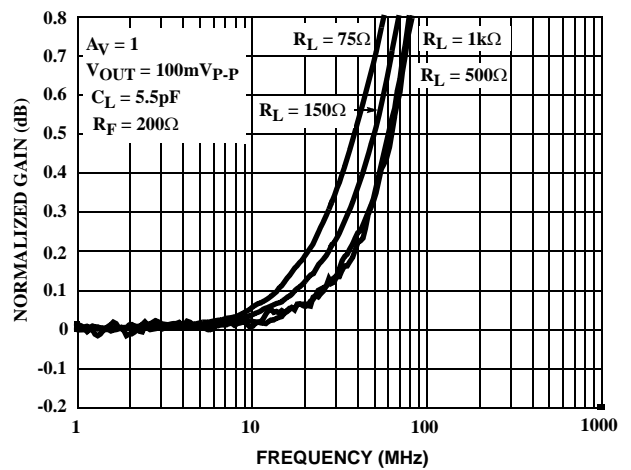

FIGURE 7. SMALL SIGNAL 0.1dB GAIN vs FREQUENCY vs  $R_L$

**Typical Performance Curves**  $V_S = \pm 5V$ ,  $R_L = 500\Omega$  to GND,  $T_A = 25^\circ C$ , unless otherwise specified. (Continued)

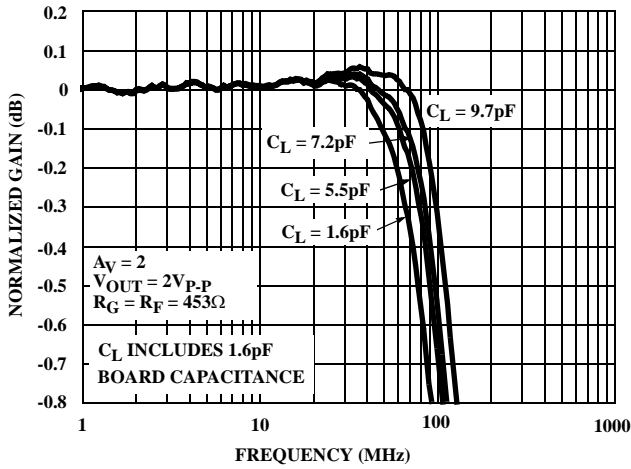

FIGURE 8. LARGE SIGNAL 0.1dB GAIN vs FREQUENCY vs  $C_L$

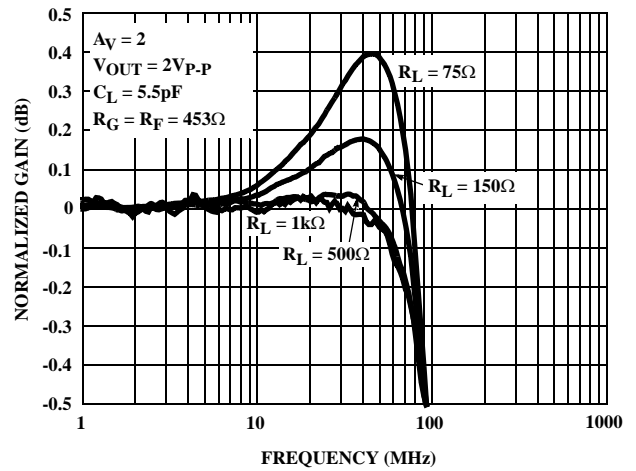

FIGURE 9. LARGE SIGNAL 0.1dB GAIN vs FREQUENCY vs  $R_L$

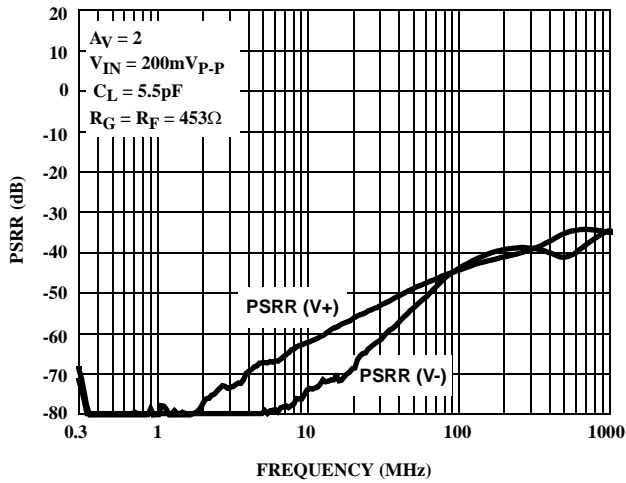

FIGURE 10. PSRR CHANNELS

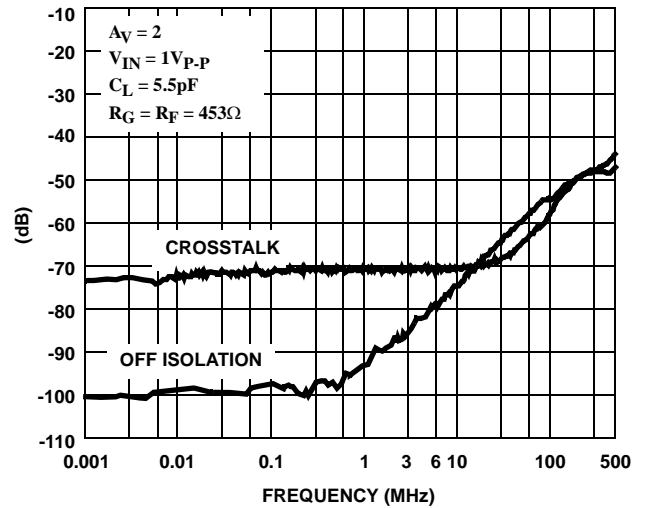

FIGURE 11. CROSSTALK AND OFF ISOLATION

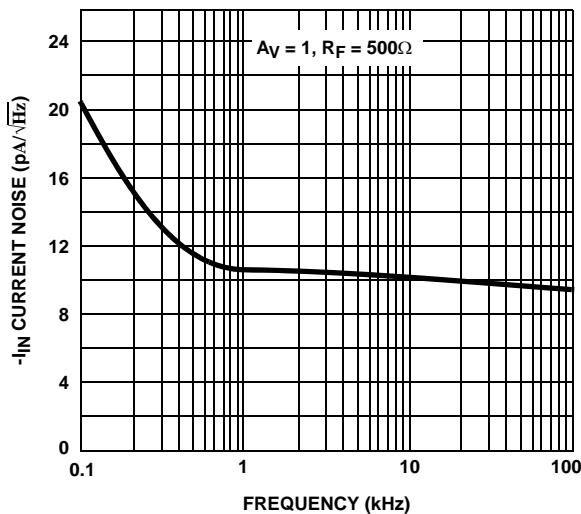

FIGURE 12. INPUT NOISE vs FREQUENCY

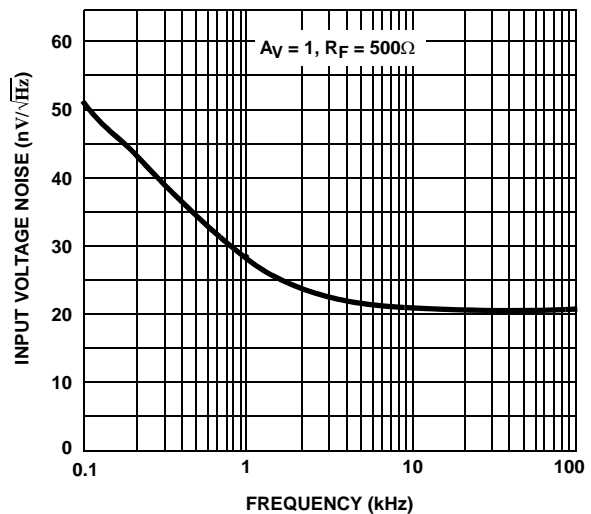

FIGURE 13. INPUT NOISE vs FREQUENCY

**Typical Performance Curves**  $V_S = \pm 5V$ ,  $R_L = 500\Omega$  to GND,  $T_A = 25^\circ C$ , unless otherwise specified. (Continued)

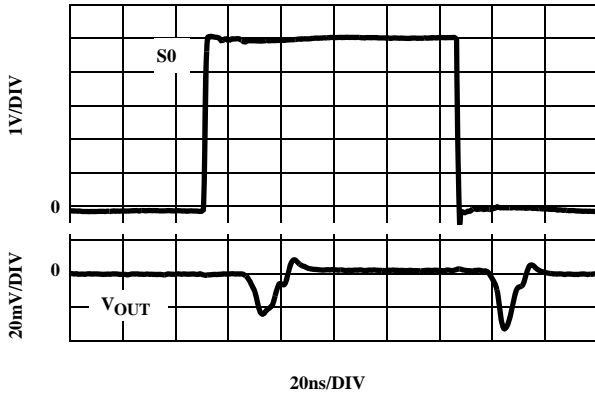

FIGURE 14. CHANNEL TO CHANNEL SWITCHING GLITCH  $V_{IN} = 0V$ ,  $A_V = 2$

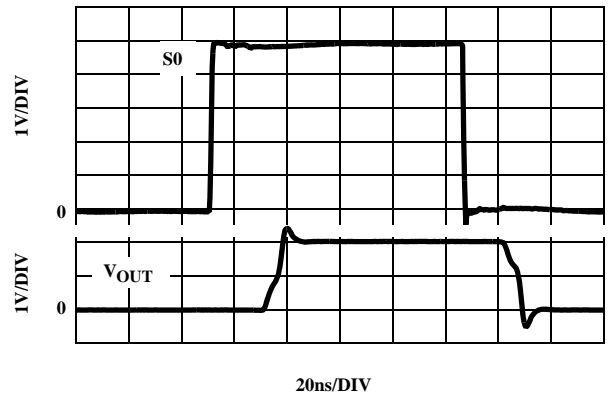

FIGURE 15. CHANNEL TO CHANNEL TRANSIENT RESPONSE  $V_{IN} = 1V$ ,  $A_V = 2$

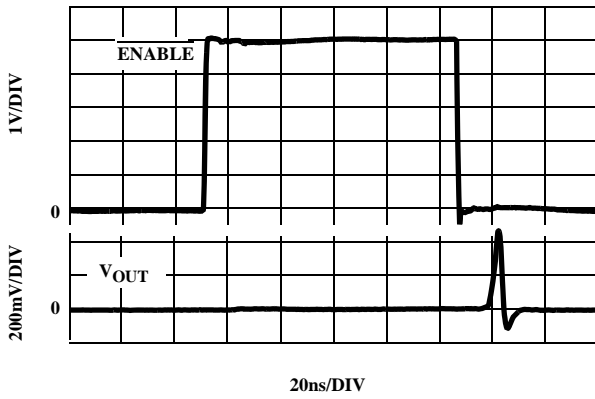

FIGURE 16.  $\overline{\text{ENABLE}}$  SWITCHING GLITCH  $V_{IN} = 0V$ ,  $A_V = 2$

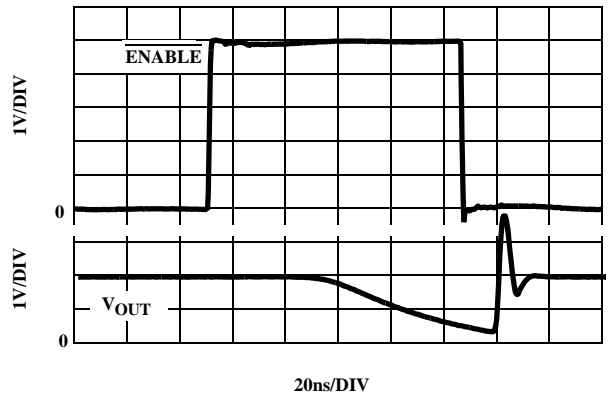

FIGURE 17.  $\overline{\text{ENABLE}}$  TRANSIENT RESPONSE  $V_{IN} = 1V$ ,  $A_V = 2$

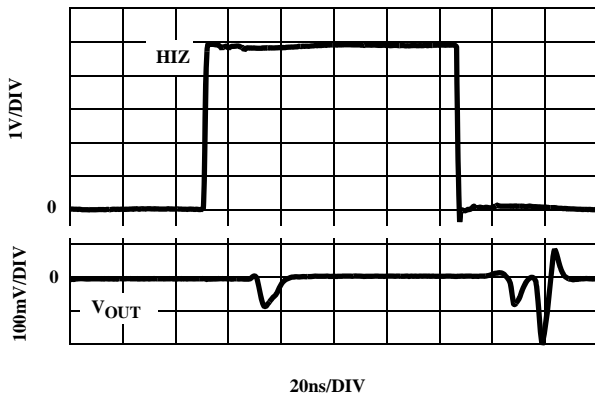

FIGURE 18. HIZ SWITCHING GLITCH  $V_{IN} = 0V$ ,  $A_V = 2$

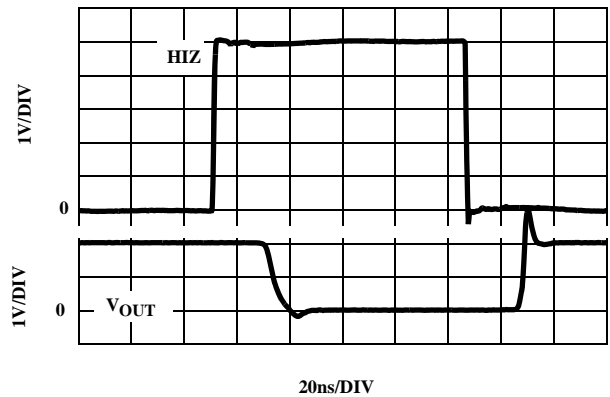

FIGURE 19. HIZ TRANSIENT RESPONSE  $V_{IN} = 1V$ ,  $A_V = 2$

## Typical Performance Curves $V_S = \pm 5V$ , $R_L = 500\Omega$ to GND, $T_A = 25^\circ C$ , unless otherwise specified. (Continued)

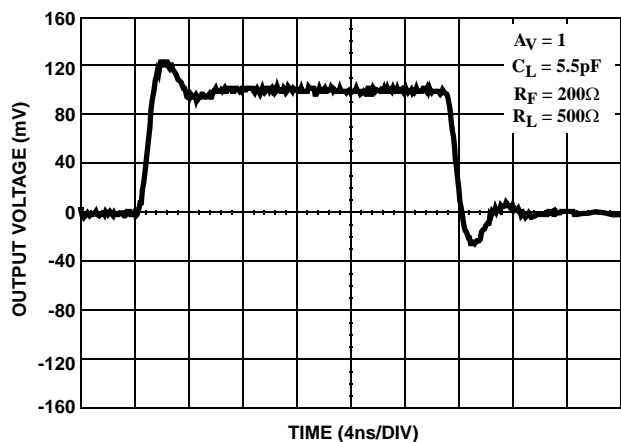

FIGURE 20. SMALL SIGNAL TRANSIENT RESPONSE

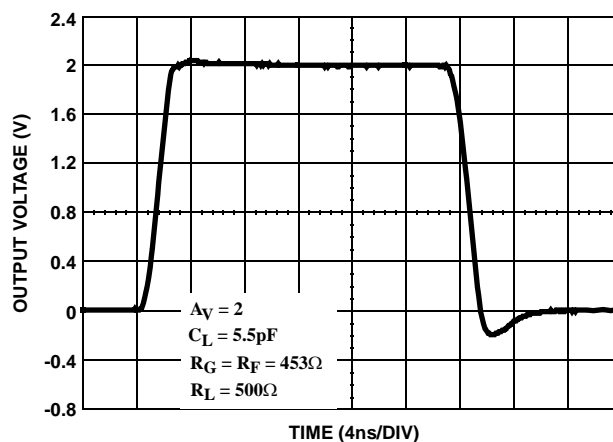

FIGURE 21. LARGE SIGNAL TRANSIENT RESPONSE

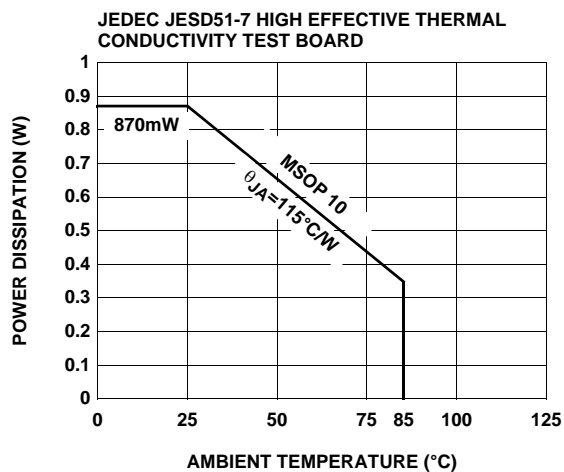

FIGURE 22. PACKAGE POWER DISSIPATION vs AMBIENT TEMPERATURE

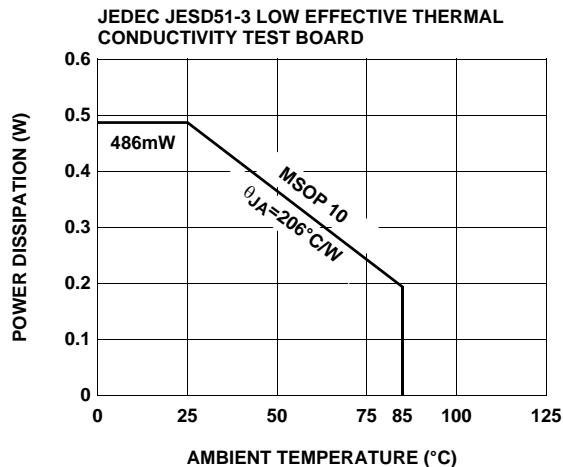

FIGURE 23. PACKAGE POWER DISSIPATION vs AMBIENT TEMPERATURE

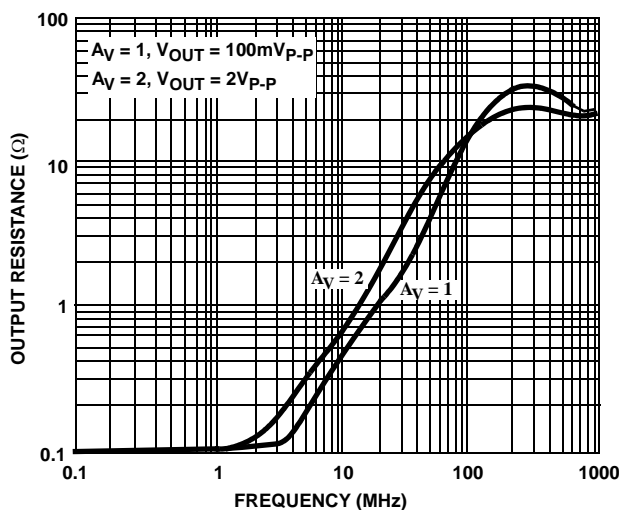

FIGURE 24.  $R_{OUT}$  vs FREQUENCY



## AC Test Circuits

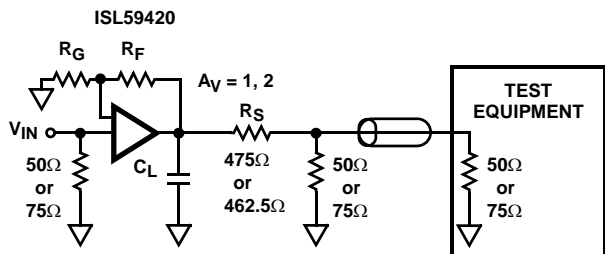

FIGURE 25A. TEST CIRCUIT FOR MEASURING WITH A 50Ω OR 75Ω INPUT TERMINATED EQUIPMENT

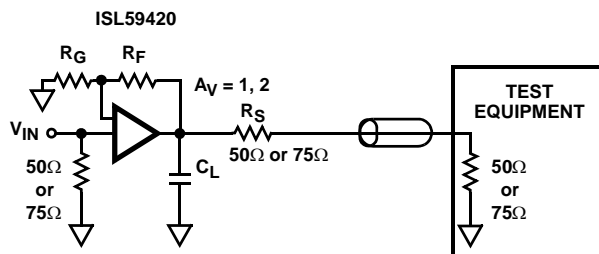

FIGURE 25B. BACKLOADED TEST CIRCUIT FOR VIDEO CABLE APPLICATION. BANDWIDTH AND LINEARITY FOR  $R_L$  LESS THAN 500Ω WILL BE DEGRADED.

NOTE: Figure 25A illustrates the optimum output load when connecting to input terminated equipment. Figure 26B illustrates backloaded test circuit for video cable applications.

## Application Circuits

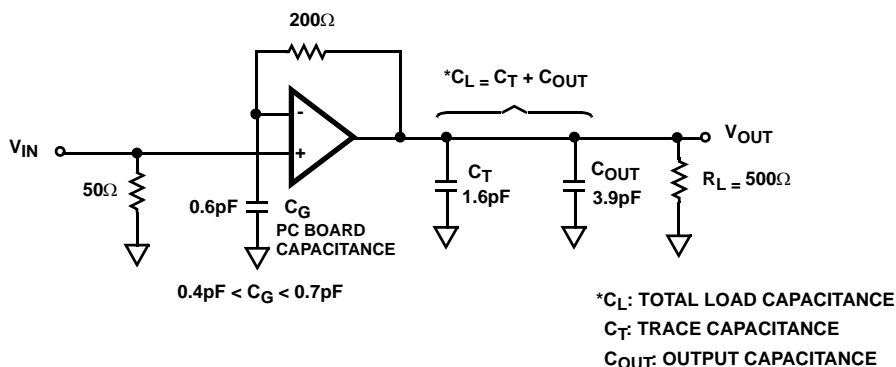

FIGURE 26A. GAIN OF 1 APPLICATION CIRCUIT

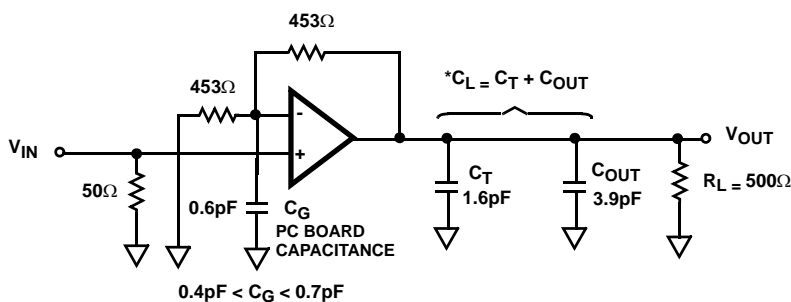

FIGURE 26B. GAIN OF 2 APPLICATION CIRCUIT

## Application Information

### General

The ISL59420 is a 2:1 mux that is ideal as a matrix element in high performance switchers and routers. The ISL59420 is optimized to drive 5pF in parallel with a 500Ω load. The capacitance can be split between the PCB capacitance and an external load capacitance. Its low input capacitance and high input resistance provide excellent 50Ω or 75Ω terminations.

### Parasitic Effects on Frequency Performance

#### Capacitance at the Inverting Input

The AC performance of current-feedback amplifiers in the non-inverting gain configuration is strongly affected by stray capacitance at the inverting input. Stray capacitance from the inverting input pin to the output ( $C_F$ ), and to ground ( $C_G$ ), increase gain peaking and bandwidth. Large values of either capacitance can cause oscillation. The ISL59420 has been optimized for a 0.4pF to 0.7pF capacitance ( $C_G$ ). Capacitance ( $C_F$ ) to the output should be minimized. To achieve optimum performance the feedback network resistor(s) must be placed as close to the device as possible. Trace lengths greater than 1/4 inch combined with resistor pad capacitance can result in inverting input to ground capacitance approaching 1pF. Inverting input and output traces should not run parallel to each other. Small size surface mount resistors (604 or smaller) are recommended.

#### Capacitance at the Output

The output amplifier is optimized for capacitance to ground ( $C_L$ ) directly on the output pin. Increased capacitance causes higher peaking with an increase in bandwidth. The optimum range for most applications is ~1.0pF to ~6pF. The optimum value can be achieved through a combination of PC board trace capacitance ( $C_T$ ) and an external capacitor ( $C_{OUT}$ ). A good method to maintain control over the output pin capacitance is to minimize the trace length ( $C_T$ ) to the next component, and include a discrete surface mount capacitor ( $C_{OUT}$ ) directly at the output pin.

#### Feedback Resistor Values

The AC performance of the output amplifier is optimized with the feedback resistor network ( $R_F$ ,  $R_G$ ) values recommended in the application circuits. The amplifier bandwidth and gain peaking are directly affected by the value(s) of the feedback resistor(s) in unity gain and gain >1 configurations. Transient response performance can be tailored simply by changing these resistor values. Generally, lower values of  $R_F$  and  $R_G$  increase bandwidth and gain peaking. This has the effect of decreasing rise/fall times and increasing overshoot.

#### Ground Connections

For the best isolation and crosstalk rejection, the GND pin and NIC pins must connect to the GND plane.

### Control Signals

S0,  $\overline{\text{ENABLE}}$ , HIZ - These pins are TTL/CMOS compatible control inputs. The S0 pin selects which one of the inputs connect to the output. The  $\overline{\text{ENABLE}}$ , HIZ pins are used to disable the part to save power and three-state the output amplifiers, respectively. For control signal rise and fall times less than 10ns the use of termination resistors close to the part will minimize transients coupled to the output.

### Power-Up Considerations

The ESD protection circuits use internal diodes from all pins the V+ and V- supplies. In addition, a dV/dT-triggered clamp is connected between the V+ and V- pins, as shown in the Equivalent Circuits 1 through 4 section of the Pin Description table. The dV/dT triggered clamp imposes a maximum supply turn-on slew rate of 1V/μs. Damaging currents can flow for power supply rates-of-rise in excess of 1V/μs, such as during hot plugging. Under these conditions, additional methods should be employed to ensure the rate of rise is not exceeded.

Consideration must be given to the order in which power is applied to the V+ and V- pins, as well as analog and logic input pins. Schottky diodes (Motorola MBR0550T or equivalent) connected from V+ to ground and V- to ground (Figure 24) will shunt damaging currents away from the internal V+ and V- ESD diodes in the event that the V+ supply is applied to the device before the V- supply.

If positive voltages are applied to the logic or analog video input pins before V+ is applied, current will flow through the internal ESD diodes to the V+ pin. The presence of large decoupling capacitors and the loading effect of other circuits connected to V+, can result in damaging currents through the ESD diodes and other active circuits within the device. Therefore, adequate current limiting on the digital and analog inputs is needed to prevent damage during the time the voltages on these inputs are more positive than V+.

### HIZ State

An internal pull-down resistor connected to the HIZ pin ensures the device will be active with no connection to the HIZ pin. The HIZ state is established within approximately 25ns (Figure 19) by placing a logic high (>2V) on the HIZ pin. If the HIZ state is selected, the output is a high impedance 1.4MΩ. Use this state to control the logic when more than one mux shares a common output.

In the HIZ state the output is three-stated, and maintains its high Z even in the presence of high slew rates. The supply current during this state is basically the same as the active state.

### ENABLE & Power Down States

The enable pin is active low. An internal pull-down resistor ensures the device will be active with no connection to the  $\overline{\text{ENABLE}}$  pin. The Power Down state is established when a logic high (>2V) is placed on the  $\overline{\text{ENABLE}}$  pin. In the Power Down state, the output has no leakage but has a large capacitance (on the order of 15pF), and is capable of being back-driven. Under this condition, large incoming slew rates can cause fault currents of tens of mA. **Do not use this state as a high Z state for applications driving more than one mux on a common output.**

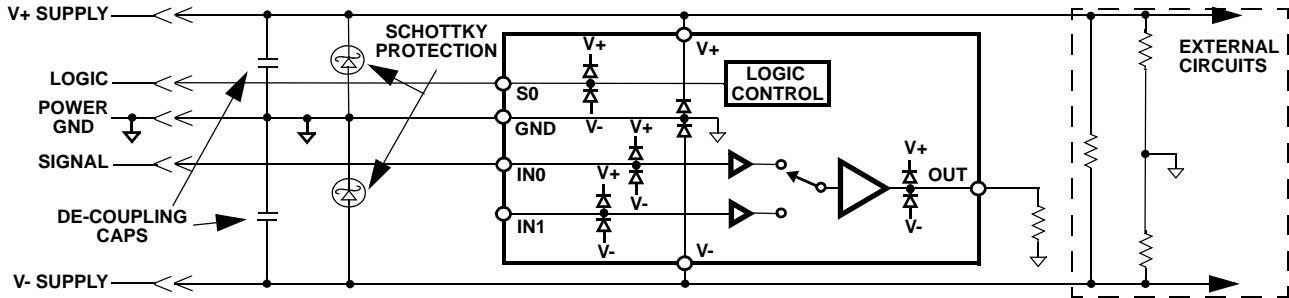

FIGURE 27. SCHOTTKY PROTECTION CIRCUIT

## Limiting the Output Current

No output short circuit current limit exists on this part. All applications need to limit the output current to less than 50mA. Adequate thermal heat sinking of the parts is also required.

## PC Board Layout

The frequency response of this circuit depends greatly on the care taken in designing the PC board. The following are recommendations to achieve optimum high frequency performance from your PC board.

- The use of low inductance components such as chip resistors and chip capacitors is strongly recommended.
- Minimize signal trace lengths. Trace inductance and capacitance can easily limit circuit performance. Avoid sharp corners, use rounded corners when possible. Vias in the signal lines add inductance at high frequency and should be avoided. PCB traces greater than 1" begin to exhibit transmission line characteristics with signal rise/fall times of 1ns or less. High frequency performance may be degraded for traces greater than one inch, unless strip lines are used.
- Match channel-channel analog I/O trace lengths and layout symmetry. This will minimize propagation delay mismatches.
- Maximize use of AC de-coupled PCB layers. All signal I/O lines should be routed over continuous ground planes (i.e. no split planes or PCB gaps under these lines). Avoid vias in the signal I/O lines.
- Use proper value and location of termination resistors. Termination resistors should be as close to the device as possible.
- When testing use good quality connectors and cables, matching cable types and keeping cable lengths to a minimum.
- Minimum of 2 power supply de-coupling capacitors are recommended (1000pF, 0.01μF) as close to the device as possible. Avoid vias between the cap and the device because vias add unwanted inductance. Larger caps can be farther away. When vias are required in a layout, they should be routed as far away from the device as possible.

## Revision History

The revision history provided is for informational purposes only and is believed to be accurate, but not warranted. Please go to web to make sure you have the latest revision.

DATE	REVISION	CHANGE
May 22, 2012	FN7459.2	Updated datasheet to new Intersil template. Changed max "Supply Current" on page 3 from 13mA to 15mA .
September 22, 2005	FN7459.1	1. Edits to the Absolute Max Ratings table included increasing Input Voltage specs to 0.5V from 0.3V, and increasing Digital & Analog Max input current from 5mA to 50mA 2. Expanded PowerUp Considerations by adding the Shottky Diode application circuit and expanded description. 3. Added Part Marking to Ordering Information Table.
June 27, 2005	FN7459.0	Initial Release

## Products

Intersil Corporation is a leader in the design and manufacture of high-performance analog semiconductors. The Company's products address some of the industry's fastest growing markets, such as, flat panel displays, cell phones, handheld products, and notebooks. Intersil's product families address power management and analog signal processing functions. Go to [www.intersil.com/products](http://www.intersil.com/products) for a complete list of Intersil product families.

For a complete listing of Applications, Related Documentation and Related Parts, please see the respective device information page on intersil.com: [ISL59420](http://www.intersil.com/ISL59420)

To report errors or suggestions for this datasheet, please go to: [www.intersil.com/askourstaff](http://www.intersil.com/askourstaff)

FITs are available from our website at: <http://rel.intersil.com/reports/sear>

For additional products, see [www.intersil.com/product\\_tree](http://www.intersil.com/product_tree)

Intersil products are manufactured, assembled and tested utilizing ISO9000 quality systems as noted in the quality certifications found at [www.intersil.com/design/quality](http://www.intersil.com/design/quality)

*Intersil products are sold by description only. Intersil Corporation reserves the right to make changes in circuit design, software and/or specifications at any time without notice. Accordingly, the reader is cautioned to verify that data sheets are current before placing orders. Information furnished by Intersil is believed to be accurate and reliable. However, no responsibility is assumed by Intersil or its subsidiaries for its use; nor for any infringements of patents or other rights of third parties which may result from its use. No license is granted by implication or otherwise under any patent or patent rights of Intersil or its subsidiaries.*

For information regarding Intersil Corporation and its products, see [www.intersil.com](http://www.intersil.com)

Package Outline Drawing

M10.118A (JEDEC MO-187-BA)

10 LEAD MINI SMALL OUTLINE PLASTIC PACKAGE (MSOP)

Rev 0, 9/09

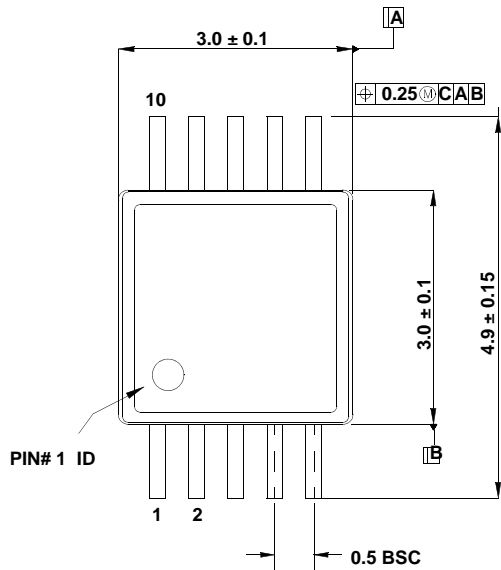

TOP VIEW

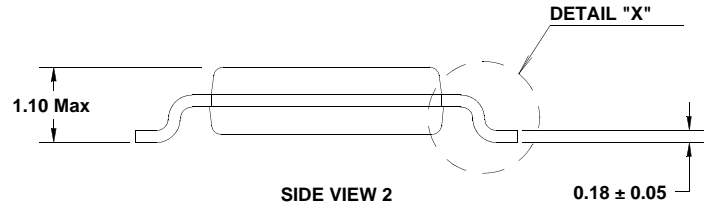

SIDE VIEW 2

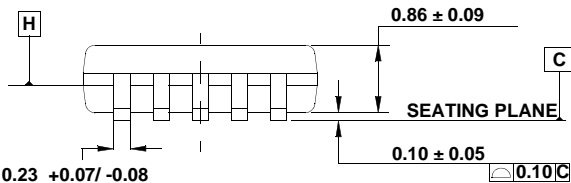

SIDE VIEW 1

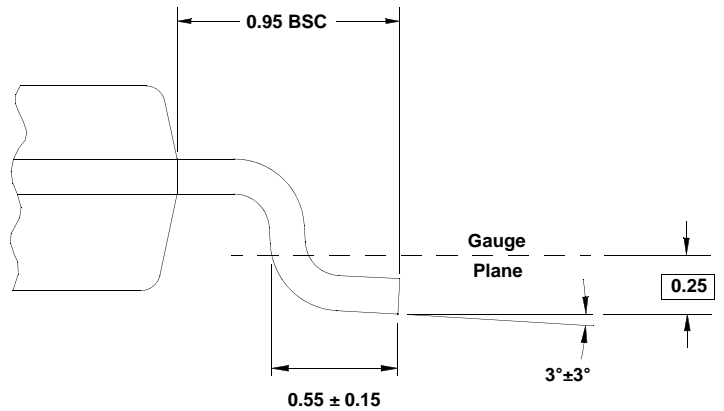

DETAIL "X"

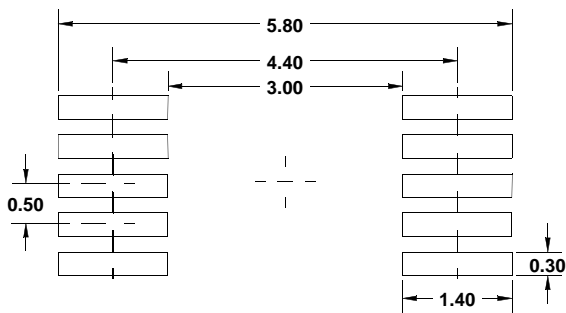

TYPICAL RECOMMENDED LAND PATTERN

NOTES:

1. Dimensions are in millimeters.
2. Dimensioning and tolerancing conform to AMSE Y14.5m-1994.
3. Plastic or metal protrusions of 0.15mm max per side are not included.
4. Plastic interlead protrusions of 0.25mm max per side are not included.
5. Dimensions "D" and "E1" are measured at Datum Plane "H".
6. This replaces existing drawing # MDP0043 MSOP10L.