

OMRON



Pushbutton Switches



realizing

ASIA/OCEANIA

JAPAN

- **OMRON CORPORATION (Industrial)**
Gate City Ohsaki, West Tower 14F, 1-11-1 Ohsaki, Shinagawa-ku, Tokyo, 141-0032 *JAPAN*
Tel: 81-3-3779-9001/Fax: 81-3-3779-9019
- **OMRON CORPORATION (Consumer & Commercial)**
Gate City Ohsaki, West Tower 14F, 1-11-1 Ohsaki, Shinagawa-ku, Tokyo, 141-0032 *JAPAN*
Tel: 81-3-3779-8709/Fax: 81-3-3779-9047

CHINA

- **OMRON (CHINA) CO., LTD. BEIJING OFFICE**
32F, Tower B, Jianwai SOHO #39, East 3rd. Ring Road, Chaoyang District, Beijing, 100022 *CHINA*
Tel: 86-10-5869-3030/Fax: 86-10-5869-3815
- **OMRON ELECTRONIC COMPONENTS (HONG KONG) LTD. BEIJING OFFICE**
32/F, Tower A, Jianwai SOHO, #39, East 3rd. Ring Road, Chaoyang District, Beijing, 100022 *CHINA*
Tel: 86-10-5869-3131/Fax: 86-10-5869-0228
- **OMRON ELECTRONIC COMPONENTS (HONG KONG) LTD. SHANGHAI OFFICE**
Room 2211, Bank of China Tower, 200 Yin Cheng Zhong Road, PuDong New Area, Shanghai, 200120 *CHINA*
Tel: 86-21-5037-2222/Fax: 86-21-5037-2200
- **OMRON (CHINA) CO., LTD. SHANGHAI OFFICE**
Room 2503, Raffles City Shanghai (Office Tower), No. 268 Xi Zang Middle Road, Huang Pu District, Shanghai, 200001 *CHINA*
Tel: 86-21-6340-3737/Fax: 86-21-6340-3757
- **OMRON ELECTRONICS GUANGZHOU LTD.**
Room 2103, Guangzhou China Mayors Plaza, No. 189, Tian He Bei Road, Guangzhou *CHINA*
Tel: 86-20-8732-0508/Fax: 86-20-8732-1750
- **OMRON ELECTRONIC COMPONENTS (HONG KONG) LTD. SHENZHEN OFFICE**
Room 106, SEG Plaza, Huaqiang North Road, Futian District, Shenzhen, 518031 *CHINA*
Tel: 86-755-8346-2220/Fax: 86-755-8346-2230

HONG KONG

- **OMRON ELECTRONICS ASIA LTD.**
Unit 601-9, Tower 2, The Gateway No. 25, Canton Road, Tsimshatsui, Kowloon *HONG KONG*
Tel: 852-2375-3877/Fax: 852-2375-1475
- **OMRON ELECTRONIC COMPONENTS (HONG KONG) LTD.**
Unit 601-9, Tower 2, The Gateway No. 25, Canton Road, Tsimshatsui, Kowloon, *HONG KONG*
Tel: 852-2375-3827/Fax: 852-2375-1475

INDIA

- **OMRON ASIA PACIFIC PTE. LTD. INDIA LIAISON OFFICE**
M-45, Market Complex, Greater Kailash Part II, New Delhi-110048 *INDIA*
Tel: 91-11-5163-8215/Fax: 91-11-5163-8218
- **OMRON ELECTRONIC COMPONENTS PTE LTD, INDIA LIAISON OFFICE**
2nd Floor, Pathi Towers, No. 80-55 East End 'B' Main Road, Jayanagar IX Block, (Nr. Jayadeva Cardiac Institute), Bangalore 560 069, *INDIA*
Tel: 91-80-5696-9638/Fax: 91-80-2663-1685

INDONESIA

- **PT. OMRON ELECTRONICS**
Graha Pratama Floor 3A, JL MT Haryono Kav. 15, Jakarta Selatan *INDONESIA 12810*
Tel: 62-21-8370-9555/Fax: 62-21-8370-9550
- **PT. OMRON MANUFACTURING OF INDONESIA**
EJIP Industrial Park Plot 5C, Lemahabang Bekasi 17550, Jakarta *INDONESIA*
Tel: 62-21-897-5108/Fax: 62-21-897-5160

SOUTH KOREA

- **OMRON ELECTRONIC COMPONENTS CO.,LTD.**
307, Teheran Office Bldg. #707-38, Yeoksam-dong, Gangnam-gu, Seoul *KOREA*
Tel: 82-2-567-5020/Fax: 82-2-567-5804

MALAYSIA

- **OMRON ELECTRONICS SDN. BHD.**
Unit No. 1101, Level 11, Uptown 1, No. 1, Jalan SS 21/58, Damansara Uptown, 47400 Petaling Jaya, Selangor Darul Ehsan *MALAYSIA*
Tel: 60-3-7688-2888/Fax: 60-3-7688-2833
- **OMRON ELECTRONIC COMPONENTS PTE. LTD.**
3A, Lot 4 Bangunan TH Uptown 3, Damansara Uptown, No.3, Jalan SS21/39, 47400 Petaling Jaya, Selangor Darul Ehsan, *MALAYSIA*
Tel: 60-3-7623-6300/Fax: 60-3-7665-0078

THE PHILIPPINES

- **OMRON ASIA PACIFIC PTE. LTD. MANILA REPRESENTATIVE OFFICE**
2nd Floor, King's Court II Bldg, 2129 Don Chino Roces Avenue, 1231 Makati City, Metro, Manila *THE PHILIPPINES*
Tel: 632-811-2831/Fax: 632-811-2583
- **OMRON MALAYSIA SDN BHD, PHILIPPINES REPRESENTATIVE OFFICE**
U-1103, 11th Floor, ALPAP 2 Building, Investment Cor. Trade Drive, Madrigal Business Park, Alabang Muntinlupa City, *THE PHILIPPINES*
Tel: 632-7723-6677/Fax: 632-7723-665

SINGAPORE

- **OMRON ELECTRONICS PTE. LTD.**
55, Ubi Avenue 1, #05-01 *SINGAPORE 408935*
Tel: 65-6547-6789/Fax: 65-6547-6766
- **OMRON ELECTRONIC COMPONENTS PTE. LTD.**
140 Paya Lebar Road #04-11 A-Z Building *SINGAPORE 409015*
Tel: 65-6848-8800/Fax: 65-6848-8811

TAIWAN

- **OMRON TAIWAN ELECTRONICS INC.**
6F, Home Young Bldg., No. 363, Fu-Shing N. Road, Taipei *TAIWAN ROC*
Tel: 886-2-2715-3331/Fax: 886-2-2712-6712
- **OMRON TAIWAN SYSTEM INC.**
11F, No. 8, Chung Hsiao West Road, Sec 1, Taipei *TAIWAN*
Tel: 886-2-2375-2200/Fax: 886-2-2375-2233
- **OMRON ELECTRONIC COMPONENTS (HONG KONG) LTD. TAIWAN BRANCH (*)**
5F-3, No. 146, Song Jiang Road, Taipei, 10458, *TAIWAN ROC*
Tel: 886-2-2521-2350/Fax: 886-2-2521-0686

THAILAND

- **OMRON ELECTRONICS CO., LTD.**
Rasa Tower 20th Floor, #555 Phaholyothin Rd., Chatuchak, Bangkok 10900 *THAILAND*
Tel: 66-2-937-0500/Fax: 66-2-937-0501
- **OMRON ELECTRONIC COMPONENTS CO., LTD.**
Phaholythin Place Building, 41st Floor, 408/166, Phaholythin Road, Samsen-nai, Phayathai, Bangkok 10400 *THAILAND*
Tel: 66-2-619-0292/Fax: 66-2-619-0624-5

VIETNAM

- **OMRON ASIA PACIFIC PTE. LTD. HANOI/HCM REPRESENTATIVE OFFICE**
2, Lang Ha, 6th Floor Vinaconex Building, Hanoi *VIETNAM*
Tel: 844-831-3121/Fax: 844-831-3122

AUSTRALIA

- **OMRON ELECTRONICS PTY. LTD.**
71 Epping Road, North Ryde, Sydney NSW 2113 *AUSTRALIA*
Tel: 61-2-9878-6377/Fax: 61-2-9878-6981

NEW ZEALAND

- **OMRON ELECTRONICS LTD.**
65 Boston Road, Mt Eden Auckland *NEW ZEALAND*
Tel: 64-9-358-4400/Fax: 64-9-358-4411

NORTH/SOUTH AMERICA

UNITED STATES

- **OMRON ELECTRONICS LLC**
One Commerce Drive Schaumburg, IL 60173-5302 *U.S.A.*
Tel: 1-847-843-7900/Fax: 1-847-843-7787
- **OMRON ELECTRONIC COMPONENTS LLC**
55 East Commerce Drive, Suit B, IL 60173 *U.S.A.*
Tel: 1-847-882-2288/Fax: 1-847-882-2192

CANADA

- **OMRON CANADA INC.**
885 Milner Avenue, Scarborough, Ontario, M1B 5V8 *CANADA*
Tel: 1-416-286-6465/Fax: 1-416-286-6648

BRAZIL

- **OMRON ELECTRONICA DO BRASIL LTDA.**
Av. Santa Catarina, 935 04378-300 São Paulo-SP-*BRAZIL*
Tel: 55-11-5564-6488/Fax: 55-11-5564-7751

EUROPE

AUSTRIA

- **OMRON Electronics G.m.b.H**
Brunner Strasse 81, Box 323, A-1230 Vienna *AUSTRIA*
Tel: 43-1-801-90-0/Fax: 43-1-804-48-46

BELGIUM

- **OMRON ELECTRONICS NV/SA**
Stationsstraat 24 B-1702 Groot-Bijgaarden *BELGIUM*
Tel: 32-2-4662-4800/Fax: 32-2-4660-687

CZECH REPUBLIC

- **OMRON ELECTRONICS SpoJ.s.r.o.**
Jankovcova 53, 170 00 *CZECH REPUBLIC*
Tel: 420-234-602-602/Fax: 420-234-602-607

DENMARK

- **OMRON ELECTRONICS A/S**
Lykkebaekvej 2, DK-4600 Koege *DENMARK*
Tel: 45-43-44-0011/45-43-44-0211

FINLAND

- **OMRON ELECTRONICS OY**
Metsänpojanukuja 5, FIN-02130 Espoo *FINLAND*
Tel: 358-207-464-200/Fax: 358-207-464-210

FRANCE

- **OMRON ELECTRONICS S.a.r.l.**
14, Rue de Lisbonne 93561 Rosny Sous Bois *FRANCE*
Tel: 33-1-4974-7000/Fax: 33-1-4876-0930
- **OMRON ELECTRONIC COMPONENTS EUROPE B.V.**
14, Rue de Lisbonne 93561 Rosny Sous Bois *FRANCE*
Tel: 33-1-4974-7050/Fax: 33-1-4876-2795

GERMANY

- **OMRON ELECTRONICS G.m.b.H.**
Elisabeth-Selbert-Strasse 17, 40764 Langenfeld *GERMANY*
Tel: 49-2173-6800-0/Fax: 49-2173-6800-400
- **OMRON ELECTRONIC COMPONENTS EUROPE B.V.**
Gruber Strasse 60d, 85586 Poing *GERMANY*
Tel: 49-8121-77240/Fax: 49-8121-772440

HUNGARY

- **OMRON ELECTRONICS Kft.**
H-1046 Budapest Kiss Erno u. 1-3 *HUNGARY*
Tel: 36-1-399-3050/Fax: 36-1-399-3060

ITALY

- **OMRON ELECTRONICS S.p.a.**
Viale Certosa, 49 20149 Milano *ITALY*
Tel: 39-02-32681/Fax: 39-02-325154
- **OMRON ELECTRONIC COMPONENTS EUROPE B.V.**
Viale Certosa, 49 20149 Milano *ITALY*
Tel: 39-02-3268-850/Fax: 39-02-3268-851

THE NETHERLANDS

- **OMRON ELECTRONICS B.V.**
Wegalaan 61, 2132 JD Hoofddorp, Postbus 582 2130 AN Hoofddorp *THE NETHERLANDS*
Tel: 31-23-568-1100/Fax: 31-23-568-1188
- **OMRON ELECTRONIC COMPONENTS EUROPE B.V.**
Wegalaan 57, 2132 JD Hoofddorp *THE NETHERLANDS*
Tel: 31-23-568-1200/Fax: 31-23-568-1212

NORWAY

- **OMRON ELECTRONICS NORWAY AS**
Ole Deviksvæi 4, P. O. Box 109, Bryn, N-0611 Oslo *NORWAY*
Tel: 47-2265-7500/Fax: 47-2265-8300

POLAND

- **OMRON ELECTRONICS SP.Z.O.O**
ul. Jana Sengera "Cichego" 1, 02-790 Warsaw *POLAND*
Tel: 48-22-645-7860/Fax: 48-22-645-7863

PORTUGAL

- **OMRON ELECTRONICS LDA.**
Rua de S. Tomé, Lote 131 2689-510 Prior-Velho *PORTUGAL*
Tel: 351-21-942-9400/Fax: 351-21-941-7899

SPAIN

- **OMRON ELECTRONICS S.A.**
c/Arturo Soria 95, E-28027 Madrid *SPAIN*
Tel: 34-91-377-7900/Fax: 34-91-377-7956
- **OMRON ELECTRONIC COMPONENTS EUROPE B.V.**
c/Arturo Soria 95, E-28027 Madrid *SPAIN*
Tel: 34-91-377-7900/Fax: 34-91-377-7987

SWEDEN

- **OMRON ELECTRONICS AB**
Norgegatan 1, P. O. Box 1275, SE-164 29 Kista *SWEDEN*
Tel: 46-8-632-3500/Fax: 46-8-632-3510
- **OMRON ELECTRONIC COMPONENTS EUROPE B.V.**
Norgegatan 1, S-164 32 Kista *SWEDEN*
Tel: 46-8-632-3500/Fax: 46-8-632-3535

SWITZERLAND

- **OMRON ELECTRONICS AG**
Sennweidstrasse 44 CH-6312 Steinhausen *SWITZERLAND*
Tel: 41-41-748-1313/Fax: 41-41-748-1345

TURKEY

- **OMRON ELECTRONICS LTD.**
Altunizade, Kiskikli Cad. No: 2 A-Blok K. 2 TR-34662 Uskudar - Istanbul *TURKEY*
Tel: 90-216-474-00-40/Fax: 90-216-474-00-47

UNITED KINGDOM

- **OMRON ELECTRONICS LTD.**
Opal Drive, Fox Milne, Milton Keynes MK15 0DG *UNITED KINGDOM*
Tel: 44-1908-258-258/Fax: 44-1908-258-158
- **OMRON ELECTRONIC COMPONENTS EUROPE B.V.**
1 Bishop Square, Hatfield Business Park, Hatfield, Hertfordshire AL10 9NE *United Kingdom*
Tel: 44-870-750-5661/Fax: 44-870-750-5662

NOTE:

1. Each of OMRON Sales offices has its branch offices.
 2. Some of abovementioned offices do not deal all of OMRON products.
 3. Contron Corporation is an independent distributor in Korea.
 4. Information subject to change without notice.
- This company mainly deals electronic components.

For the most up-to-date office information please visit www.omron.com

Warranty and Application Considerations

Read and Understand this Catalog

Please read and understand this catalog before purchasing the product. Please consult your OMRON representative if you have any questions or comments.

Warranty and Limitations of Liability

Warranty and Limitations of Liability

WARRANTY

OMRON's exclusive warranty is that the products are free from defects in materials and workmanship for a period of one year (or other period if specified) from date of sale by OMRON.

OMRON MAKES NO WARRANTY OR REPRESENTATION, EXPRESS OR IMPLIED, REGARDING NON-INFRINGEMENT, MERCHANTABILITY, OR FITNESS FOR PARTICULAR PURPOSE OF THE PRODUCTS. ANY BUYER OR USER ACKNOWLEDGES THAT THE BUYER OR USER ALONE HAS DETERMINED THAT THE PRODUCTS WILL SUITABLY MEET THE REQUIREMENTS OF THEIR INTENDED USE. OMRON DISCLAIMS ALL OTHER WARRANTIES, EXPRESS OR IMPLIED.

LIMITATIONS OF LIABILITY

OMRON SHALL NOT BE RESPONSIBLE FOR SPECIAL, INDIRECT, OR CONSEQUENTIAL DAMAGES, LOSS OF PROFITS, OR COMMERCIAL LOSS IN ANY WAY CONNECTED WITH THE PRODUCTS, WHETHER SUCH CLAIM IS BASED ON CONTRACT, WARRANTY, NEGLIGENCE, OR STRICT LIABILITY.

In no event shall the responsibility of OMRON for any act exceed the individual price of the product on which liability is asserted.

IN NO EVENT SHALL OMRON BE RESPONSIBLE FOR WARRANTY, REPAIR, OR OTHER CLAIMS REGARDING THE PRODUCTS UNLESS OMRON'S ANALYSIS CONFIRMS THAT THE PRODUCTS WERE PROPERLY HANDLED, STORED, INSTALLED, AND MAINTAINED AND NOT SUBJECT TO CONTAMINATION, ABUSE, MISUSE, OR INAPPROPRIATE MODIFICATION OR REPAIR.

Application Considerations

Application Considerations

SUITABILITY FOR USE

OMRON shall not be responsible for conformity with any standards, codes, or regulations that apply to the combination of products in the customer's application or use of the products.

At the customer's request, OMRON will provide applicable third party certification documents identifying ratings and limitations of use that apply to the products. This information by itself is not sufficient for a complete determination of the suitability of the products in combination with the end product, machine, system, or other application or use.

The following are some examples of applications for which particular attention must be given. This is not intended to be an exhaustive list of all possible uses of the products, nor is it intended to imply that the uses listed may be suitable for the products.

- Outdoor use, uses involving potential chemical contamination or electrical interference, or conditions or uses not described in this catalog.
- Nuclear energy control systems, combustion systems, railroad systems, aviation systems, medical equipment, amusement machines, vehicles, safety equipment, and installations subject to separate industry or government regulations.
- Systems, machines, and equipment that could present a risk to life or property.

Please know and observe all prohibitions of use applicable to the products.

NEVER USE THE PRODUCTS FOR AN APPLICATION INVOLVING SERIOUS RISK TO LIFE OR PROPERTY WITHOUT ENSURING THAT THE SYSTEM AS A WHOLE HAS BEEN DESIGNED TO ADDRESS THE RISKS, AND THAT THE OMRON PRODUCTS ARE PROPERLY RATED AND INSTALLED FOR THE INTENDED USE WITHIN THE OVERALL EQUIPMENT OR SYSTEM.

■ Disclaimers

Disclaimers

PERFORMANCE DATA

Performance data given in this catalog is provided as a guide for the user in determining suitability and does not constitute a warranty. It may represent the result of OMRON's test conditions, and the users must correlate it to actual application requirements. Actual performance is subject to the OMRON *Warranty and Limitations of Liability*.

CHANGE IN SPECIFICATIONS

Product specifications and accessories may be changed at any time based on improvements and other reasons.

It is our practice to change model numbers when published ratings or features are changed, or when significant construction changes are made. However, some specifications of the products may be changed without any notice. When in doubt, special model numbers may be assigned to fix or establish key specifications for your application on your request. Please consult with your OMRON representative at any time to confirm actual specifications of purchased products.

DIMENSIONS AND WEIGHTS

Dimensions and weights are nominal and are not to be used for manufacturing purposes, even when tolerances are shown.

ERRORS AND OMISSIONS

The information in this catalog has been carefully checked and is believed to be accurate; however, no responsibility is assumed for clerical, typographical, or proofreading errors, or omissions.

■ Copyright and Copy Permission

Copyright and Copy Permission

COPYRIGHT AND COPY PERMISSION

This catalog shall not be copied for sales or promotions without permission.

This catalog is protected by copyright and is intended solely for use in conjunction with the products. Please notify us before copying or reproducing this catalog in any manner, for any other purpose. If copying or transmitting this catalog to another, please copy or transmit it in its entirety.

Safety Precautions

■ Meaning of Signal Words

The following signal word is used in this catalog.

 <b style="font-size: 1.2em;">WARNING	Indicates a potentially hazardous situation which, if not avoided, will result in minor or moderate injury, or may result in serious injury or death. Additionally there may be significant property damage.
--	--

■ Meaning of Alert Symbols



The following alert symbol is used in this catalog.

	Indicates the possibility of electric shock under specific conditions.
---	--

■ Alert Statement in this Catalog





The following alert statement applies to the products in this catalog. This alert statement also appears at the locations needed in this catalog to attract your attention.

Please read the *Technical Information* section (page 8) and *Safety Precautions* for each model for other operation precautions.

 <b style="font-size: 1.2em;">WARNING	
Electric shock may possibly occur. Do not perform wiring work or touch the charged parts of terminals while power is supplied to the Switch.	

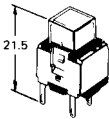
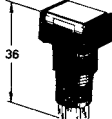
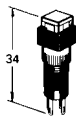

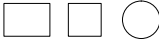



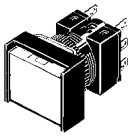
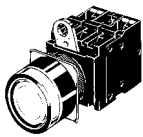
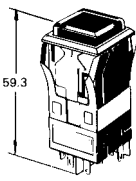
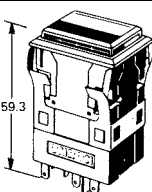

CONTENTS

Selection Guide	5
Technical Information	8
Switches and Indicators with Round Bodies	
A3D	20
M2D	29
A3C	34
M2C	47
A16	55
A165S/W	83
A165K	98
A165E	112
M16	122
M2BJ-B	131
A22	136
A22S/W	166
A22K	177
A22E	184
M22	202
Switches and Indicators with Square Bodies	
A3A	210
A3P	220
M2P	248

Classification	Pushbutton switch		
Model	A3A	A3C	A3D
Appearance			
Pushbutton shape			
Panel cutout dimensions	11.5 × 11.5, 11.5 dia.	12 dia.	8 dia.
Pushbutton color	LED-lighted: red, yellow, green Non-lighted: red, yellow, green, blue, gray, black, light gray, dark gray	LED-lighted: red, yellow, green, white Incandescent lamp-lighted: red, yellow, green, blue, white Non-lighted: red, yellow, green, blue, white, black	LED-lighted: red, yellow, green, white
Indicator type (see note)	NO	YES	YES
Switch color	Black	Black	Black
Form	SPST-NO, SPDT	SPST-NO+ SPST-NC	SPST-NO
Rated load (resistive)	6 A, 125 VAC; 4 A, 30 VDC	0.5 A, 250 VAC; 1 A, 30 VDC	0.1 A, 30 VDC
Mechanical life expectancy	Momentary operation: 1,000 × 10 ³ operations min. Alternate operation: 50 × 10 ³ operations min. (high capacitive load), 100 × 10 ³ operations min. (general-purpose, micro loads)	Momentary operation: 1,000 × 10 ³ operations min. Alternate operation: 100 × 10 ³ operations min.	Momentary operation: 1,000 × 10 ³ operations min. Alternate operation: 100 × 10 ³ operations min.
Electrical life expectancy	50 × 10 ³ operations min. (high capacitive load) 100 × 10 ³ operations min. (general-purpose load) 1,000 × 10 ³ operations min. (micro load)	100 × 10 ³ operations min.	100 × 10 ³ operations min.
Mounting style	Snap-in panel mounting PC board mounted, thru-panel	Nut mounting	Nut mounting
Remarks	Possible to switch wide range of loads	Accessories: socket, insulation cover Series product: micro load type LED & lamp for A16 can be used.	Accessories: socket, insulation cover
Approved standards			---
Page	210	34	20





Note: Indication function only

Selection Guide

Classification	Pushbutton switch, knob-type selector switch, key-type selector switch		Pushbutton switch	
Model	A16	A22	A3PA	A3PJ
Appearance				
Pushbutton shape				
Panel cutout dimensions	16 dia.	22 dia.	23.5 × 22.5	23.5 × 30.5
Pushbutton color	LED-lighted: red, yellow, pure yellow, green, white, blue Incandescent lamp-lighted: red, yellow, green, pure yellow, white, blue Non-lighted: red, yellow, pure yellow, green, white, blue, black	LED-lighted: red, yellow, green, white, blue Incandescent lamp-lighted: red, yellow, green, white, blue Non-lighted: red, yellow, green, white, blue, black	Lighted with built-in LED: red, white, green, orange Incandescent lamp-lighted: red, green, white, blue, orange LED-lighted: red, yellow, green, white (split types and 2-color types also available)	
Indicator type (see note)	YES	YES	YES	
Switch color	Black	Black, brown	Light gray, black	
Form	SPDT, DPDT	SPST-NO, SPST-NC, SPST-NO+SPST-NC, DPST-NO, DPST-NC	SPDT, DPDT	
Rated load (resistive)	5 A, 125 VAC; 3 A, 250 VAC; 3 A, 30 VDC	10 A, 110 VAC; 6 A, 220 VAC	3 A, 250 VAC; 3 A, 30 VDC	
Mechanical life expectancy	<u>Pushbutton Switch</u> Momentary operation: 2,000 x 10 ³ operations min. <u>Knob-type Selector Switch</u> 250 x 10 ³ operations min. <u>Key-type Selector Switch</u> 250 x 10 ³ operations min.	<u>Pushbutton Switch</u> 5,000 x 10 ³ operations min. <u>Knob-type Selector Switch</u> Non-lighted: 500 x 10 ³ operations min. Lighted: 100 x 10 ³ operations min. <u>Key-type Selector Switch</u> 500 x 10 ³ operations min.	Momentary operation: 1,000 x 10 ³ operations min. Alternate operation: 200 x 10 ³ operations min.	
Electrical life expectancy	<u>Pushbutton Switch</u> 100 x 10 ³ operations min. <u>Knob-type Selector Switch</u> 100 x 10 ³ operations min. <u>Key-type Selector Switch</u> 100 x 10 ³ operations min.	<u>Pushbutton Switch</u> 500 x 10 ³ operations min. <u>Knob-type Selector Switch</u> Non-lighted: 500 x 10 ³ operations min. Lighted: 100 x 10 ³ operations min. <u>Key-type Selector Switch</u> 500 x 10 ³ operations min.	100 x 10 ³ operations min.	
Mounting style	Nut mounting	Nut mounting	Snap-in panel mounting	
Remarks	Accessories: extractor, legend plate, screw fitting, panel plug, lock ring	Accessories: contact block, lamp socket, mounting latch, legend plate, metallic bezel ring, sealing cap, control box, snap-in legend plate	Accessories: socket, mounting plate, barrier, switch guard, protective cover Series product: Microload version	
Approved standards				
Page	55	136	220	220

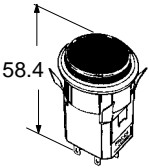
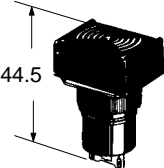
Note: Indication function only

Selection Guide

Classification	Pushbutton switch	Buzzer
Model	A3PT	M2BJ-B
Appearance		
Pushbutton shape		
Panel cutout dimensions	29 dia.	16 dia.
Pushbutton color	LED-lighted: white, red, yellow, green Incandescent lamp-lighted: red, green, white, blue, orange	Non-lighted
Indicator type (see note)	YES	NO
Switch color	Light grey	Black
Form	SPDT, DPDT	---
Rated load (resistive)	3 A, 250 VAC; 5 A, 125 VAC; 5 A, 8 VDC; 5 A, 14 VDC; 4A, 30 VDC; 0.4 A, 125 VDC; 0.2 A, 250 VDC	---
Mechanical life expectancy	Momentary operation: 1,000,000 operations min. Alternate operation: 200,000 operations min.	---
Electrical life expectancy	100,000 operations min.	---
Mounting style	Spring mounting	Nut mounting Snap-in panel mounting
Remarks	Same as the A3PA and A3PJ	Buzzer only Accessories: snap-in mounting leaf spring, panel plug
Approved standards		---
Page	220	131

Note: Indication function only

Technical Information

■ Terms for Configuration and Structure

A Pushbutton Switch is a switch designed so that its contacts are opened and closed by depressing and releasing a pushbutton on the Switch in the direction of its axis. Pushbutton Switches come in two categories: lighted and non-lighted. The structure of a typical Lighted Pushbutton Switch is shown below. Broadly speaking, Lighted Pushbutton Switches are made up of the 5 sections shown below. Non-lighted Pushbutton Switches are made up of 4 sections, the 5 sections shown below less the light source.

Structure of Typical Lighted Pushbutton Switch

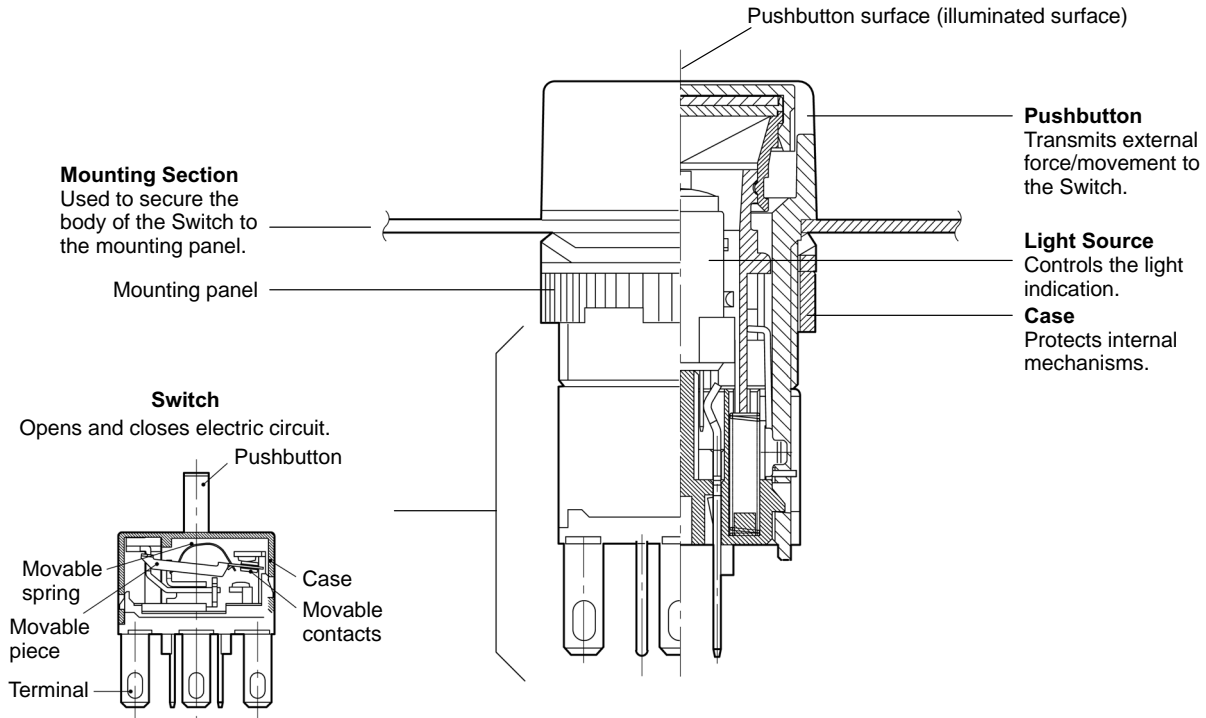

■ Terms for Operating Action

Operation	Explanation
Momentary operation	The pushbutton returns to its original position after it is released.
Alternate operation	The first time the pushbutton is pressed, an internal lock mechanism holds it in the same position. The next time it is pressed, the lock is released and the pushbutton returns to its original position.
Push-pull operation	When the pushbutton is pressed, an internal lock mechanism holds it in the same position. The pushbutton is returned to its original position when the pushbutton is pulled to release the lock.
Push-lock, turn-reset operation	When the pushbutton is pressed, an internal lock mechanism holds it in the same position. The pushbutton is returned to its original position when the pushbutton is twisted to release the lock.

■ Terms Related to Operating Characteristics

Classification	Term	Abbreviation	Unit	Definition
Force	Operating Force	OF	N, N·m	The force (or torque) that must be applied to the pushbutton to move it from the free position to the operating position.
	Releasing Force	RF	N, N·m	The force (or torque) that must be applied to the pushbutton to move it from the operating limit position back to the returned position.
	Total Travel Force	TTF	N, N·m	The force (or torque) on the pushbutton when it reaches the stopper.
Position	Free Position	FP	mm, (°)	The position (or angle) of the pushbutton when there is no external force applied to it.
	Operating Position	OP	mm, (°)	The position (or angle) of the pushbutton when the movable contact changes from the free position state to the operating position state due to an external force.
	Release Position	RP	mm, (°)	The position (or angle) of the pushbutton when the movable contact changes from the operating position state to the free position state due to the reduction of external force.
	Total Travel Position	TTP	mm, (°)	The position (or angle) of the pushbutton when it reaches the stopper.
	Set Position	SP	mm, (°)	The position of an alternate operation pushbutton when it is in the self-holding state, or the position (or angle) of a selector switch when it is in the self-holding state.
Travel	Pretravel	PT	mm, (°)	The distance (or angle) through which the pushbutton moves in going from the free position to the operating position.
	Overtravel	OT	mm, (°)	The distance (or angle) through which the pushbutton moves in going from the operating position to the operating limit position.
	Movement Differential	MD	mm, (°)	The distance (or angle) through which the pushbutton moves in going from the operating position back to the returned position.
	Total Travel	TT	mm, (°)	The distance (or angle) through which the pushbutton moves in going from the free position to the operating limit position.
	Releasing Travel	RT	mm, (°)	The distance (or angle) through which the pushbutton moves in going from the returned position to the free position.
	Lock Travel Alternate	LTA	mm, (°)	The distance (or angle) through which the pushbutton moves in going from the free position to the set position.

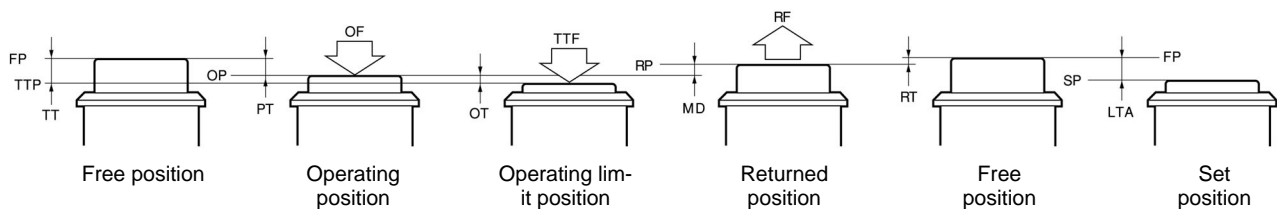

■ Terminal Symbols

Symbol	Meaning
COM	Common terminal
NC	Normally closed terminal
NO	Normally open terminal

■ Contact Form

Name	Contact form
SPDT	
SPST-NC	
SPST-NO	
Double-break	

■ General Terms

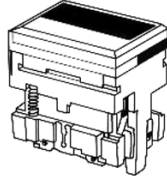
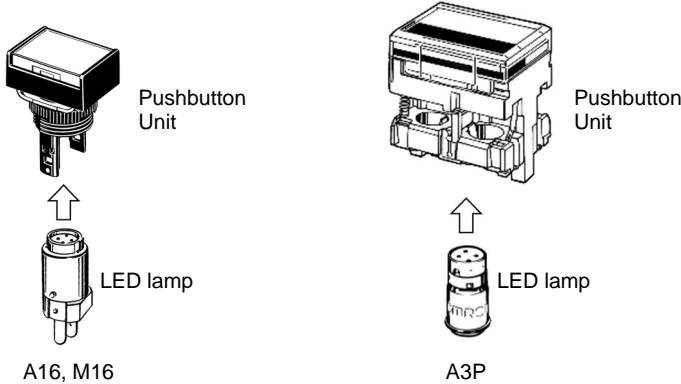
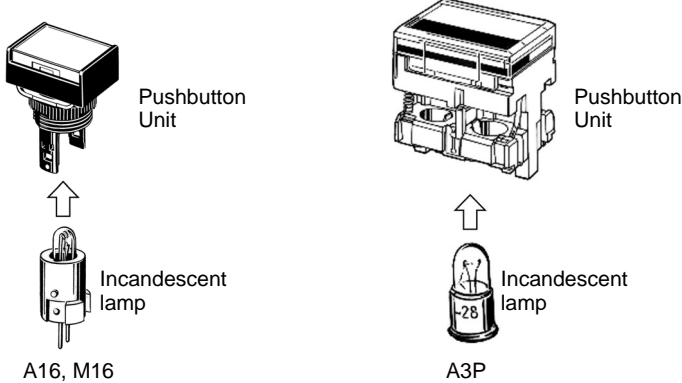
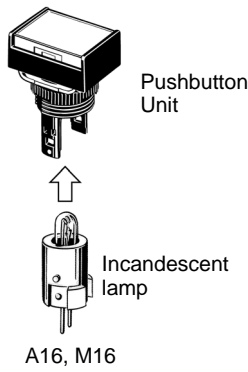
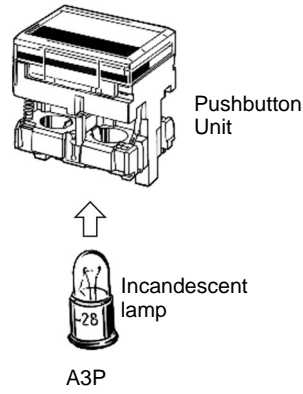
Term	Explanation	
Chameleon lighting	Full-screen lighting in one of 3 colors: red, green, or orange. (Orange is produced by simultaneous illumination of red and green.)	
Simultaneity	This term is used for switches that have more than one contact circuit. It indicates the difference in time or position between the contacts when all the contacts of the switch are opened or closed in one operation.	
LED lighting	<p>LED-lighted models are lit with an LED installed in the base of the Pushbutton Unit.</p> <p>The LED is mounted internally; it cannot be removed.</p> 	
LED-lamp lighting	<p>LED lamp-lighted models use the same light source as incandescent lamp-lighted models, with an LED instead of a filament.</p> <p>The Lamp (i.e., the LED lamp) and the Pushbutton Unit can be separated.</p>  	
Incandescent lamp lighting	<p>Incandescent lamp-lighted models are lit with an incandescent lamp.</p> <p>The Lamp (i.e., the incandescent lamp) and the Pushbutton Unit can be separated.</p>  	
Voltage Reduction Unit	For 16-dia. A16 (M16) models, 22-dia. A22 (M22) models, and 30-dia. A30 models	The Voltage Reduction Unit has a smoothing circuit and a resistance, and lights the LED lamp by applying 110 (220) VAC/VDC directly to the Lamp terminals.
Matrix mounting	Mounting several Switches in vertical and/or horizontal lines.	
Locking Switches	Switches that have the functionality to self-hold when the pushbutton is operated.	
Horizontal side-by-side mounting	Mounting Switches side-by-side with the long side of the Switch (rectangular models) horizontal.	
Vertical side-by-side mounting	Mounting Switches side-by-side with the long side of the Switch (rectangular models) vertical.	



Protection Ratings

Note: International protection degrees are determined by the following tests. Be sure to check the sealing capability under the actual operating environment and conditions before actual use.

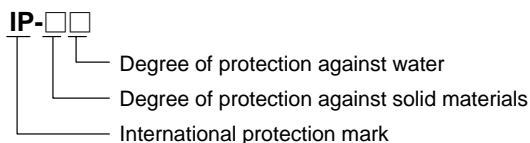





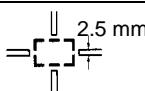
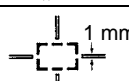
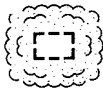
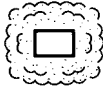



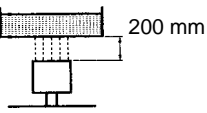

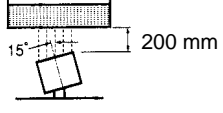

■ IEC (International Electrotechnical Commission) Standards (IEC 60529 January 1997)

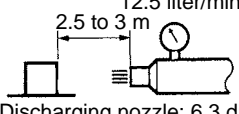

Degree of Protection from Solid Materials

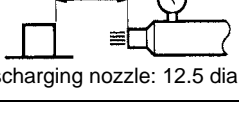
Degree	Protection
0	 No protection
1	 50 mm dia. Protects against penetration of any solid object, such as a hand, that is 50 mm or more in diameter.
2	 12.5 mm dia. Protects against penetration of any solid object, such as a finger, that is 12.5 mm or more in diameter.
3	 2.5 mm Protects against penetration of any solid object, such as a wire, that is 2.5 mm or more in diameter.
4	 1 mm Protects against penetration of any solid object, such as a wire, that is 1 mm or more in diameter.
5	 Protects against penetration of dust of a quantity that may cause malfunction or obstruct the safe operation of the product.
6	 Protects against penetration of all dust.

Degree of Protection Against Water

Degree	Protection		Test method (with fresh water)
0	No protection	Not protected against water.	No test
1	Protection against water drops 	Protects against vertical drops of water towards the product.	Water is dropped vertically towards the product from the test machine for 10 min. 
2	Protection against water drops 	Protects against drops of water approaching at a maximum angle of 15° to the left, right, back, and front of vertical towards the product.	Water is dropped for 2.5 min each (i.e., 10 min in total) towards the product inclined 15° to the left, right, back, and front from the test machine. 
3	Protection against sprinkled water 	Protects against sprinkled water approaching at a maximum angle of 60° from vertical towards the product.	Water is sprinkled at a maximum angle of 60° to the left and right from vertical for 10 min from the test machine Water rate is 0.07 liter/min per hole. 
4	Protection against water spray 	Protects against water spray approaching at any angle towards the product.	Water is sprayed at any angle towards the product for 10 min from the test machine. Water rate is 0.07 liter/min per hole. 
5	Protection against water jet spray 	Protects against water jet spray approaching at any angle towards the product.	Water is jet sprayed at any angle towards the product for 1 min per square meter for at least 3 min in total from the test machine. 12.5 liter/min 2.5 to 3 m  Discharging nozzle: 6.3 dia.
6	Protection against high-pressure water jet spray 	Protects against high-pressure water jet spray approaching at any angle towards the product.	Water is jet sprayed at any angle towards the product for 1 min per square meter for at least 3 min in total from the test machine. 100 liter/min 2.5 to 3 m  Discharging nozzle: 12.5 dia.
7	Protection underwater 	Resists the penetration of water when the product is placed underwater at specified pressure for a specified time.	The product is placed 1 m deep in water (if the product is 850 mm max. in height) for 30 min. 
8	Protection underwater 	Can be used continuously underwater.	The test method is determined by the manufacturer and user.

■ Terms Related to IEC947 and IEC950

No.	Term	Explanation
1	Rated operating voltage (Ue)	VAC: 120, 240, 380, 480, 500, 600 VDC: 125, 250, 440, 500, 600
2	Rated operating current (Ie)	Specified by the manufacturer on consideration of rated operating voltage (Ue), rated frequency, rated energizing time, area of application, and type of enclosure protection.
3	Rated insulation voltage (Ui)	Determined by creepage distance and the dielectric strength. The maximum Ue value must not exceed the maximum Ui value. If there is no Ui value specified, the maximum Ue value is taken as the Ui value.
4	Pollution degree	<ol style="list-style-type: none"> 1. Either no pollutants are present, or only dried, non-conductive pollutants are present (e.g., clean rooms). 2. Basically, only non-conductive pollutants are present, or only transient conductivity occurs due to condensation (indoor locations, such as offices). 3. Conductive pollutants are present, or non-conductive pollutants are present in locations where condensation is expected (e.g., factories). 4. Conductivity due to impurities is a constant possibility, or conductivity is caused by conductive dust, rain, or snow (e.g., outdoor locations).
5	Electric shock protection class	<p>Class I: These devices require grounding. Electric shock is prevented by basic insulation and charged parts that would be subject to dangerously high voltages if the insulation was damaged, are grounded.</p> <p>Class II: Electric shocks are prevented by double insulation or enforced insulation.</p> <p>Class III: No countermeasures against electric shocks are required because the electric circuits in use operate in a low-enough voltage range.</p> <p>Class II: Electric shocks are prevented by double insulation or enforced insulation.</p> <p>Class III: No countermeasures against electric shocks are required because the electric circuits in use operate in a low-enough voltage range.</p>
6	PTI	Proof tracking index. Specified CTI values (comparative tracking indices): Materials satisfying the 175, 250, 300, 375, and 500 levels are denoted as PTI-175, PTI-250, PTI-300, PTI-375, and PTI-500 respectively.
7	IP	<p>IP-□□</p> <p>Degree of protection against water (See below.)</p> <p>Degree of protection against solid materials (See below.)</p>

Degree of Protection

The meanings of the IP numbers are given in the following table.

No.	Degree of protection against solid materials	Degree of protection against water
0	No protection	No protection
1	Protects against penetration of any solid object, such as a hand, that is 50 mm or more in diameter.	Protects against vertical drops of water.
2	Protects against penetration of any solid object, such as a finger, that is 12.5 mm or more in diameter.	Protects against drops of water approaching at a maximum angle of 15° to the vertical.
3	Protects against penetration of any solid object, such as a wire, that is 2.5 mm or more is diameter.	Protects against sprinkled water.
4	Protects against penetration of any solid object, such as a wire, that is 1 mm or more in diameter.	Protects against water spray.
5	Protects against penetration of dust of a quantity that may cause malfunction or obstruct the safe operation of the product.	Protects against water jet spray.
6	Protects against penetration of all dust.	Protects against high-pressure water jet spray.

Common Precautions

For the individual precautions for a Switch, refer to the precautions in the section for that Switch.

Cautions

Do not perform wiring or touch the charged parts of terminals while power is being supplied to the Switch. Doing so may result in electric shock.

Electrical Characteristics

Electrical Conditions

- The switching load capacity of the Switch greatly varies between AC and DC. Always be sure to apply the rated load. The control capacity will drastically drop if it is a DC load. This is because a DC load has no current zero-cross point, unlike an AC load. Therefore, if an arc is generated, it may continue for a comparatively long time. Furthermore, the current direction is always the same, which results in a contact relocation phenomena whereby the contacts easily stick to each other and do not separate when the surfaces of the contacts are uneven.
- Some types of load have a great difference between normal current and inrush current. Make sure that the inrush current is within the permissible value. The greater the inrush current in the closed circuit is, the greater the contact abrasion or shift will be. Consequently, contact weld, contact separation failures, or insulation failures may result. Furthermore, the Switch may be broken or damaged.
- If the load is inductive, counter-electromotive voltage will be generated. The higher the voltage is, the higher the generated energy will be, which will increase the abrasion of the contacts and contact relocation phenomena. Be sure to use the Switch within the rated conditions.

Inrush Current

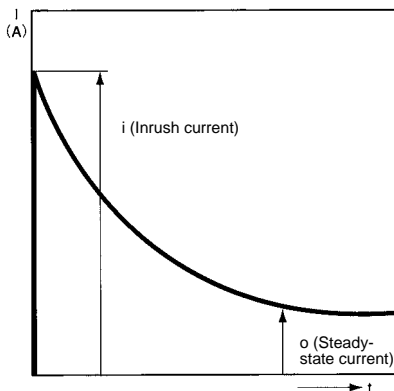

- Approximate control capacities are given in ratings tables, but these alone are insufficient to guarantee correct operation. For special types of load, with unusual switching voltage or current waveforms, test whether correct operation is possible with the actual load before application.
- When switching for microloads (voltage or current), use a Switch with microload specifications. The reliability of silver-plated contacts, which are used in Switches for standard loads, will be insufficient for microloads.
- When switching microloads or very high loads that are beyond the switching capacity of the Switch, connect a relay suitable for the load.

Type of Load vs. Inrush Current

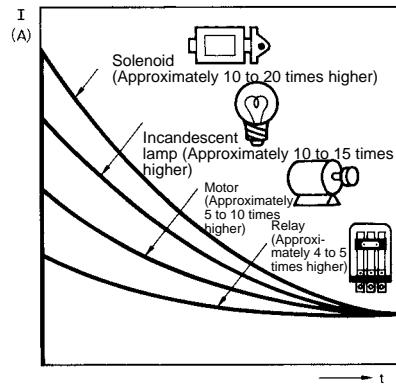

- All the performance ratings given are for operation under the following conditions unless otherwise specified.
 - Inductive load: A minimum power factor of 0.4 (AC) and a maximum time constant of 7 ms (DC)
 - Lamp load: An inrush current 10 times higher than the steady-state current
 - Motor load: An inrush current 6 times higher than the steady-state current
- Note:** Inductive loads can cause problems especially in DC circuitry. Therefore, it is essential to know the time constants (L/R) of the load.

Load Connections

Do not connect a single Switch to two power supplies that are different in polarity or type.

Connection of Different Polarities

The power supply may short-circuit if the loads are connected in the way shown in the "incorrect" example below.

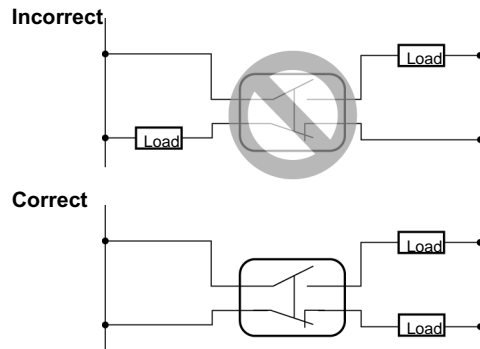

Even in the "correct" example, note that the insulation performance of the switch may deteriorate and the switch life may be shortened because loads are connected to both contacts.

Connection of Different Power Supplies

The DC and AC power may be mixed for the circuit shown below.

Do not design a circuit where voltage is imposed between contacts, otherwise contact weld may result.

Incorrect

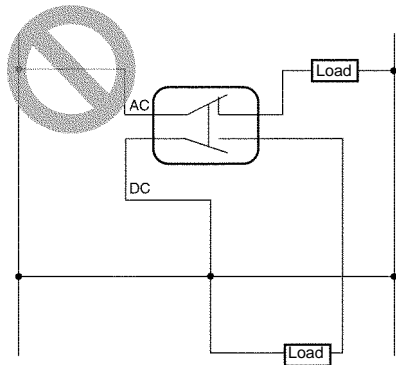

Incorrect

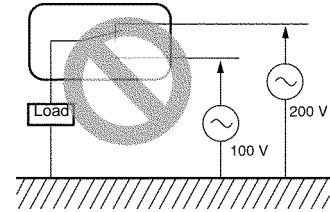

Contact Protective Circuit

Apply a contact protective circuit to extend the contact life, prevent noise, and suppress the generation of carbide or nitric acid. Be sure to apply the contact protective circuit correctly, otherwise an adverse effect may occur.

The following provides typical examples of contact protective circuits. If the Limit Switch is used in an excessively humid location for switching a load that easily generates arcs, such as an inductive load, the arcs may generate NO_x, which will change into HNO₃ if it reacts with moisture. Consequently, the internal metal parts may corrode and the Limit Switch may fail. Be sure to select the ideal contact preventive circuit from the following.

Typical Examples of Contact Protective Circuits

Circuit example	Applicable current		Feature	Element selection	
	AC	DC			
	*	Yes	*When AC is switched, the load impedance must be lower than the CR impedance.	C: 1 to 0.5 μF x switching current (A) R: 0.5 to 1 Ω x switching voltage (V) The values may change according to the characteristics of the load. The capacitor suppresses the spark discharge of current when the contacts are open. The resistor limits the inrush current when the contacts are closed again. Consider the roles of the capacitor and resistor and determine ideal capacitance and resistance values through testing. Basically, use a capacitor with a dielectric strength between 200 and 300 V. When AC is switched, make sure that the capacitor has no polarity.	
		Yes	Yes		The operating time will be greater if the load is a relay or solenoid. Connecting the CR circuit in parallel to the load is effective when the power supply voltage is 24 or 48 V and in parallel to the contacts when the power supply voltage is 100 to 200 V.
Diode method		No	Yes	Energy stored in the coil is changed into current by the diode connected in parallel to the load. Then the current flowing to the coil is consumed and Joule heat is generated by the resistance of the inductive load. The reset time delay with this method is longer than that in the CR method.	The diode must withstand a peak inverse voltage 10 times higher than the circuit voltage and a forward current as high or higher than the load current.
Diode and Zener diode method		No	Yes	This method will be effective if the reset time delay caused by the diode method is too long.	Use a Zener diode with a Zener voltage that is approximately 1.2 x power supply voltage as, depending on the environment, the load may not operate.
Varistor method		Yes	Yes	This method makes use of constant-voltage characteristic of the varistor so that no high-voltage is imposed on the contacts. This method causes a reset time delay. Connecting a varistor in parallel to the load is effective when the supply voltage is 24 to 48 V and in parallel to the contacts when the supply voltage is 100 to 200 V.	---

Do not apply contact protective circuits as shown below.

Incorrect

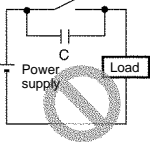

This circuit effectively suppresses arcs when the contacts are OFF. The capacitor will be charged, however, when the contacts are OFF. Consequently, when the contacts are ON again, short-circuited current from the capacitance may cause contact weld.

Incorrect

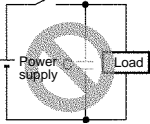

This circuit effectively suppresses arcs when the contacts are OFF. When the contacts are ON again, however, charge current will flow to the capacitor, which may result in contact weld.

Switching a DC inductive load is usually more difficult than switching a resistive load. By using an appropriate contact protective circuit, however, switching a DC inductive load will be as easy as switching a resistive load.

Switching

- Do not use the Switch for loads that exceed the rated switching capacity or other contact ratings. Doing so may result in contact weld, contact separation failures, or insulation failures. Furthermore, the Switch may be broken or damaged.
- Do not touch the charged switch terminals while power is supplied, otherwise an electric shock may be received.
- The life of the Switch varies greatly with switching conditions. Before using the Switch, be sure to test the Switch under actual conditions. Make sure that the number of switching operations is within the permissible range. If a deteriorated Switch is used continuously, insulation failures, contact weld, contact failures, switch damage, or switch burnout may result.
- Do not apply excessive or incorrect voltages to the Switch or incorrectly wire the terminals. Otherwise, the Switch may not function properly and have an adverse effect on external circuitry. Furthermore, the Switch itself may become damaged or burnt.
- Do not use the Switch in locations where flammable or explosive gases are present. Otherwise switching arcs or heat radiation may cause a fire or explosion.
- Do not drop or disassemble the Switch, otherwise it may not be capable of full performance. Furthermore, it may be broken or burnt.

Mechanical Conditions

Operating Force and Operating Method

- Fingertip operation is an important feature of Pushbutton Switches. In terms of Switch operation, Pushbutton Switches differ greatly from detection switches such as Microswitches. Operating the Switch using a hard object (e.g., metal), or with a large or sudden force, may deform or damage the Switch, resulting in faulty or rough operation, or shortening of the Switch life. The strength varies with the size and construction of the Switch. Use the appropriate Switch for the application after confirming the operating method and operating force with this catalog.

Incorrect

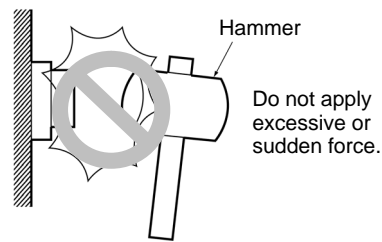

Do not apply excessive or sudden force.

- The pushbutton surface is composed of resin. Therefore, do not attempt to operate the pushbutton using a sharp object, such as a screwdriver or a pair of tweezers. Doing so may damage or deform the pushbutton surface and result in faulty operation.

Incorrect

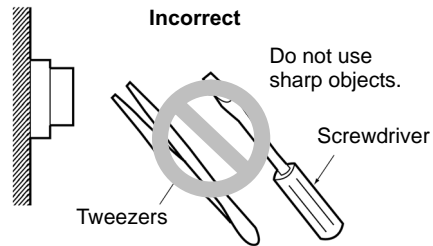

Do not use sharp objects.

Mounting

- Switches can be broadly divided into two categories according to mounting method: panel-mounting models and PCB-mounting models. Use the appropriate model for the mounting method required. Basically, panel-mounting Switches can withstand a greater operating force than PCB-mounting Switches. If, however, the panel thickness or the panel-cutout dimensions are not suitable for the Switch, it may not be able to withstand the normal operating force. With continuous mounting in particular, select a panel of a thickness that is easily sufficient to withstand the total operating force.
- Panel-mounting Switches can be divided into two categories according to the mounting method: snap-in mounting models and screw-mounting models. Snap-in mounting Switches are held in place with the elasticity of resin or a metal leaf spring. Do not attempt to modify the spring after mounting. Doing so may result in faulty operation or damage the mounting structure. Mount screw-mounting models using the screws and nuts provided (or individually specified). Tighten the screws to the specified torque. Mounting with different screws or nuts, or tightening beyond the specified torque may result in distortion of the inside of the case or damage to the screw section.

Snap-in Mounting

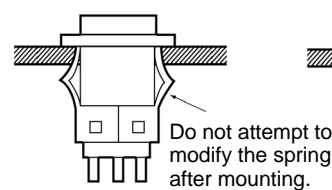

Do not attempt to modify the spring after mounting.

Screw Mounting

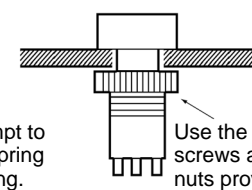

Use the screws and nuts provided (or specified).

- Subjecting the Switch to severe vibrations or shock may result in faulty operation or damage. Also, many of the Switches are

composed of resin so contact with sharp objects may result in damage to the surface. This kind of damage may spoil the appearance of the Switch or result in faulty operation. Do not throw or drop the Switch.

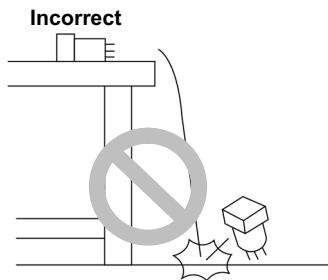

Do not drop or knock the Switch.

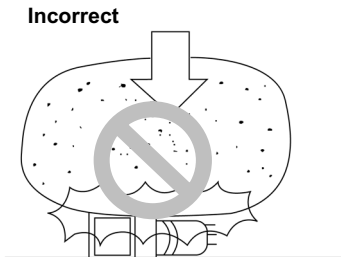

Do not drop objects or place heavy objects on the Switch.

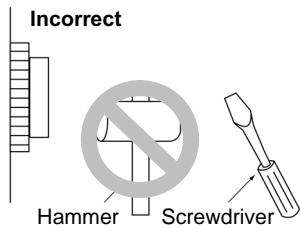

Do not operate the Switch with heavy or sharp objects.

Mounting Precautions

Wiring

- Perform wiring so that the lead wires will not be caught on other objects as this will cause stress on the Switch terminals. Wire the Switch so that there is slack in the lead wires and fix lead wires at intermediate points. If the panel to which the Switch is mounted needs to be opened and closed for maintenance purposes, perform wiring so that the opening and closing of the panel will not interfere with the wiring.

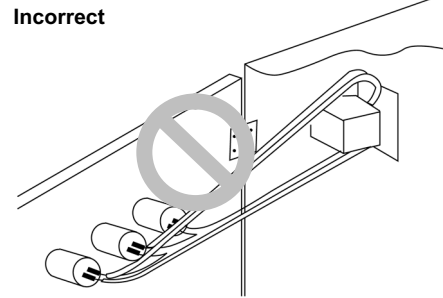
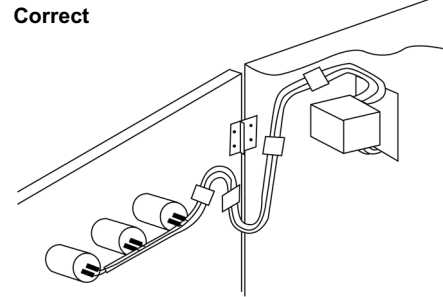

- With miniature Switches, the gap between the terminals is very narrow. Use protective or heat-absorbing tubes to prevent burning of the wire sheath or shorting.

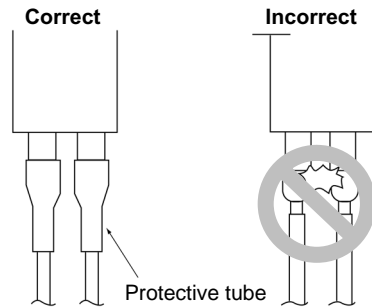

Soldering

- There are two methods for soldering the Switch: hand soldering and automatic soldering. In addition, automatic soldering itself can be divided into two types : dip soldering and reflow soldering. Use the soldering method appropriate for the mounting method. The following table gives some examples of applications using the types of soldering given above.

Method		Soldering device	Application
Hand soldering		Soldering iron	Small quantities Different materials Lead wire terminals
Automatic soldering	Dip soldering	Jet soldering bath Dip soldering bath	Large quantities of discrete terminals
	Reflow soldering	Infrared reflow (IR) soldering bath Vapor-phase (VPS) reflow soldering bath	Large quantities of miniature SMD terminals

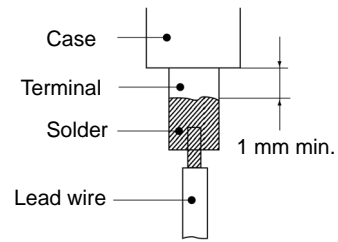

- Do not use soldering flux that contains chlorine. Doing so may result in metal corrosion.
- Perform hand soldering using the appropriate soldering iron.

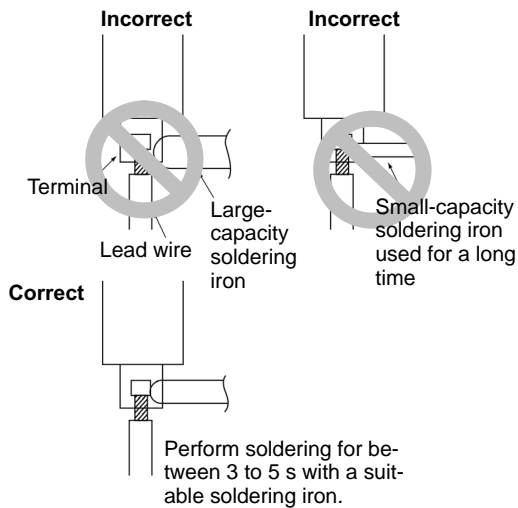

- With the exception of PCB-mounting Switches, when performing hand soldering, hold the Switch so that the terminals point downwards so that flux does not get inside the Switch.

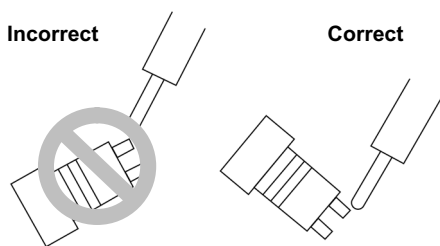

- Leave a gap of at least 1 mm between the soldered parts and the surface of the case so that flux does not get inside the Switch.

- When applying flux using a brush, use a sponge soaked in flux as shown below. Do not apply more than is necessary. Also, apply the flux with the PCB inclined at an angle of less than 80° so that flux does not flow onto the mounting surface of the Switch.

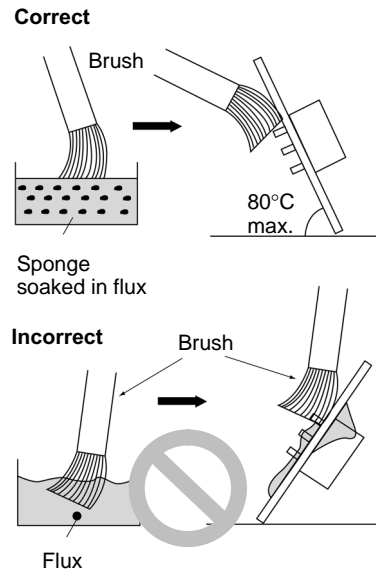

- Do not place PCBs that have had flux applied or have been soldered on top of each other. Otherwise, the flux on the PCB's solder surface may stain the upper part of the Switch or even permeate the inside of the Switch and cause contact failure.

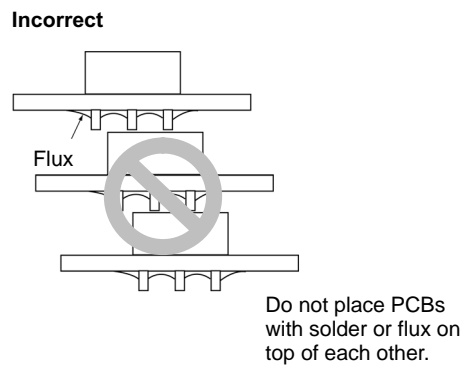

- When performing soldering with a dip soldering bath, ensure that the flux does not reach a higher level than the PCB.

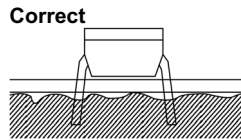
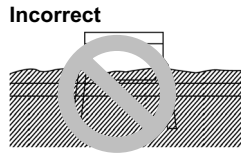

- Flux is especially likely to rise up at the edges of the PCB. If the Switch is mounted near the edge of the PCB, create a gap between the edge by using a split PCB, and insert the PCB in the soldering bath so that the edge that is farthest from the Switch enters the bath first.

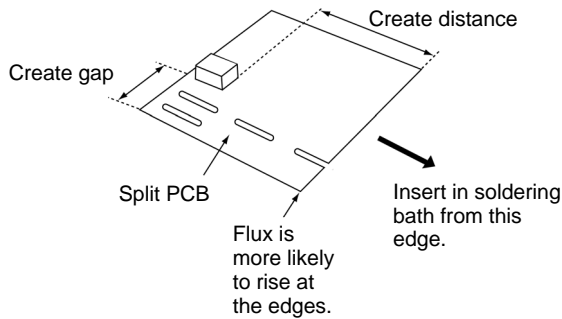

Storage

- When the Switch is left unused or stored for long periods, the ambient conditions can have a great effect on the condition of the Switch. In certain environments, leaving the Switch exposed may result in deterioration (i.e., oxidation, or the creation of an oxide film) of the contacts and terminals, causing the contact resistance to increase, and making it difficult to solder the lead wires. Therefore, store in a well-ventilated room, inside, for example, a non-hygroscopic case, in a location where no corrosive gases are present.

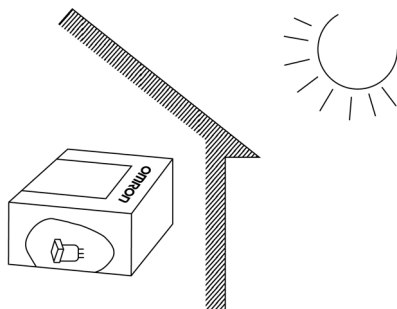

- If the Switch is stored in a location where it will be exposed to direct light, colored resin in the colored plate may fade. Therefore, do not store the Switch in locations where it will be exposed to direct light.

Lighted Pushbutton Switch

A3D

Lighted Pushbutton Switch with Cylindrical 18-mm × 8-dia. Body

- Good illumination with even surface brightness.
- Cylindrical body means panel cutouts can be made easily.
- Combines miniature design with excellent operating sensitivity.



Ordering Information

■ Model Number Legend:

The model numbers used to order sets of Units are illustrated below. One set comprises the Pushbutton (LED lamp built-in) and Switch.

(1) (2) (3)

A 3 D J - 9 0 A 1 - 0 0 E R

(1) Shape of Pushbutton

Symbol	Shape
J	Rectangular
A	Square
T	Round

(2) Switch Specifications
Microload (30 VDC, 0.1 A)

Symbol	Terminals	Operation	Contact
A	Solder	Momentary	SPST-NO
B		Alternate	

Minimum applicable load: 1 mA at 5 VDC

Standard load models are not available.

If PCB terminals are required, use the Socket given under *Accessories* on page 22.

Momentary operation: Self-resetting
Alternate operation: Self-holding

(3) Color of Pushbutton



Symbol	Color
R	Red
Y	Yellow
G	Green
W	White

All models are illumination only. Colored-illumination models are not available.

Non-lighted models are not available.

An external resistor is required. (Refer to page 28.)

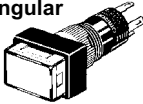
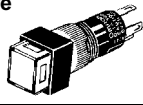
■ List of Models

Appearance	Model
 Rectangular	A3DJ
 Square	A3DA
 Round	A3DT

■ Ordering as a Set

The model numbers used to order sets of Units are given in the following table. One set comprises the Pushbutton (LED lamp built-in), and Switch.

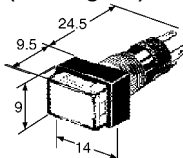
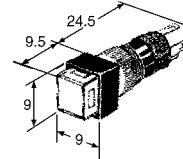
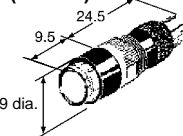
Appearance	Degree of protection	Operation	Model number	Color symbol for Pushbutton
A3DJ (Rectangular) 	IP40	Momentary	A3DJ-90A1-00E□	R, Y, G, W
		Alternate	A3DJ-90B1-00E□	
A3DA (Square) 		Momentary	A3DA-90A1-00E□	
		Alternate	A3DA-90B1-00E□	
A3DT (Round) 		Momentary	A3DT-90A1-00E□	
		Alternate	A3DT-90B1-00E□	



- Note:**
1. Enter the desired color symbol for the Pushbutton in □.
 2. All the above are solder-terminal, microload, SPST-NO, LED lamp-lighted models.

■ Ordering Individually

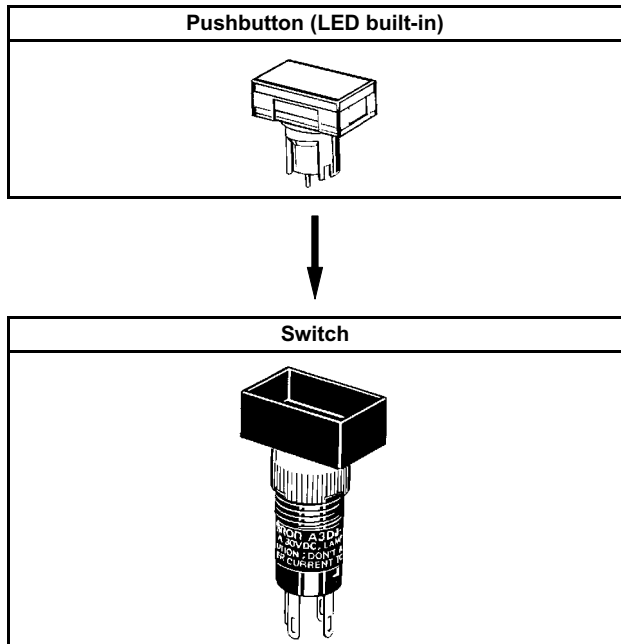
Pushbuttons and Switches can be ordered separately. Combinations that are not available as sets can be created using individual Units. Also, store the parts as spares for maintenance and repairs.





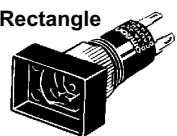
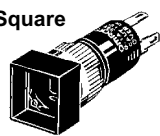
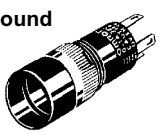

Pushbutton (All Lighted with LED Built-in)

Appearance	Rectangular	Square	Round
Color			
Red	A3DJ-500R	A3DA-500R	A3DT-500R
Yellow	A3DJ-500Y	A3DA-500Y	A3DT-500Y
Green	A3DJ-500GY	A3DA-500GY	A3DT-500GY
White	A3DJ-500W	A3DA-500W	A3DT-500W

Switch

Contact type	Operating action	Terminal type	Sealing Appearance		
			Rectangle	Square	Round
					
SPST-NO	Momentary	Solder terminals	A3DJ-7111	A3DA-7111	A3DT-7111
	Alternative	Solder terminals	A3DJ-7121	A3DA-7121	A3DT-7121

■ Accessories (Order Separately)

Name	Appearance	Classification	Model	Application precautions
Socket		Wire-wrap terminal	A3D-4101	Cannot be used together with Insulation Cover.
		PCB terminal	A3D-4102	
		Solder terminal	A3D-4103	
Insulation Cover		---	A3D-3002	Cannot be used together with the Socket.
Tightening Tool		---	A3D-3004	Do not tighten to a torque exceeding 0.29 N·m.
Legend Plate		Rectangular	A3DJ-5201	One milky-white Legend Plate is included with standard products.
		Square	A3DA-5201	
		Round	A3DT-5201	

Specifications

■ Ratings

Contact Rating: 30 VDC, 0.1 A (Minimum Applicable Load: 5 VDC, 1 mA)

The above ratings conform to JIS C4505, for testing under the following conditions.

Built-in LED Lamp

1. Load: Resistive load
2. Mounting conditions: No vibration or shock
3. Ambient temperature: $20 \pm 2^\circ\text{C}$.
4. Operating frequency: 20 times/min.

Item		Color		
		Red	Yellow (White) (See note 4.)	Green
Forward voltage, V_F	Reference value (See note 3.)	1.7 V	2.2 V	2.1 V
	Maximum value	2.0 V	2.5 V	2.5 V
Forward current, I_F	Reference value	20 mA	20 mA	20 mA
	Absolute maximum value	50 mA	50 mA	50 mA
Permissible dissipation, PD	Absolute maximum value	100 mW	125 mW	122 mW
Reverse voltage, V_R	Absolute maximum value	4 V	4 V	4 V

- Note:**
1. The above ratings are for an ambient temperature of 25°C .
 2. The built-in LED lamp has no limiting resistor and so it is necessary to connect an external resistor within the range shown in the above table. (For details of calculation formulas, refer to page 28.)
 3. Refer to the characteristic graphs of $V_F - I_F$ on page 24.
 4. The same LED lamp is used for both yellow illumination and white illumination and so the ratings are the same.

■ Characteristics

Operating frequency	Mechanical: 120 operations/minute max. (See note 1.) Electrical: 20 operations/minute max.
Insulation resistance	100 M Ω min. (at 500 VDC)
Dielectric strength	1,000 VAC, 50/60 Hz for 1 minute between terminals of same polarity
	2,000 VAC, 50/60 Hz for 1 minute between terminals of different polarity, and between each terminal and ground
	1,000 VAC, 50/60 Hz for 1 minute between lamp terminals (See note 2.)
Vibration resistance	Malfuction: 10 to 55 Hz, 1.5 mm double amplitude (See note 3.)
Shock resistance	Destruction: 500 m/s ² Malfuction: 150 m/s ² (See note 3.)
Life expectancy	Mechanical: Momentary operation models: 1,000,000 operations min. Alternate operation models: 100,000 operations min. (One operation consists of set and reset operations.)
	Electrical: 100,000 operations min.
Weight	Approx. 3 g
Ambient operating temperature	-10°C to 55°C (with no icing or condensation)
Ambient operating humidity	35% to 85%
Ambient storage temperature	-25°C to 65°C
Degree of protection	IP40
Electric shock protection class	Class II
PTI (proof tracking index)	175
Pollution degree	3 (IEC947-5-1)

- Note:**
1. With alternate operation models, 60 operations/minute max. One operation cycle consists of set and reset operations.
 2. The figure for dielectric strength between lamp terminals is for when the LED lamp is not mounted.
 3. "Malfuction" in the above table indicates malfuctions of less than 1 ms.

■ Operating Characteristics

OF max.	2.45 N
RF min.	0.196 N
TT	Approx. 3.5 mm
LTA min. (See note.)	0.5 mm
PT max.	2.5 mm

Note: The figure for LTA in the table applies only to models with alternate operation.

■ Contact Form

Contact name	Contact form
SPST-NO	COM  NO

Engineering Data

■ LED Characteristics

Ta: Ambient Temperature

V_F – I_F Characteristic for Red LED

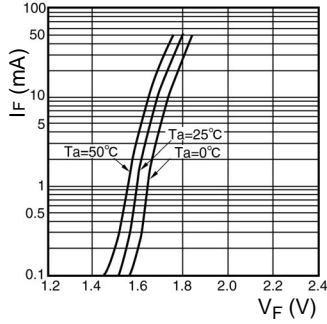

V_F – I_F Characteristic for Yellow or White LED

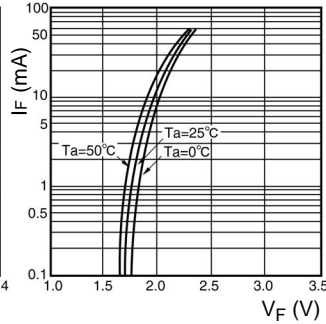

V_F – I_F Characteristic for Green LED

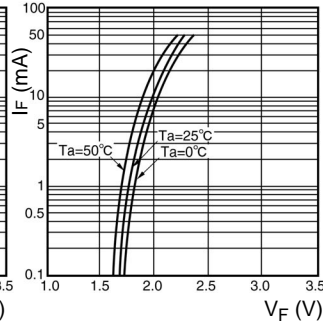

Forward Current Reduction Curve

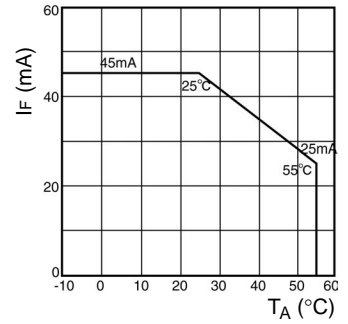

Nomenclature

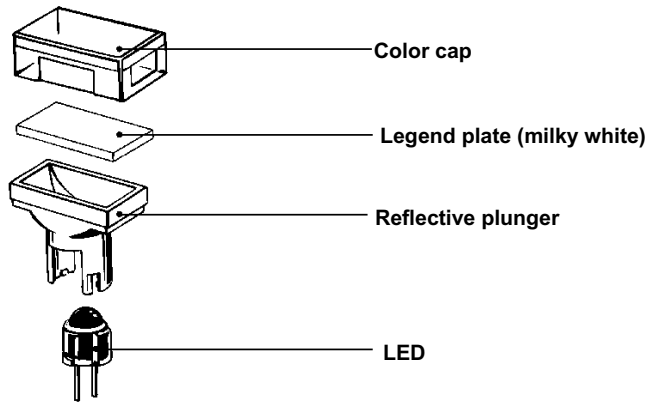

Pushbutton

Shape of Pushbutton

Rectangular (A3DJ)

Square (A3DA)

Round (A3DT)

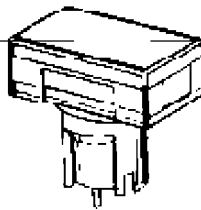

**Color of Pushbutton
(All models LED-lighted)**

Red, yellow, green, white

Note: The LED lamp is built into the Pushbutton.

Switch

Switch Specifications

Microload

0.1 A at 30 VDC

Minimum applicable load: 1 mA at 5 VDC

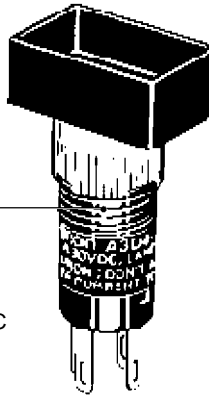

Note: The A3DJ model is shown here as a representative example.

Dimensions

Note: All units are in millimeters unless otherwise indicated.

Rectangular Models (A3DJ)

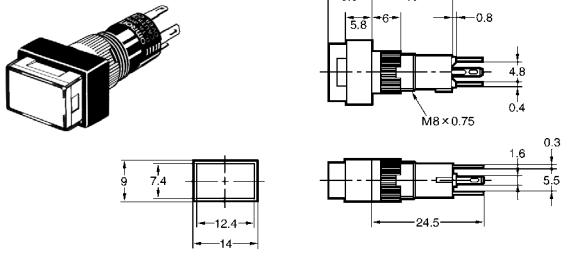

Square Models (A3DA)

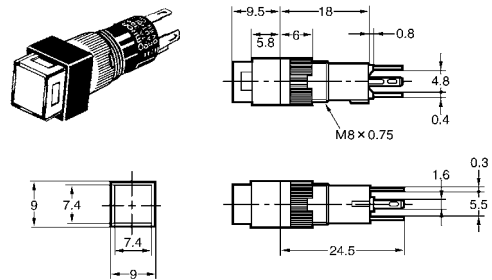

Round Models (A3DT)

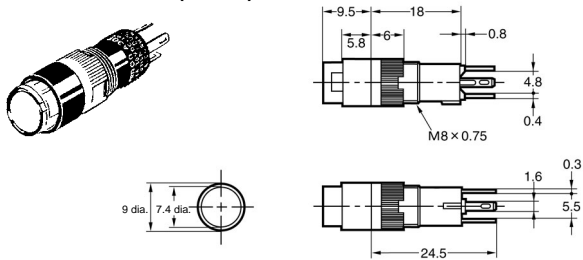

■ Terminals

Solder Terminals of SPST-NO Lighted Models

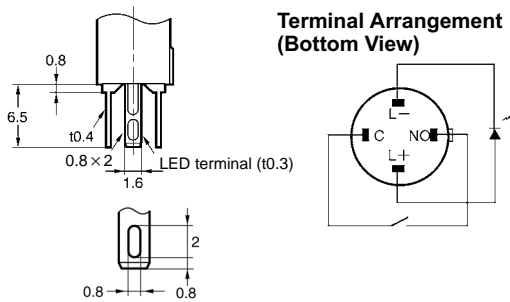

■ Panel Cutouts (Top View)

Rectangular models (A3DJ)	Square models (A3DA) and round models (A3DT)
<p>Note: Recommended panel thickness: 1.0 to 3.2 mm.</p>	<p>Note: Recommended panel thickness: 1.0 to 3.2 mm.</p>

■ Accessory Mounting Dimensions

Socket Mounting Dimensions

Wire-wrap Terminal A3D-4101

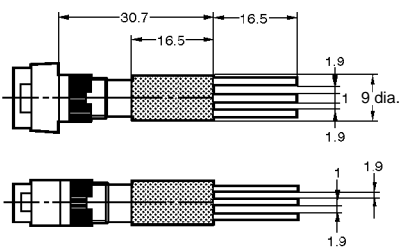

PCB Terminal A3D-4102

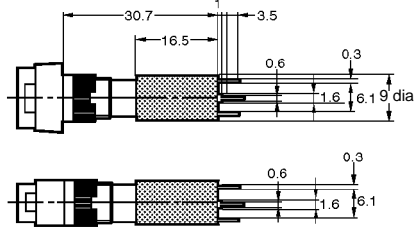

Solder Terminal A3D-4103

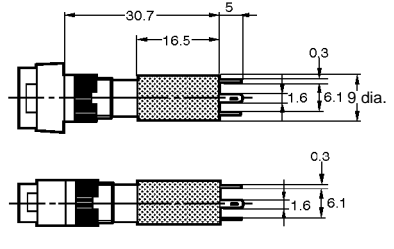

PCB Cutout (bottom view)

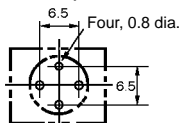

Insulation Cover Mounting Dimensions A3D-3002

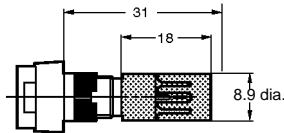

- Note:**
1. The diagram above shows the rectangular model as a representative example.
 2. Unless specified, there is a tolerance of ± 0.4 mm for dimensions.

Legend Plate Mounting Dimensions

Rectangular A3DJ-5201

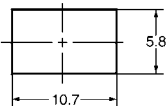

Square A3DA-5201

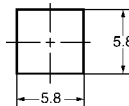

Round A3DT-5201

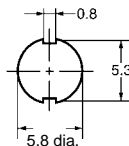

- Note:**
1. The thickness is 0.8 mm.
 2. Since the legend plate is made of polycarbonate, use alcohol-based paints such as melanin, phthalic acid, or acryl paint when marking the legend.

Installation

Mounting and Replacing the Pushbutton

Mounting Direction for the Pushbutton and Switch

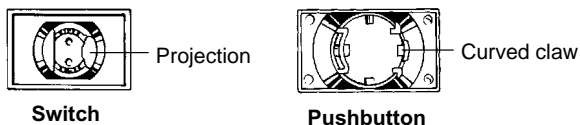

Align the curved claw on the outside of the protruding part of the Pushbutton with the projection on the upper part of the Switch and insert.

Apply a pressure between 9.8 and 24.5 N.

Note: If the terminals of the LED lamp become bent, it may be impossible to fit them into the LED lamp terminal holes. Ensure that the terminals are straight when they are inserted. Be sure to insert the lamp terminals for round models with the correct orientation. Inserting the terminals with the reverse orientation will result in damage.

Removing the Pushbutton

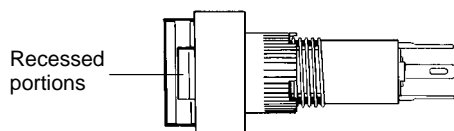

Hold the recessed portions on the cap of the Pushbutton and pull.

Note: Do not use tools such as pliers to remove the Pushbutton as this may damage the cap.

Panel Mounting

Using the Mounting Nut

Insert the Switch from the front of the panel. Mount the mounting nut from the terminal end of the Switch and tighten it.

Tighten the nut to a torque 0.20 to 0.39 N·m.

- After securing the Switch to the panel using the mounting nut, pass the lead wires through the holes in the Insulation Cover before performing wiring. Hold the Insulation Cover so that the cylindrical hole is facing the Switch, and insert the lead wires from the end with the barriers.
- After wiring is completed, mount the Insulation Cover by pushing it into the Switch.

If soldering is used, mount the mounting nut first. Lead wires and mounds of solder may make it impossible to mount the nut after soldering.

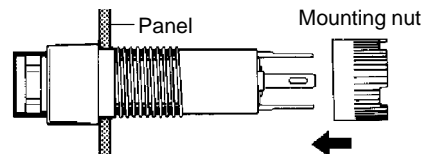

Socket Mounting

After securing the Switch to the panel using the mounting nut, insert the Socket into the Switch.

When inserting the Socket, align the positioning groove of the Socket with the projecting part of the Switch.

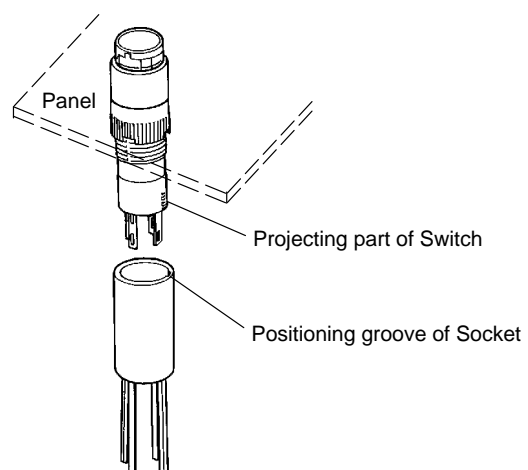

Precautions

Refer to the *Common Precautions* for Pushbutton Switches on page 14.

Correct Use

Mounting

Always make sure that the power is turned OFF before mounting, removing, or wiring the Switch, or performing maintenance.

Do not tighten the mounting ring excessively using pliers or a similar tool. Excessive tightening may damage the mounting ring. (Tightening torque: 0.20 to 0.29 N·m)

Wiring

When wiring, use wires of a size appropriate for the applied voltage and carry current. Perform soldering correctly under the conditions given below. Using the Switch with the wires soldered incorrectly may cause the terminals to become abnormally hot and cause a fire.

1. Hand soldering: At 30 W within 5 seconds.
2. Dip soldering: At 240°C within 3 seconds.

Wait for one minute after soldering before exerting any external force on the solder.

Use a non-corrosive rosin liquid for the flux.

Perform wiring so that the wire sheaths do not come into contact with the Switch. If this is unavoidable, use wires that can withstand temperatures of 100°C min.

After wiring to the Switch has been completed, ensure an appropriate insulation distance.

LED

The polarity of the LED is indicated on the back of the Switch. Wire the LED correctly according to the polarity.

The built-in LED does not have a limiting resistor. Connect a limiting resistor.

Make sure that the limiting resistor satisfies the characteristics of the built-in LED. The forward current of the built-in LED must be 8 mA minimum.

The resistance can be calculated by using the following expression.

$$R = (E - V_F) / I_F (\Omega)$$

E: Operating voltage (V)

V_F : LED forward voltage (V)

I_F : LED forward current (A)

Recommended Values for Limiting Resistance

Voltage	Red	Yellow (White)	Green
5 VDC	165 Ω	140 Ω	145 Ω
12 VDC	515 Ω	490 Ω	495 Ω
24 VDC	1,100 Ω	1,090 Ω	1,095 Ω

Note: The above values are calculated values that can be used as reference.

Calculation Example for Limiting Resistance

Conditions: Red LED with an I_F of 20 mA at 24 V and a T_a of 25°C. From the red LED characteristic given previously, V_F will be 1.7 V when I_F is 20 mA. Therefore, $R = (24 \text{ V} - 1.7 \text{ V}) / 0.02 \text{ A} = 1,100 \Omega$. Thus the recommended resistance is 1.1 k Ω at 1 W ($2 \times I_F^2 R$). (see note)

Note: A factor of 2 is applied because the permissible wattage of the resistor must be twice as large as the required wattage.

Operating Environment

Ensure that dust, metal powder, or oil do not enter the interior of the Switch.

Using Microloads

Using a standard load switch for opening and closing a microload circuit may cause wear on the contacts. Use the switch within the operating range. (Refer to the diagram below.) Even when using microload models within the operating range shown below, if inrush current occurs when the contact is opened or closed, it may cause the contact surface to become rough, and so decrease life expectancy. Therefore, insert a contact protection circuit where necessary. The minimum applicable load is the N-level reference value. This value indicates the malfunction reference level for the reliability level of 60% ($\lambda 60$) (conforming to JIS C5003). The equation, $\lambda 60 = 0.5 \times 10^{-4}$ times indicates that the estimated malfunction rate is less than 1/2,000,000 with a reliability level of 60%.

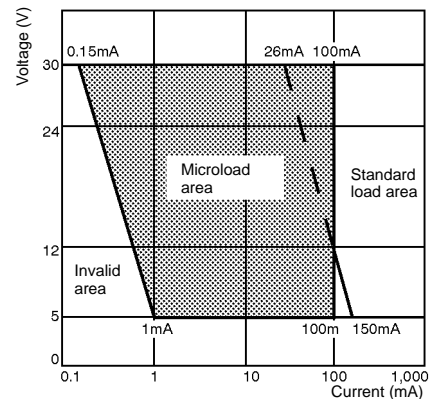

ALL DIMENSIONS SHOWN ARE IN MILLIMETERS.

To convert millimeters into inches, multiply by 0.03937. To convert grams into ounces, multiply by 0.03527.

Cylindrical 8-dia. Indicator

- Same basic design as the A3D Pushbutton Switch.
- Good illumination with even surface brightness.
- Cylindrical body means panel cutouts can be made easily.



Ordering Information

■ Model Number Legend:

The model numbers used to order sets of Units are illustrated below. One set comprises the Display (LED lamp built-in) and Socket Unit.

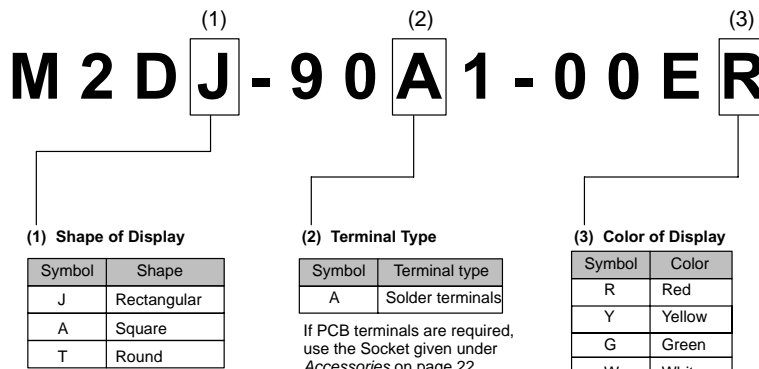

All models are illumination-only. Colored-illumination models are not available.

An external resistor is required. (Refer to page 28.)

■ List of Models

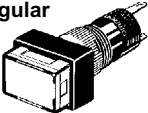
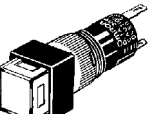
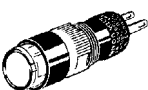
Appearance	Model
 Rectangular	M2DJ
 Square	M2DA
 Round	M2DT

■ Ordering as a Set

The model numbers used to order sets of Units are given in the following table. One set comprises the Display (LED lamp built-in), and Socket Unit.

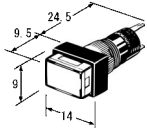
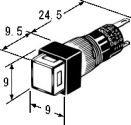
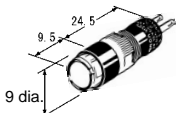
Appearance	Degree of protection	Model number	Color symbol for Display
Rectangular 	IP40	M2DJ-90A1-00E□	R, Y, G, W
Square 		M2DA-90A1-00E□	
Round 		M2DT-90A1-00E□	

- Note:**
1. Enter the desired color symbol for the Display in □: R (red), Y (yellow), G (green), or W (white)
 2. Degree of protection: IP40

■ Ordering Individually

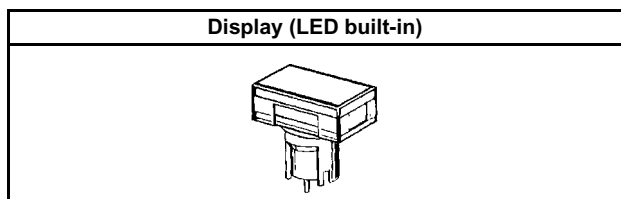

Displays and Socket Units can be ordered separately. Combinations that are not available as sets can be created using individual Units. Also, store the parts as spares for maintenance and repairs.

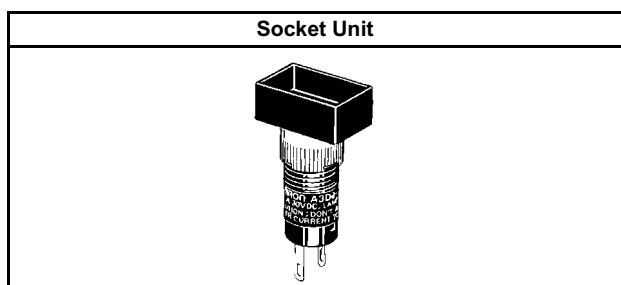

Note: Degree of protection: IP40



■ Display (All Lighted with LED Built-in)

Appearance	Rectangular	Square	Round
Color			
Red	M2DJ-500R	M2DA-500R	M2DT-500R
Yellow	M2DJ-500Y	M2DA-500Y	M2DT-500Y
Green	M2DJ-500GY	M2DA-500GY	M2DT-500GY
White	M2DJ-500W	M2DA-500W	M2DT-500W

Socket Unit

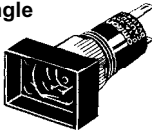
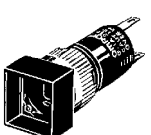
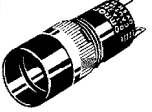
Sealing Appearance	IP40		
	Rectangle	Square	Round
Terminal type			
Solder terminals	M2DJ-7001	M2DA-7001	M2DT-7001

■ Accessories

The accessories for the A3D Lighted Pushbutton Switch can also be used with the M2D. Refer to page 22.

Specifications

■ Ratings

Built-in LED Lamp

Item		Color		
		Red	Yellow (White) (See note 4.)	Green
Forward voltage, V_F	Reference value (See note 3.)	1.7 V	2.2 V	2.1 V
	Maximum value	2.0 V	2.5 V	2.5 V
Forward current, I_F	Reference value	20 mA	20 mA	20 mA
	Absolute maximum value	50 mA	50 mA	50 mA
Permissible dissipation, PD	Absolute maximum value	100 mW	125 mW	122 mW
Reverse voltage, V_R	Absolute maximum value	4 V	4 V	4 V

- Note:**
1. The above ratings are for an ambient temperature of 25°C.
 2. The built-in LED lamp has no limiting resistor and so it is necessary to connect an external resistor within the range shown in the above table. (For details of calculation formulas, refer to page 28.)
 3. Refer to the characteristic graph of $V_F - I_F$ on page 24.
 4. The same LED lamp is used for both yellow illumination and white illumination and so the ratings are the same.

■ Characteristics

Ambient operating temperature	-10°C to 55°C (with no icing or condensation)
Ambient operating humidity	35% to 85%
Ambient storage temperature	-25°C to 65°C

Nomenclature

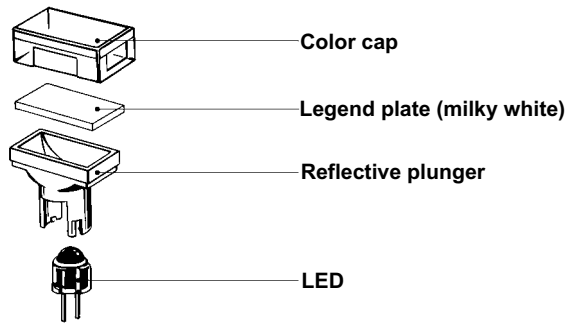

Display

Shape of Display

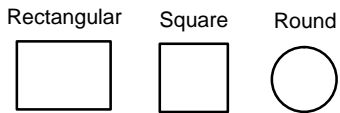

Color of Display

(All models LED-lighted)

Red, yellow, green, white

Note: The LED lamp is built into the Display.

Socket Unit

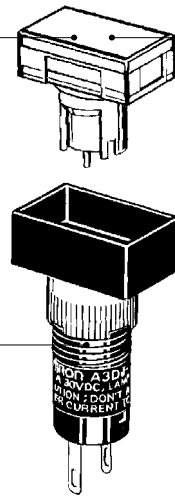

Note: The M2DJ model is shown here as a representative example.

Dimensions

Note: All units are in millimeters unless otherwise indicated.

Rectangular Models
(M2DJ-90A1-00E□)

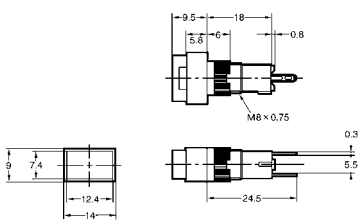

Square Models
(M2DA-90A1-00E□)

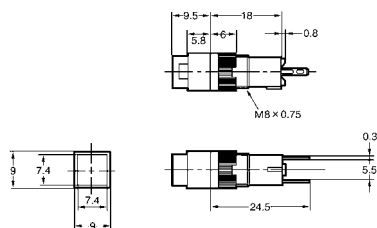

Square Models
(M2DT-90A1-00E□)

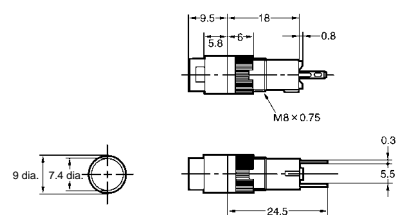

Note: Unless specified, there is a tolerance of ± 0.4 mm for dimensions.

■ Terminals

Solder Terminals

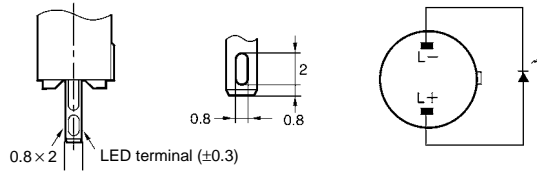

■ Panel Cutouts (Top View)

Rectangular models (M2DJ)	Square models (M2DA) and round models (M2DT)
<p>Note: Recommended panel thickness: 1.0 to 3.2 mm.</p>	<p>Note: Recommended panel thickness: 1.0 to 3.2 mm.</p>

Note: If the panel is to be finished (e.g., coated), make sure that the panel meets the specified dimensions after the coating.

Precautions

■ Correct Use

Refer to the *Common Precautions* for Pushbutton Switches on page 14.

Refer to *Correct Use* for A3D on page 28.

ALL DIMENSIONS SHOWN ARE IN MILLIMETERS.

To convert millimeters into inches, multiply by 0.03937. To convert grams into ounces, multiply by 0.03527.

Lighted Pushbutton Switch

A3C

Cylindrical 12-dia. Series with Superb Operability, High Visibility, and Compact Housing

- Three models of Pushbuttons (round, square, and rectangular), two types of light-emitting elements (LED lamp and incandescent lamp), and two types of Switches (switching standard loads and microloads) available.
- Models that can be used as an indicator also available.
- Requires only 20 mm mounting depth
- Efficiency in wiring improved by terminals arranged on the same surface.
- All LED lamps, incandescent lamps, caps, and legends replaceable without tools.
- UL (E41515) and CSA (LR45258) approved.



Ordering Information

■ Model Number Legend

When placing your order, specify the individual component part model numbers of the Pushbutton, Lamp (lighted models only), and Switch, as listed in the ordering tables below.

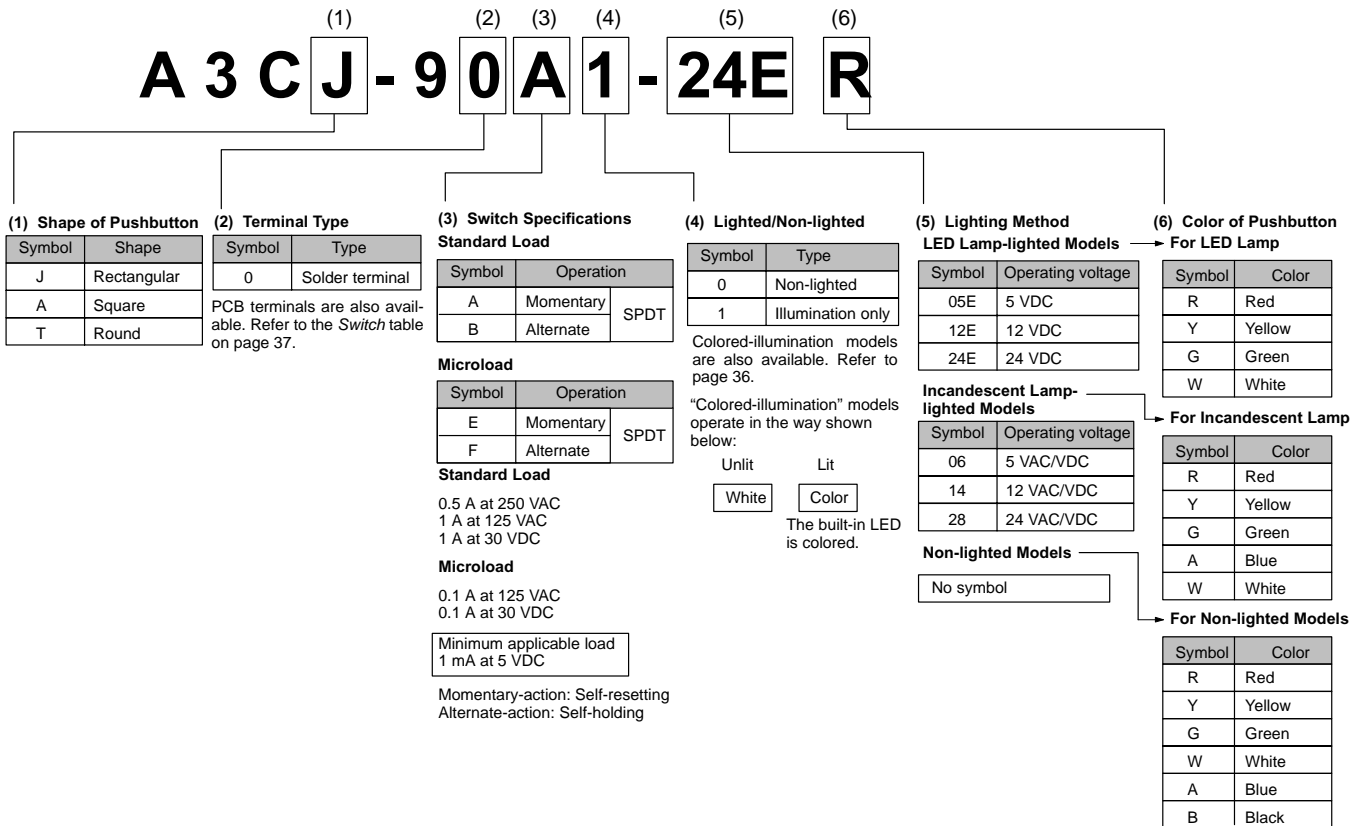

■ Ordering as a Set

The model numbers used to order sets of Units are given in the following tables. One set comprises the Pushbutton, Lamp (lighted models only), and Switch.

Rectangular Models

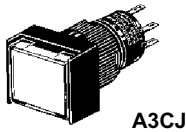

Square Models

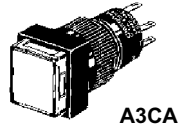

Round Models

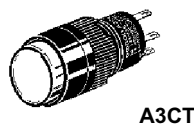

Lighted Pushbutton Switches (SPST-NO+SPST-NC Solder Terminals)

Shape	Contact type Operation Lighting	Standard load		Microload	Pushbutton color symbol
		Momentary operation (Self-resetting)	Alternate operation (Self-holding)	Momentary operation (Self-resetting)	
Rectangular (A3CJ)	LED lamp	A3CJ-90A1-05E□	A3CJ-90B1-05E□	A3CJ-90E1-05E□	R: red Y: yellow G: green W: white
		A3CJ-90A1-12E□	A3CJ-90B1-12E□	A3CJ-90E1-12E□	
		A3CJ-90A1-24E□	A3CJ-90B1-24E□	A3CJ-90E1-24E□	
	Incandescent lamp	A3CJ-90A1-06□	---		R: red Y: yellow G: green W: white A: blue B: black (See note 3.)
		A3CJ-90A1-14□			
		A3CJ-90A1-28□			
	Non-lighted	A3CJ-90A0-□	A3CJ-90B0-□	A3CJ-90E0-□	
Square (A3CA)	LED lamp	A3CA-90A1-05E□	A3CA-90B1-05E□	A3CA-90E1-05E□	R: red Y: yellow G: green W: white
		A3CA-90A1-12E□	A3CA-90B1-12E□	A3CA-90E1-12E□	
		A3CA-90A1-24E□	A3CA-90B1-24E□	A3CA-90E1-24E□	
	Incandescent lamp	A3CA-90A1-06□	---		R: red Y: yellow G: green W: white A: blue B: black (See note 3.)
		A3CA-90A1-14□			
		A3CA-90A1-28□			
	Non-lighted	A3CA-90A0-□	A3CA-90B0-□	A3CA-90E0-□	
Round (A3CT)	LED lamp	A3CT-90A1-05E□	A3CT-90B1-05E□	A3CT-90E1-05E□	R: red Y: yellow G: green W: white
		A3CT-90A1-12E□	A3CT-90B1-12E□	A3CT-90E1-12E□	
		A3CT-90A1-24E□	A3CT-90B1-24E□	A3CT-90E1-24E□	
	Incandescent lamp	A3CT-90A1-06□	---		R: red Y: yellow G: green W: white A: blue B: black (See note 3.)
		A3CT-90A1-14□			
		A3CT-90A1-28□			
	Non-lighted	A3CT-90A0-□	A3CT-90B0-□	A3CT-90E0-□	

- Note:**
1. Enter the desired color symbol for the Pushbutton in the □ at the end of the model number.
 2. There are also alternate-operation models that can be used for microloads. Refer to the *Switch* table on page 37.
 3. Black ("B") Pushbuttons are only available for non-lighted models.

■ Illumination-only and Colored-illumination LED Models

“Illumination only” describes LED models for which the screen color is the same whether the LED is lit or not. The screen simply becomes brighter when the LED lights.

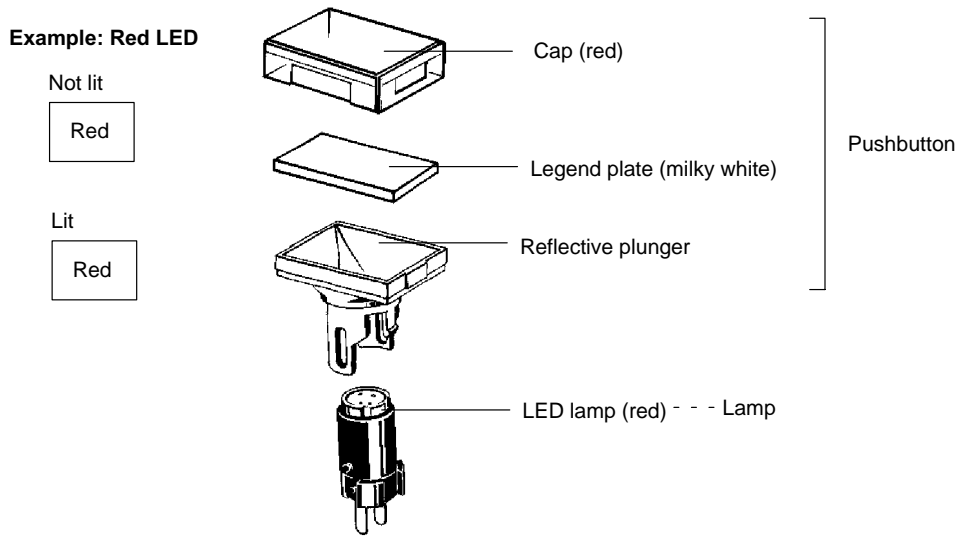

“Colored illumination” describes LED models for which the screen color is white when the LED is not lit and changes to the color of the LED lamp when the LED is lit.

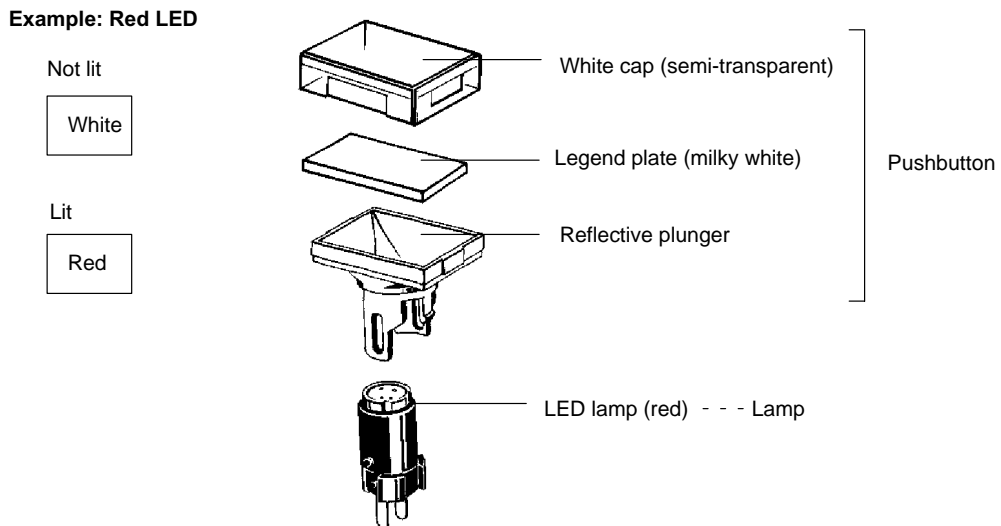

Ordering: With colored-illumination models, order the Pushbutton, Lamp, and Switch as shown in the following table.



Illuminated color	Pushbutton	Lamp (LED)	Switch
Red	IP40 A3C□-500W	A16-□DR	Refer to the following information. Order the Switch that is appropriate for the Pushbutton.
Yellow	Enter one of the following symbols in □. J: Rectangular A: Square T: Round	A16-□DY	
Green		A16-□DG	
		Enter one of the following symbols in □. 5: 5 VDC 12: 12 VDC 24: 24 VDC	

Ordering Individually

Pushbuttons, Lamps, and Switches can be ordered separately. Combinations that are not available as sets can be created using individual Units. Also, store the parts as spares for maintenance and repairs.

Pushbuttons

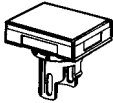
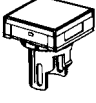
LED Lamp

Button color	Rectangular	Square	Round
			
Red	A3CJ-500R	A3CA-500R	A3CT-500R
Yellow	A3CJ-500Y	A3CA-500Y	A3CT-500Y
Green	A3CJ-500GY	A3CA-500GY	A3CT-500GY
White	A3CJ-500W	A3CA-500W	A3CT-500W

Note: The red, yellow, and white Pushbuttons listed above can be used with either LED lamp-lighted models or incandescent lamp-lighted models.

Non-lighted Models

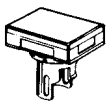
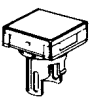
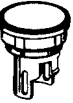
Button color	Rectangular	Square	Round
			
Red	A3CJ-500R	A3CA-500R	A3CT-500R
Yellow	A3CJ-500Y	A3CA-500Y	A3CT-500Y
Green	A3CJ-500G	A3CA-500G	A3CT-500G
White	A3CJ-500W	A3CA-500W	A3CT-500W
Blue	A3CJ-500A	A3CA-500A	A3CT-500A
Black	A3CJ-501B	A3CA-501B	A3CT-501B

Incandescent Lamp

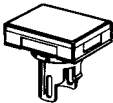
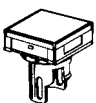
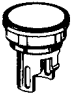
Button color	Rectangular	Square	Round
			
Red	A3CJ-500R	A3CA-500R	A3CT-500R
Yellow	A3CJ-500Y	A3CA-500Y	A3CT-500Y
Green	A3CJ-500G	A3CA-500G	A3CT-500G
White	A3CJ-500W	A3CA-500W	A3CT-500W
Blue	A3CJ-500A	A3CA-500A	A3CT-500A

Lamps



LED Lamp

Color	Rated voltage		
	5 VDC	12 VDC	24 VDC
Red	A16-5DR	A16-12DR	A16-24DR
Yellow	A16-5DY	A16-12DY	A16-24DY
Green	A16-5DG	A16-12DG	A16-24DG
White	A16-5DW	A16-12DW	A16-24DW









Incandescent Lamp

Rated voltage	6 VAC/VDC	14 VAC/VDC	28 VAC/VDC
Model	A16-5	A16-12	A16-24

Switches

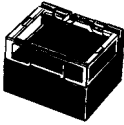
Configuration	Contact	Switch action	Terminal	Degree of protection: IP40		
				Rectangular	Square	Round
Standard	SPST-NO+ SPST-NC	Momentary	Solder			
		Alternate		A3CJ-7011	A3CA-7011	A3CT-7011
Microload		Momentary		A3CJ-7021	A3CA-7021	A3CT-7021
		Alternate		A3CJ-7111	A3CA-7111	A3CT-7111
				A3CJ-7121	A3CA-7121	A3CT-7121

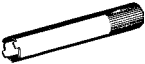
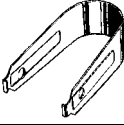
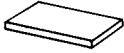
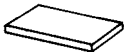
Accessories (Order Separately)

Name	Appearance	Classification	Model	Remarks
Socket		Wire-wrap terminal	A3C-4101	Cannot be used with Insulation Cover.
		PCB terminal	A3C-4102	
		Solder terminal	A3C-4103	
Insulation Cover		---	A3C-3002	Cannot be used with Socket.
Switch Guard		For rectangular models	A3CJ-5050	Cannot be used with Dust Cover.
		For square, round models	A3CA-5050	
Dust Cover		For rectangular models	A3CJ-5060	Cannot be used with Switch Guard.
Tightening Tool		---	A3C-3004	The tightening torque is 0.20 to 0.39 N·m.
Extractor		---	A3PJ-5080	---
Legend Plate		For rectangular models	A3CJ-5201	One Legend Plate is supplied per standard Switch.
		For square models	A3CA-5201	
		For round models	A3CT-5201	

Specifications

■ Contact Ratings

Model	Item	
	AC resistive load	DC resistive load
Standard load	0.5 A at 250 VAC 1 A at 125 VAC	1 A at 30 VDC
Microload (See note 1.)	0.1 A at 125 VAC	0.1 A at 30 VDC

- Note:**
- The minimum permissible load is 1 mA, 5 VDC.
 - The above ratings are for testing under the following conditions:
 - Load: Resistive load
 - Mounting conditions: No vibrations or shock
 - Temperature: 20°C ± 2°C
 - Operation frequency: 20 operations/minute

■ LED Lamp Ratings

Rated voltage	Rated current	Operating voltage	Internal limiting resistance
5 VDC	30 mA	5 VDC±5%	33 Ω
12 VDC	15 mA	12 VDC±5%	270 Ω
24 VDC	10 mA	24 VDC±5%	1,600 Ω

■ Incandescent Lamp Ratings

Rated voltage	Rated current	Operating voltage
6 VAC/VDC	60 mA	5 VAC/VDC
14 VAC/VDC	40 mA	12 VAC/VDC
28 VAC/VDC	24 mA	24 VAC/VDC

■ Characteristics

Operating frequency	Mechanical: Momentary-action models: 120 operations/minute max. Alternate-action models: 60 operations/minute max. (See note 1.) Electrical: 20 operations/minute max.
Insulation resistance	100 MΩ min. (at 500 VDC)
Dielectric strength	1,000 VAC, 50/60 Hz for 1 minute between terminals of same polarity and between lamp terminals (See note 2.) 2,000 VAC, 50/60 Hz for 1 minute between terminals of different polarity and also between each terminal and ground
Vibration	Malfunction: 10 to 55 Hz, 1.5-mm double amplitude (No malfunctions for more than 1 s.)
Shock	Destruction: 500 m/s ² Malfunction: 150 m/s ² (No malfunctions for more than 1 s.)
Life expectancy	Mechanical: Momentary-action models: 1,000,000 operations min. Alternate-action models: 100,000 operations min. (See note 1.) Electrical: 100,000 operations min.
Weight	Approx. 5 g (See note 3.)
Ambient operating temperature	-10°C to 55°C (with no icing or condensation)
Ambient operating humidity	35% to 85%
Ambient storage temperature	-25°C to 65°C
Degree of protection	IP40
Electric shock protection class	Class II
PTI (proof tracking index)	175
Pollution degree	3 (IEC947-5-1)

- Note:**
1. With alternate-operation models, one operation cycle consists of set and reset operations.
 2. The figure given above for the dielectric strength between lamp terminals is for when there is no LED lamp or incandescent lamp mounted.
 3. The weight indicated here applies to the lighted models (SPST-NO+SPST-NC).

■ Operating Characteristics

OF max.	2.45 N
RF min.	0.29 N
TT	Approx. 3.5 mm
LTA min. (See note.)	0.5 mm
PT max.	2.5 mm

Note: The value for LTA min. applies to alternate-operation models only.

■ Approved by Standards

UL (File No. E41515)
CSA (File No. LR45258-31)

Rating Standard

1 A at 125 VAC
0.5 A at 250 VAC
1 A at 30 VDC

Microload

0.1 A at 125 VAC
0.1 A at 30 VDC

■ Contact Form

Contact name	Contact form
SPDT	

Nomenclature

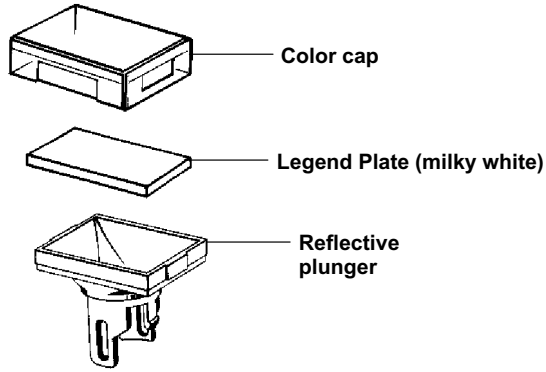

Pushbutton

Shape of Pushbutton

Rectangular (A3CJ)

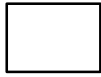

Square (A3CA)



Round (A3CT)

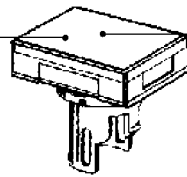

Color of Pushbutton

- LED lamp-lighted Models:
Red, yellow, green, white
- Incandescent lamp-lighted Models:
Red, yellow, green, white, blue
- Non-lighted Models:
Red, yellow, green, white, blue, black



Lamp
LED Lamp



Incandescent Lamp

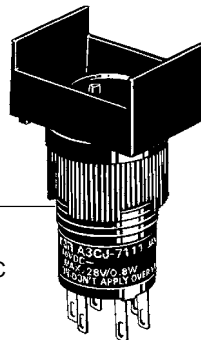

Switch

- Standard load:
0.5 A at 250 VAC
1 A at 125 VAC
1 A at 30 VDC
- Microload:
0.1 A at 125 VAC,
0.1 A at 30 VDC
Minimum applicable load: 1 mA at 5 VDC

Note: The A3CJ model is shown here as a representative example.

Dimensions

The following dimensions apply to the Switch with SPST-NO+SPST-NC contact configuration, with solder terminals.

Rectangular Models A3CJ

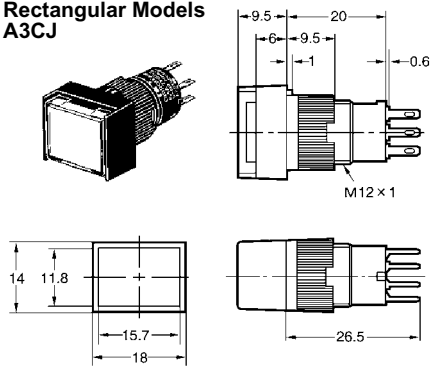

Square Models A3CA

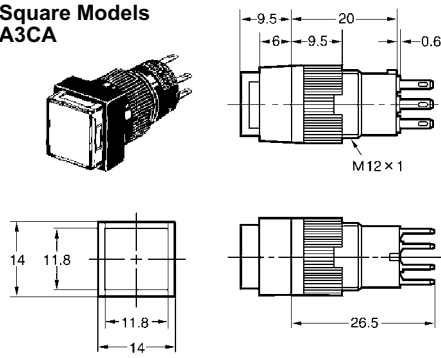

Round Models A3CT

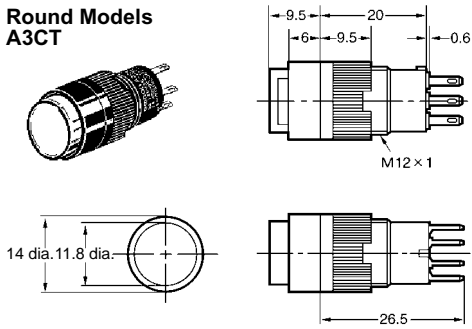

■ Accessory Mounting Dimensions Dimensions with Socket Mounted

The diagrams below show the external dimensions for rectangular models as representative models.

**Wire-wrap Terminal
A3C-4101**

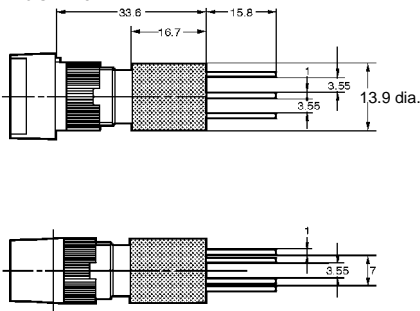

**PCB Terminal
A3C-4102**

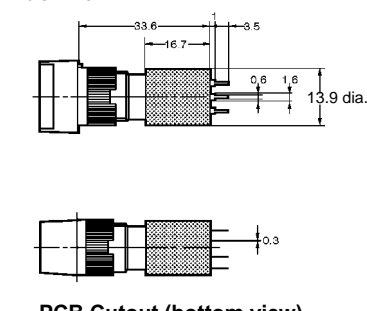

**Solder Terminal
A3C-4103**

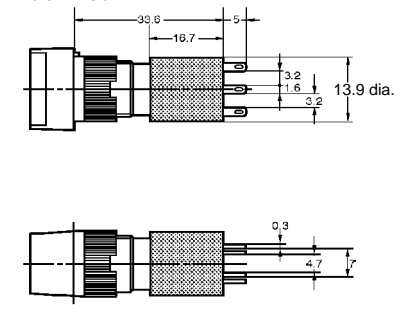

PCB Cutout (bottom view)

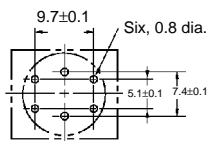

Terminal Hole Dimensions

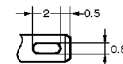

Switch Guard

**Rectangular
A3CJ-5050**

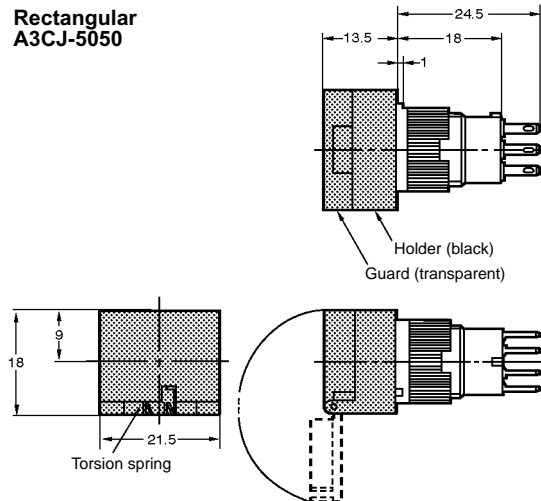

**Square/Round
A3CA-5050**

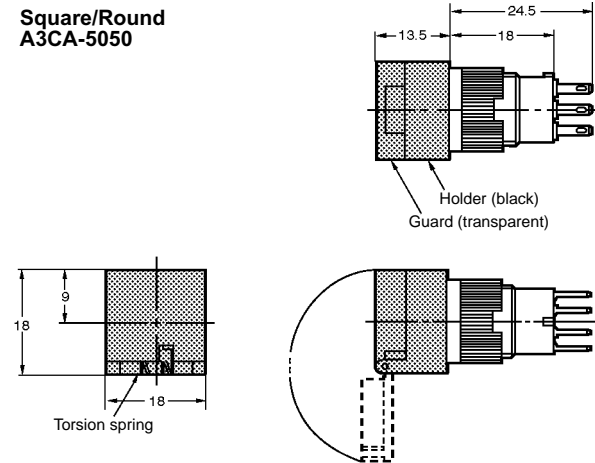

**Dust Cover
A3CJ-5060**

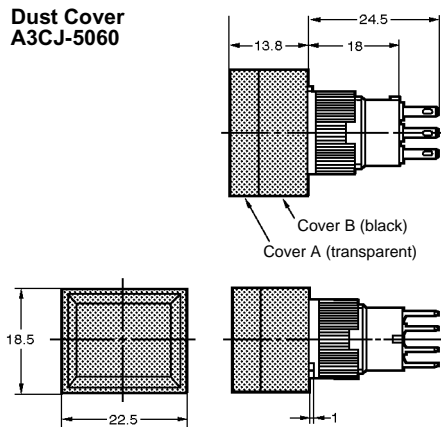

Legend Plate

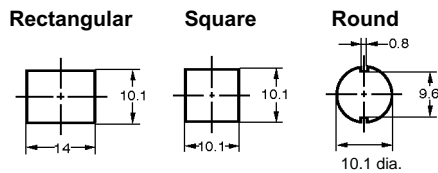

- Note:**
1. The thickness is 0.8 mm.
 2. Since the Legend Plate is made of polycarbonate, use alcohol-based paints such as melanin, phthalic acid, or acryl paint when marking the legend.

**Insulation Cover
A3C-3002**

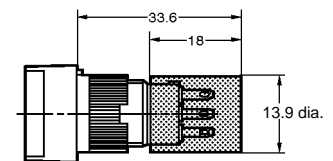

■ Panel Cutout (Top View)

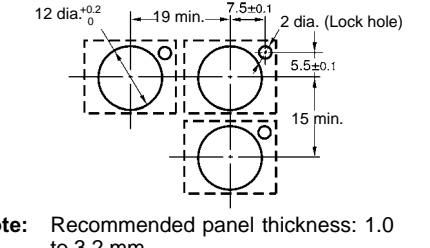
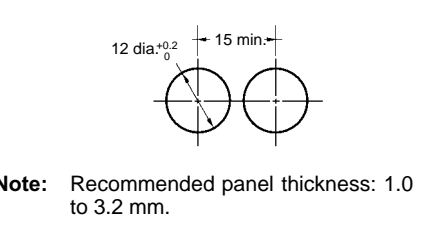
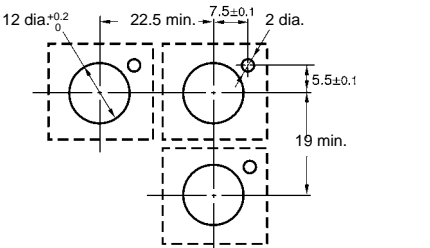
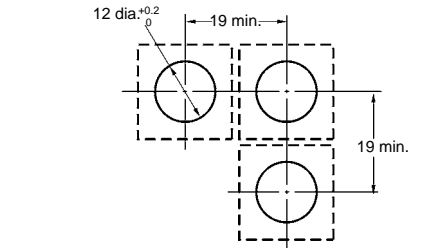
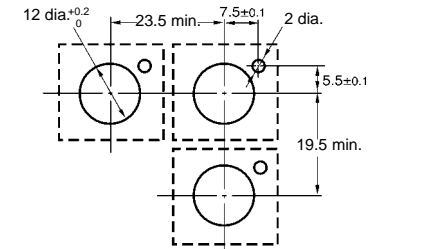
Accessories used	Rectangular/A3CJ	Square/A3CA, Round/A3CT
Switch only	 <p>Note: Recommended panel thickness: 1.0 to 3.2 mm.</p>	 <p>Note: Recommended panel thickness: 1.0 to 3.2 mm.</p>
With Switch Guard		
With Dust Cover		<p>---</p>

Note: If the panel is to be finished (e.g., coated), make sure that the panel meets the specified dimensions after the coating.

Operation

■ Terminal Connections

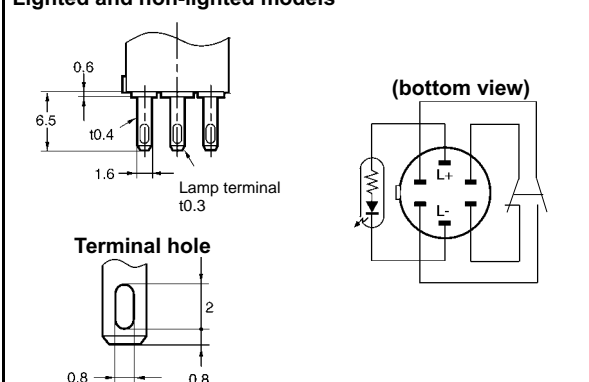
Terminal	Type
	SPST-NO+SPST-NC
Solder terminal	<p>Lighted and non-lighted models</p> 

Installation

Mounting and Replacing the Pushbutton

Mounting Direction for the Pushbutton/Display and Lamp

Lighted Pushbutton Switch

- Insert the Lamp (incandescent lamp or LED lamp) into the Pushbutton so that the lamp guide fits into the wider gap between the projections on the Pushbutton.

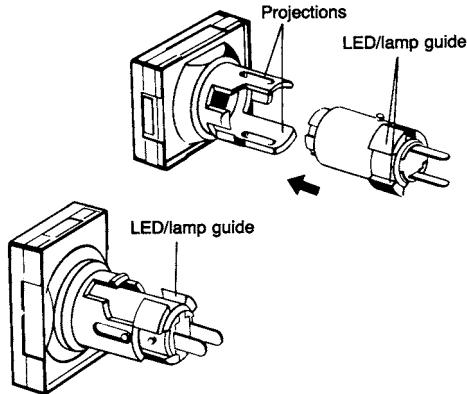

Indicator

- With Indicators, the Lamp is inserted facing the opposite direction (i.e., at 180°) to that for Lighted Pushbutton Switches.

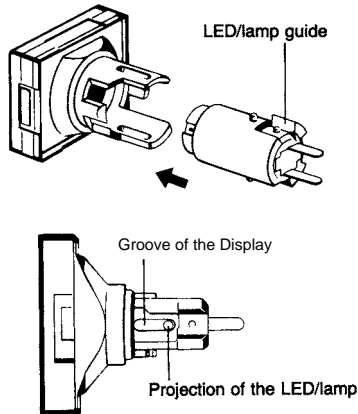

- Note:**
1. Push the projections on the Lamp into the grooves on the Pushbutton/Display.
 2. The Lamp for Lighted Pushbutton Switches moves, but the Lamp for Indicators is fixed.

Mounting Direction for the Pushbutton/Display and Switch

Insert the Pushbutton/Display into the Switch so that the lamp guide is aligned with the non-projecting part of the Switch.

Apply a pressure between 9.8 and 24.5 N.

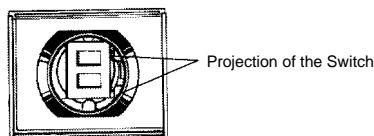

- Note:**
1. The mounting direction for Indicators is 180° to that for Lighted Pushbutton Switches. Be sure to insert the Legend Plate and other parts with the correct orientation.

2. If the terminals of the Lamp become bent, it may be impossible to fit them into the lamp terminal holes. Ensure that the terminals are straight when they are inserted.
3. Take particular care about the mounting direction with the round models (A3CT).

Removing the Pushbutton/Display

Hold the recessed portions on the cap of the Pushbutton and pull.

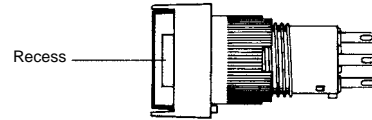

Note: Do not use tools such as pliers to remove the Pushbutton as this may damage the cap.

Panel Mounting

Insert the Switch from the front of the panel. Mount the mounting nut from the terminal end of the Switch and tighten it.

There are projections on the terminal end of the Switch which may, depending on the orientation, block the nut. In this case, turn the nut until it is possible to mount it. Tighten the nut to a torque between 0.20 and 0.39 N·m.

If soldering is used, mount the mounting nut first. Lead wires and mounds of solder may make it impossible to mount the nut after soldering.

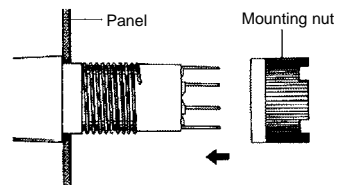

Socket Mounting

After securing the Switch to the panel using the mounting nut, insert the Socket into the Switch.

Align the positioning holes of the Socket with the projections of the Switch before inserting the Socket.

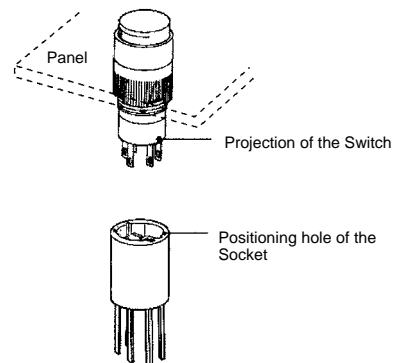

Mounting the Insulation Cover

After securing the Switch to the panel using the mounting nut, pass the lead wires through the holes in the Insulation Cover and then perform wiring. Hold the Insulation Cover so that the cylindrical hole is facing the Switch, and insert the lead wires from the end with the barriers.

After wiring is completed, mount the Insulation Cover by pushing it into the Switch.

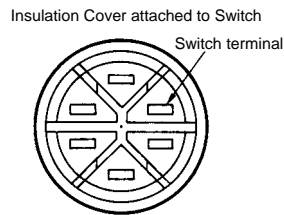

Mounting the Dust Cover

1. The Dust Cover separates into 2 parts: the cap and the mounting frame.
2. Insert the Switch into the mounting frame. (Align the lock projection with the recess on the mounting frame.)
3. Insert the Switch in the state described in step 2 into the panel. (Align the lock protrusion on the mounting frame with the hole in the panel.)
4. Mount the mounting nut from the back of the panel and tighten it.
5. Insert the cap into the mounting frame. Ensure that the entire perimeter of the cap is properly inserted into the mounting frame by pressing down on the cap from different directions.

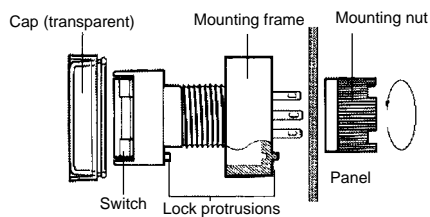

Mounting the Switch Guard

1. Insert the Switch into the Switch Guard.
2. Insert the Switch into the panel in the state described in step 1.
3. Mount the mounting nut from the back of the panel and tighten it.

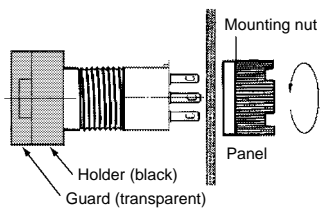

Precautions

Caution

Do not apply a voltage higher than the maximum rated operating voltage between the lamp terminals, as there is a risk that the incandescent lamp or LED lamp will be damaged, and the Pushbutton will be ejected.

When replacing the incandescent lamp, first turn OFF the power supply, and then wait 10 minutes before performing replacement, as the lamp is still hot immediately after the power is turned OFF, so there is a risk of burns.

Refer to the *Common Precautions* for Pushbutton Switches on page 14.

Correct Use

Mounting

To prevent electric shock or a fire, always make sure that the power is turned OFF before mounting, removing, or wiring the Switch, or performing maintenance.

Do not tighten the mounting ring excessively using pliers or a similar tool. Excessive tightening may damage the mounting ring. (Tightening torque: 0.20 to 0.39 N·m)

Wiring

When wiring, use wires of a size appropriate for the applied voltage and carry current. Perform soldering correctly under the conditions given below. Using the Switch with the wires soldered incorrectly may cause the terminals to become abnormally hot and cause a fire.

1. Hand soldering: At 30 W within 5 seconds.
2. Dip soldering: At 240°C within 3 seconds.

Wait for one minute after soldering before exerting any external force on the solder.

Use a non-corrosive rosin liquid for the flux.

Perform wiring so that the wire sheaths do not come into contact with the Switch. If this is unavoidable, use wires that can withstand temperatures of 100°C min.

After wiring to the Switch has been completed, ensure an appropriate insulation distance.

Operating Environment

Do not use in locations that are subject to dust, oil, or metal filings as these may penetrate the interior of the Switch and cause malfunction.

Using Microloads

Using a standard load switch for opening and closing a microload circuit may cause wear on the contacts. Use the switch within the operating range. (Refer to the diagram below.) Even when using microload models within the operating range shown below, if inrush current occurs when the contact is opened or closed, it may cause the contact surface to become rough, and so decrease life expectancy. Therefore, insert a contact protection circuit where necessary. The minimum applicable load is the N-level reference value. This value indicates the malfunction reference level for the reliability level of 60% ($\lambda 60$) (conforming to JIS C5003). The equation, $\lambda 60 = 0.5 \times 10^{-4}$ times indicates that the estimated malfunction rate is less than 1/2,000,000 with a reliability level of 60%.

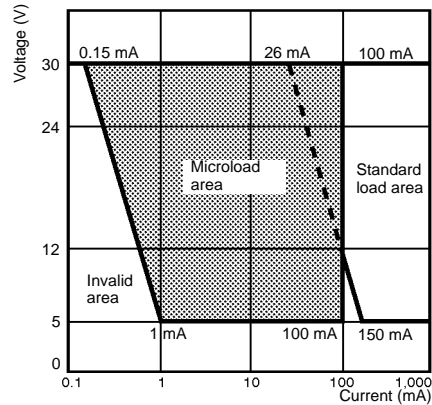

LED

Resistance to limit the LED current is provided internally and so an external resistance is not required.

Rated voltage	Internal limiting resistance
5 VDC	33 Ω
12 VDC	270 Ω
24 VDC	1600 Ω

ALL DIMENSIONS SHOWN ARE IN MILLIMETERS.
 To convert millimeters into inches, multiply by 0.03937. To convert grams into ounces, multiply by 0.03527.

Indicator with Cylindrical 20-mm × 12-dia. Body

- Same basic design as the A3C Pushbutton Switch.
- Good illumination with even surface brightness.
- Cylindrical body means panel cutouts can be made easily.
- UL (E41515) and CSA (LR45258) approved.

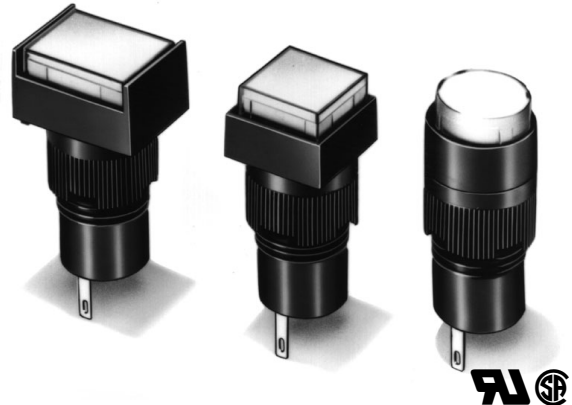



Ordering Information

■ Model Number Legend:

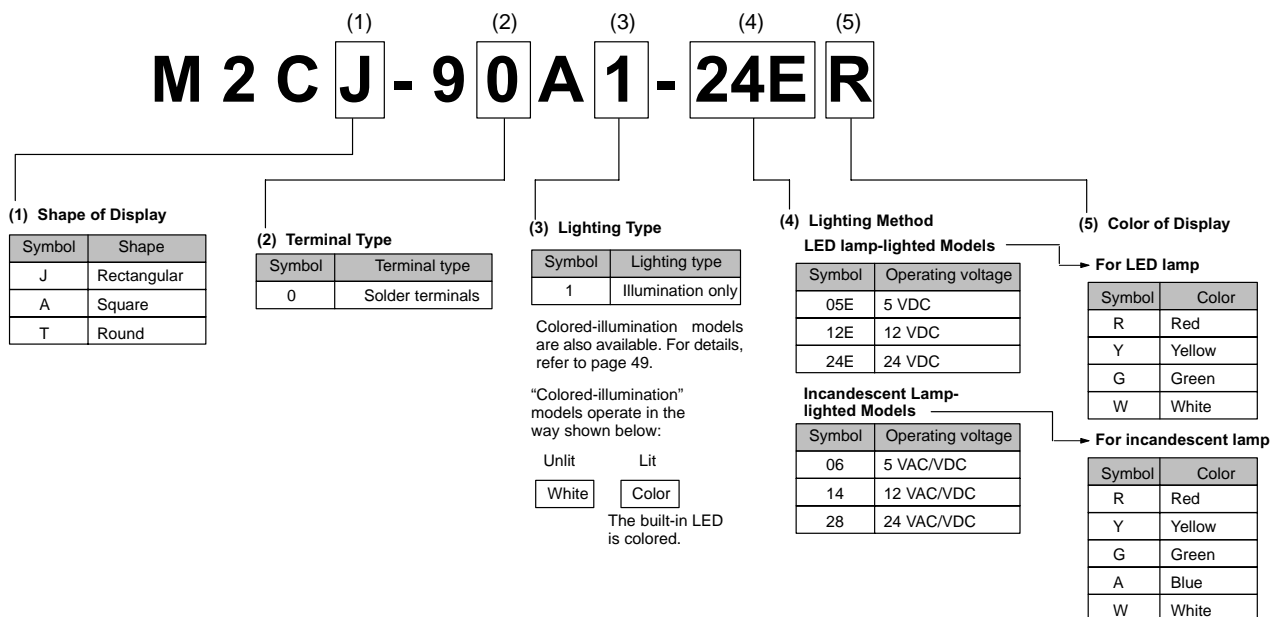
The model numbers used to order sets of Units are illustrated below. One set comprises the Display, Lamp, and Socket Unit.

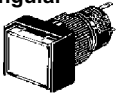
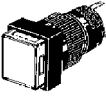

■ List of Models

Appearance	Model
Rectangular 	M2CJ
Square 	M2CA
Round 	M2CT

■ Ordering as a Set

The model numbers used to order sets of Units are given in the following tables. One set comprises the Display, Lamp, and Socket Unit.

Rectangular Models

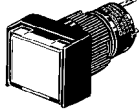

Square Models

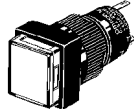

Round Models

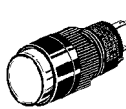

Indicators (Solder Terminals)

Appearance	Lighting	Model number (for set)	Display color symbol
Rectangular (M2CJ)	LED lamp	M2CJ-90A1-05E□	R: red Y: yellow G: green W: white
		M2CJ-90A1-12E□	
		M2CJ-90A1-24E□	
	Incandescent lamp	M2CJ-90A1-06□	R: red Y: yellow G: green W: white A: blue
		M2CJ-90A1-14□	
		M2CJ-90A1-28□	
Square (M2CA)	LED lamp	M2CA-90A1-05E□	R: red Y: yellow G: green W: white
		M2CA-90A1-12E□	
		M2CA-90A1-24E□	
	Incandescent lamp	M2CA-90A1-06□	R: red Y: yellow G: green W: white A: blue
		M2CA-90A1-14□	
		M2CA-90A1-28□	
Round (M2CT)	LED lamp	M2CT-90A1-05E□	R: red Y: yellow G: green W: white
		M2CT-90A1-12E□	
		M2CT-90A1-24E□	
	Incandescent lamp	M2CT-90A1-06□	R: red Y: yellow G: green W: white A: blue
		M2CT-90A1-14□	
		M2CT-90A1-28□	

Note: Enter the desired color symbol for the Display in the □ at the end of the model number.

■ Illumination-only and Colored-illumination LED Models

“Illumination only” describes LED models for which the screen color is the same whether the LED is lit or not. The screen simply becomes brighter when the LED lights.

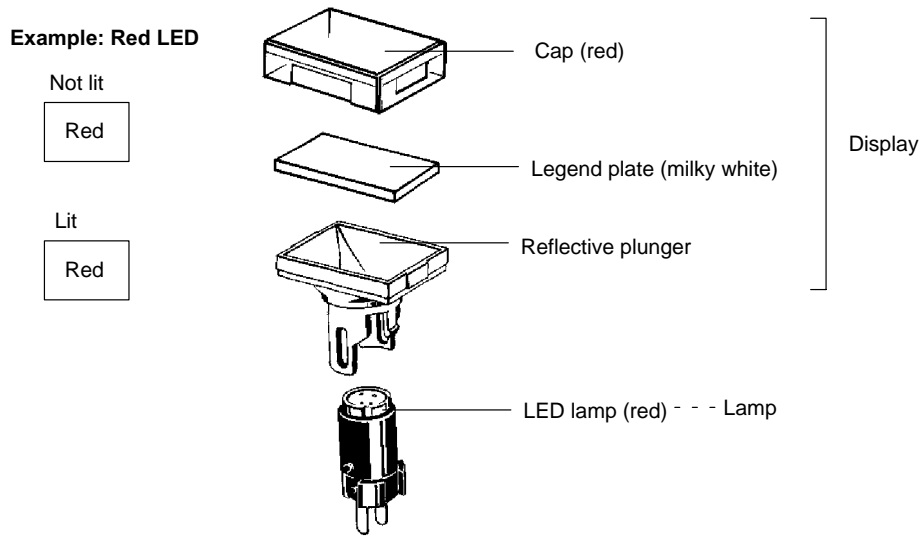

“Colored illumination” describes LED models for which the screen color is white when the LED is not lit and changes to the color of the LED lamp when the LED is lit.

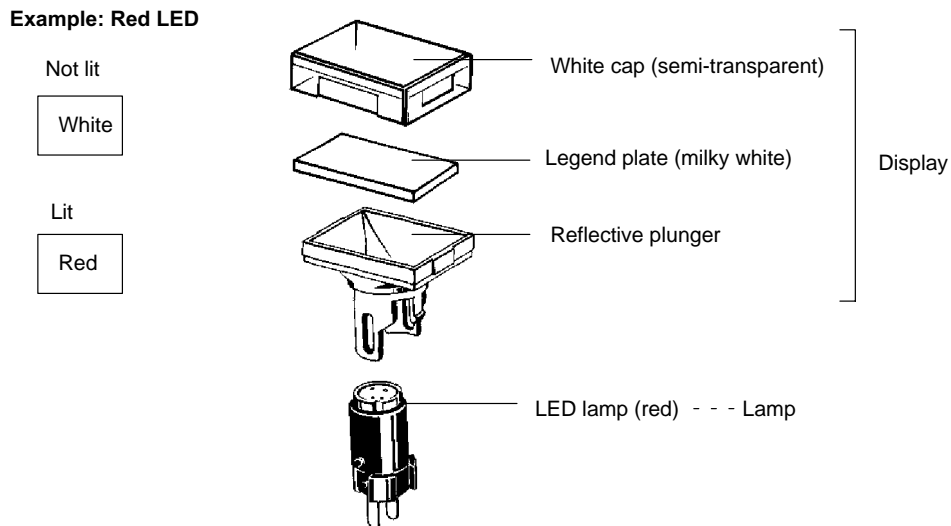

Ordering: With colored-illumination models, order the Display, Lamp, and Socket Unit as shown in the following table.

Illuminated color	Display	Lamp (LED)	Socket Unit
Red	IP40 A3C□-500W Enter one of the following symbols in □. J: Rectangular A: Square T: Round	A16-□DR	Refer to the following information. Order the Socket Unit that is appropriate for the Display.
Yellow		A16-□DY	
Green		A16-□DG	

Enter one of the following symbols in □.
5: 5 VDC
12: 12 VDC
24: 24 VDC

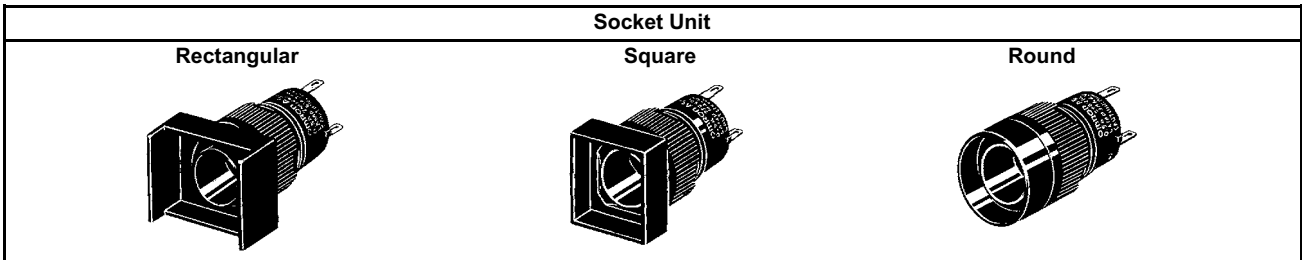
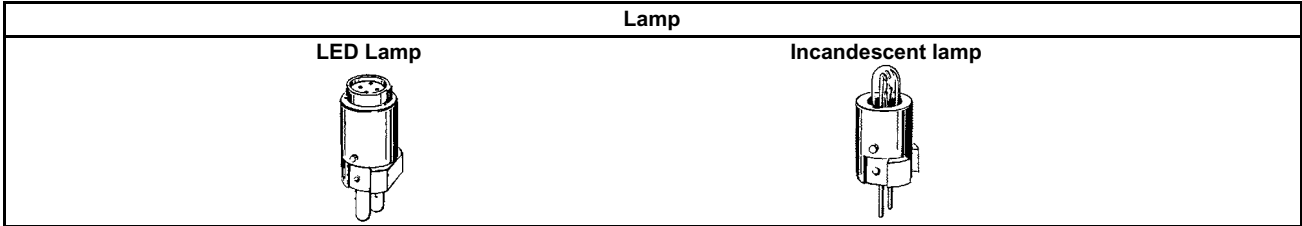
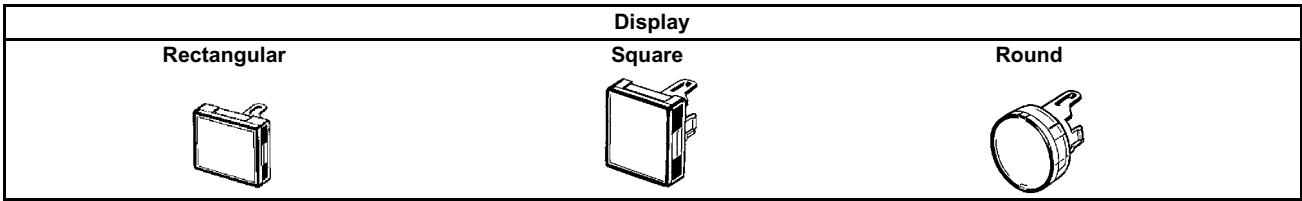

■ Ordering Individually

Displays, Lamps, and Socket Units can be ordered separately. Combinations that are not available as sets can be created using individual Units. Also, store the parts as spares for maintenance and repairs.



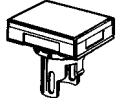
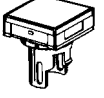

Display (Lighted Models)

LED Lamp

Button color	Rectangular	Square	Round
			
Red	A3CJ-500R	A3CA-500R	A3CT-500R
Yellow	A3CJ-500Y	A3CA-500Y	A3CT-500Y
Green	A3CJ-500GY	A3CA-500GY	A3CT-500GY
White	A3CJ-500W	A3CA-500W	A3CT-500W

Note: The red, yellow, and white Displays listed above can be used with either LED lamp-lighted models or incandescent lamp-lighted models.

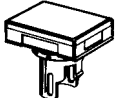
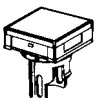
Incandescent Lamp

Button color	Rectangular	Square	Round
			
Red	A3CJ-500R	A3CA-500R	A3CT-500R
Yellow	A3CJ-500Y	A3CA-500Y	A3CT-500Y
Green	A3CJ-500G	A3CA-500G	A3CT-500G
White	A3CJ-500W	A3CA-500W	A3CT-500W
Blue	A3CJ-500A	A3CA-500A	A3CT-500A

Lamp

LED Lamp

Color	Rated voltage		
	5 VDC	12 VDC	24 VDC
Red	A16-5DR	A16-12DR	A16-24DR
Yellow	A16-5DY	A16-12DY	A16-24DY
Green	A16-5DG	A16-12DG	A16-24DG
White	A16-5DW	A16-12DW	A16-24DW

Incandescent Lamp

Rated voltage	Model
6 VAC/VDC	A16-5
14 VAC/VDC	A16-12
28 VAC/VDC	A16-24

Socket Unit

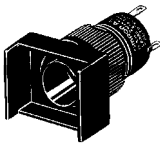
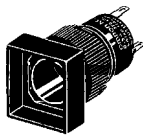
Terminal	Sealing Appearance	IP40	
			
Solder terminals	M2CJ-7001	M2CA-7001	M2CT-7001

■ Accessories

The accessories for the A3C Lighted Pushbutton Switch can also be used with the M2C. Refer to page 38.

Specifications

■ Ratings

LED Lamp

Rated voltage	Rated current	Operating voltage	Internal limiting resistance
5 VDC	30 mA	5 VDC \pm 5%	33 Ω
12 VDC	15 mA	12 VDC \pm 5%	270 Ω
24 VDC	10 mA	24 VDC \pm 5%	1,600 Ω

Incandescent Lamp

Rated voltage	Rated current	Operating voltage
6 VAC/VDC	60 mA	5 VAC/VDC
14 VAC/VDC	40 mA	12 VAC/VDC
28 VAC/VDC	24 mA	24 VAC/VDC

■ Characteristics

Ambient operating temperature	-10°C to 55°C (with no icing or condensation)
Ambient operating humidity	35% to 85%
Ambient storage temperature	-25°C to 65°C

■ Approved Standards

UL, CSA

Nomenclature

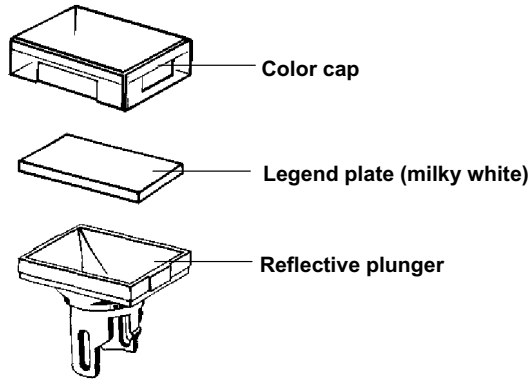

Display

Shape of Display

Rectangular (M2CJ)



Square (M2CA)



Round (M2CT)

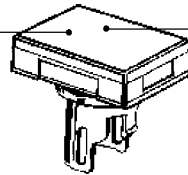

Color of Display

- LED Lamp-lighted Models: Red, yellow, green, white
- Incandescent Lamp-lighted Models: Red, yellow, green, white, blue



Lamp
LED Lamp



Incandescent Lamp

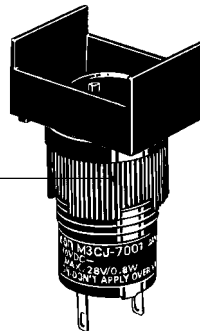

Socket Unit

Note: The M2CJ model is shown here as a representative example.

Dimensions

Note: All units are in millimeters unless otherwise indicated.

Rectangular Models (M2CJ)

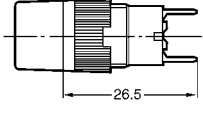
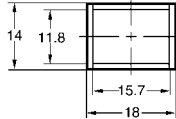
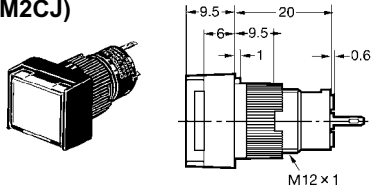

Square Models (M2CA)

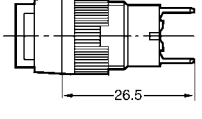
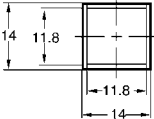
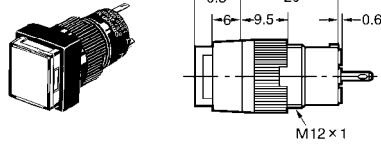

Round Models (M2CT)

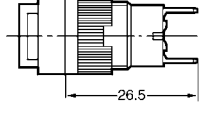
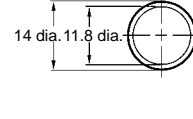
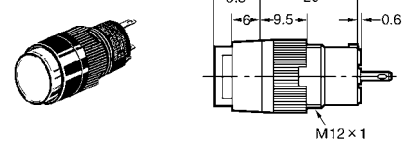

Note: Unless specified, there is a tolerance of ± 0.4 mm for dimensions.

Operation

Panel Cutout (Top View)

Accessories used	Rectangular/M2CJ	Square/M2CA, Round/M2CT
Indicator Unit only	<p>Note: Recommended panel thickness: 1.0 to 3.2 mm.</p>	<p>Note: Recommended panel thickness: 1.0 to 3.2 mm.</p>
With Dust Cover		---

Note: If the panel is to be finished (e.g., coated), make sure that the panel meets the specified dimensions after the coating.

Terminal Connections

Terminal	Type
	SPST-NO+SPST-NC
Solder terminal	<p>Lighted and non-lighted models</p> <div style="display: flex; justify-content: space-around;"> <div style="text-align: center;"> <p>Terminal Hole Dimensions</p> </div> <div style="text-align: center;"> <p>Terminal Arrangement (bottom view)</p> </div> </div>

Precautions

■ Correct Use

Refer to the *Common Precautions* for Pushbutton Switches on page 14.
Refer to *Correct Use* for A3C on page 46.

ALL DIMENSIONS SHOWN ARE IN MILLIMETERS.

To convert millimeters into inches, multiply by 0.03937. To convert grams into ounces, multiply by 0.03527.

Pushbutton Switch A16

Mounting Aperture of 16 mm

- Modular construction (Pushbutton + Case + Lamp + Switch)
- Wide Variety of Control and Signal Devices: Lighted, Non-Lighted, and Buzzer
- UL and cUL approved.
- Conforms to EN60947-5-1, IEC947-5-1
- Quick and easy assembly, snap-in Switch.
- Wide range of switching capacity from standard to microload
- High reliability, IP65
- Short mounting depth, less than 28.5 mm below panel

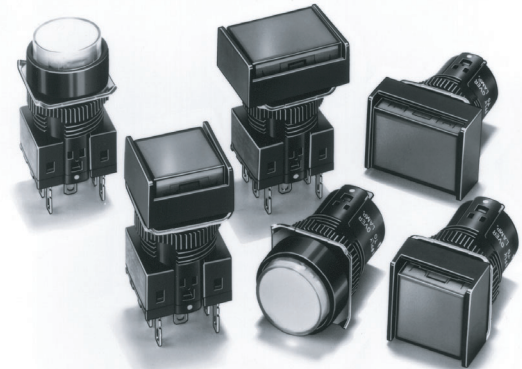

Model Number Structure

Model Number Legend

Completely Assembled

The model numbers used to order sets of Units are illustrated below. One set comprises the Pushbutton, Lamp (lighted models only), Case, and Switch.

A
1
6
5
L
-
J
R
M
-
24
D
-
2

(1) Degree of Protection

Symbol	Protection
No symbol	IP40
5	IP65 oil-resistant

(2) Lighted/Non-lighted

Symbol	Type
No symbol	Non-lighted
L	Lighted

(3) Shape of Pushbutton

Symbol	Shape
J	Rectangular 2-way guard
A	Square 2-way guard
T	Round Projecting model

(4) Color of Pushbutton

Symbol	Color
R	Red
Y	Yellow
PY	Pure yellow
G	Green
W	White
A	Blue
B	Black (non-lighted models only)

"Colored-illumination" models operate in the way shown below:

Unlit	Lit
White	Color

The built-in LED is colored.

(5) Switch Operation

Symbol	Operation
M	Momentary
A	Alternate

Momentary-action: Self-resetting
Alternate-action: Self-holding

(6) Light Source

Symbol	Type	Operating voltage	Rated voltage
No symbol	Non-lighted		
5	Incandescent lamp	5 VAC/VDC	6 VAC/VDC
12		12 VAC/VDC	14 VAC/VDC
24		24 VAC/VDC	28 VAC/VDC
5D	LED	5 ±5% VDC	5 VDC
12D		12 ±5% VDC	12 VDC
24D		24 ±5% VDC	24 VDC

Voltage Reduction Unit (24-V Built-in LED)

Symbol	Type	Operating voltage	Rated voltage
T1	LED	90 to 121 VAC/VDC	110 VAC
T2		180 to 242 VAC/VDC	220 VAC





(7) Contact Configuration

Symbol	Type	Terminal
1	SPDT	Solder Terminal
2	DPDT	PCB Terminal
1P	SPDT	PCB Terminal
2P	DPDT	PCB Terminal
2S	DPDT	Screw-Less Clamp

Only DPDT contacts are available with Screw-Less Clamp.

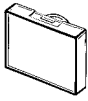
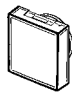
- Note:**
1. Solder terminals are available only with 100-V models.
 2. The Voltage Reduction Unit is not available for models with PCB terminals.
 3. "T2" is available only for the Screw-Less Clamp type.

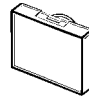
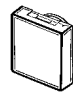
Neon lamps are not available with models that are ordered as a set. They must be ordered individually if required. Refer to page 62.

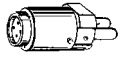
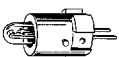
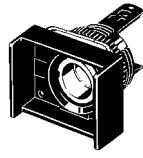
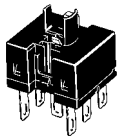
Model	Lighted Pushbutton Switches	Non-lighted Pushbutton Switches
Pushbutton	<p>Rectangular </p> <p>Square </p> <p>Round </p>	<p>Rectangular </p> <p>Square </p> <p>Round </p>
Lamp	<p>LED lamp  Incandescent lamp </p>	
Case		
Switch	<p>Solder Terminals (Without Voltage Reduction Unit)</p> 	

Note: There is no Lamp with non-lighted models.

Subassembled

1. Pushbutton

Non-lighted/Lighted

A16□L-□□
1 2 3

1. Degree of Protection

None: IP40

5: IP65

2. Flange Shape

J: Rectangular

T: Round

A: Square

3. Illumination Color for Non-lighted Models

R: Red

G: Green

Y: Yellow

W: White

A: Blue

B: Black

Illumination Color for Lighted Models

LED/Incandescent Lamp

R: Red

Y: Yellow

PY: Pure yellow

W: White

A: Blue

LED

GY: Green

Incandescent Lamp

G: Green

2. Lamp

A16-□□
1 2

1. Operating Voltage (Rated Voltage)

Incandescent Lamp

- 5: 5 VAC/VDC (6 VAC/VDC)
- 12: 12 VAC/VDC (14 VAC/VDC)
- 24: 24 VAC/VDC (28 VAC/VDC)

LED

- 5DS: 5 VDC (5 VDC)
- 12DS: 12 VDC (12 VDC)
- 24DS: 24 VDC (24 VDC)

2. Illumination Color

- None: Incandescent Lamp
- R: Red (LED)
- G: Green (LED)
- Y: Yellow (LED)
- W: White (LED)
- A: Blue (LED)

3. Case

A16□-□□□
1 2 3

1. Degree of Protection

- None: IP40
- 5: IP65 Oil-resistant

2. Flange Shape

- CJ: Rectangular
- CT: Round
- CA: Square

3. Switch Action

- M: Momentary
- A: Alternate

4. Switch (Solder Terminals)

A16-□-□
1 2

1. Voltage Reduction Circuit

(Operating Voltage/Rated Voltage)

- None: Without Voltage Reduction Unit
- T1: 100 VAC/110 VAC

2. Contacts

- 1: SPDT
- 2: DPDT

5. Socket (Solder Terminals Only)

M16-□
1

1. Voltage Reduction Circuit

(Operating Voltage/Rated Voltage)

- 0: Without Voltage Reduction Unit
- T1: 100 VAC/110 VAC

Ordering Information

List of Models

Ordering as a Set

The model numbers used to order sets of Units are given in the following tables. One set comprises the Pushbutton, Lamp (lighted models only), Case, and Switch.

A16□-J (Rectangular) Models

Solder Terminal Models

IP40

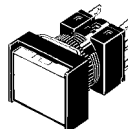

Output	Lighting	Operating voltage	Momentary operation (Self-resetting)	Alternate operation (Self-holding)	Pushbutton color symbol (See note 1.)			
SPDT	LED without Voltage Reduction Unit	5 VDC	A16L-J□M-5D-1	A16L-J□A-5D-1	R: red Y: yellow PY: pure yellow G: green A: blue W: white			
		12 VDC	A16L-J□M-12D-1	A16L-J□A-12D-1				
		24 VDC	A16L-J□M-24D-1	A16L-J□A-24D-1				
	Incandescent lamp	5 VDC/VAC	A16L-J□M-5-1	A16L-J□A-5-1		R: red Y: yellow PY: pure yellow G: green W: white A: blue B: black (See note 2.)		
		12 VDC/VAC	A16L-J□M-12-1	A16L-J□A-12-1				
		24 VDC/VAC	A16L-J□M-24-1	A16L-J□A-24-1				
	Non-lighted			A16-J□M-1			A16-J□A-1	
	DPDT	LED without Voltage Reduction Unit	5 VDC	A16L-J□M-5D-2			A16L-J□A-5D-2	R: red Y: yellow PY: pure yellow G: green A: blue W: white
			12 VDC	A16L-J□M-12D-2			A16L-J□A-12D-2	
24 VDC			A16L-J□M-24D-2	A16L-J□A-24D-2				
Incandescent lamp		5 VDC/VAC	A16L-J□M-5-2	A16L-J□A-5-2	R: red Y: yellow PY: pure yellow G: green W: white A: blue B: black (See note 2.)			
		12 VDC/VAC	A16L-J□M-12-2	A16L-J□A-12-2				
		24 VDC/VAC	A16L-J□M-24-2	A16L-J□A-24-2				
Non-lighted			A16-J□M-2	A16-J□A-2				

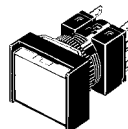

IP65 Oil-resistant

Output	Lighting	Operating voltage	Momentary operation (Self-resetting)	Alternate operation (Self-holding)	Pushbutton color symbol (See note 1.)			
SPDT	LED without Voltage Reduction Unit	5 VDC	A165L-J□M-5D-1	A165L-J□A-5D-1	R: red Y: yellow PY: pure yellow G: green A: blue W: white			
		12 VDC	A165L-J□M-12D-1	A165L-J□A-12D-1				
		24 VDC	A165L-J□M-24D-1	A165L-J□A-24D-1				
	Incandescent lamp	5 VDC/VAC	A165L-J□M-5-1	A165L-J□A-5-1		R: red Y: yellow PY: pure yellow G: green W: white A: blue B: black (See note 2.)		
		12 VDC/VAC	A165L-J□M-12-1	A165L-J□A-12-1				
		24 VDC/VAC	A165L-J□M-24-1	A165L-J□A-24-1				
	Non-lighted			A165-J□M-1			A165-J□A-1	
	DPDT	LED without Voltage Reduction Unit	5 VDC	A165L-J□M-5D-2			A165L-J□A-5D-2	R: red Y: yellow PY: pure yellow G: green A: blue W: white
			12 VDC	A165L-J□M-12D-2			A165L-J□A-12D-2	
24 VDC			A165L-J□M-24D-2	A165L-J□A-24D-2				
Incandescent lamp		5 VDC/VAC	A165L-J□M-5-2	A165L-J□A-5-2	R: red Y: yellow PY: pure yellow G: green W: white A: blue B: black (See note 2.)			
		12 VDC/VAC	A165L-J□M-12-2	A165L-J□A-12-2				
		24 VDC/VAC	A165L-J□M-24-2	A165L-J□A-24-2				
Non-lighted			A165-J□M-2	A165-J□A-2				

Note: 1. Enter the desired color symbol for the Pushbutton in the □.

2. Black ("B") Pushbuttons are only available for non-lighted models.

A16□-A (Square) Models

Solder Terminal Models

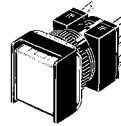

IP40

Output	Lighting	Operating voltage	Momentary operation (Self-resetting)	Alternate operation (Self-holding)	Pushbutton color symbol (See note 1.)			
SPDT	LED without Voltage Reduction Unit	5 VDC	A16L-A□M-5D-1	A16L-A□A-5D-1	R: red Y: yellow PY: pure yellow G: green A: blue W: white			
		12 VDC	A16L-A□M-12D-1	A16L-A□A-12D-1				
		24 VDC	A16L-A□M-24D-1	A16L-A□A-24D-1				
	Incandescent lamp	5 VDC/VAC	A16L-A□M-5-1	A16L-A□A-5-1		R: red Y: yellow PY: pure yellow G: green W: white A: blue B: black (See note 2.)		
		12 VDC/VAC	A16L-A□M-12-1	A16L-A□A-12-1				
		24 VDC/VAC	A16L-A□M-24-1	A16L-A□A-24-1				
	Non-lighted		A16-A□M-1	A16-A□A-1				
	DPDT	LED without Voltage Reduction Unit	5 VDC	A16L-A□M-5D-2			A16L-A□A-5D-2	R: red Y: yellow PY: pure yellow G: green A: blue W: white
			12 VDC	A16L-A□M-12D-2			A16L-A□A-12D-2	
24 VDC			A16L-A□M-24D-2	A16L-A□A-24D-2				
Incandescent lamp		5 VDC/VAC	A16L-A□M-5-2	A16L-A□A-5-2	R: red Y: yellow PY: pure yellow G: green W: white A: blue B: black (See note 2.)			
		12 VDC/VAC	A16L-A□M-12-2	A16L-A□A-12-2				
		24 VDC/VAC	A16L-A□M-24-2	A16L-A□A-24-2				
Non-lighted		A16-A□M-2	A16-A□A-2					

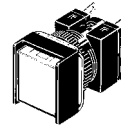

IP65 Oil-resistant

Output	Lighting	Operating voltage	Momentary operation (Self-resetting)	Alternate operation (Self-holding)	Pushbutton color symbol (See note 1.)			
SPDT	LED without Voltage Reduction Unit	5 VDC	A165L-A□M-5D-1	A165L-A□A-5D-1	R: red Y: yellow PY: pure yellow G: green A: blue W: white			
		12 VDC	A165L-A□M-12D-1	A165L-A□A-12D-1				
		24 VDC	A165L-A□M-24D-1	A165L-A□A-24D-1				
	Incandescent lamp	5 VDC/VAC	A165L-A□M-5-1	A165L-A□A-5-1		R: red Y: yellow PY: pure yellow G: green W: white A: blue B: black (See note 2.)		
		12 VDC/VAC	A165L-A□M-12-1	A165L-A□A-12-1				
		24 VDC/VAC	A165L-A□M-24-1	A165L-A□A-24-1				
	Non-lighted		A165-A□M-1	A165-A□A-1				
	DPDT	LED without Voltage Reduction Unit	5 VDC	A165L-A□M-5D-2			A165L-A□A-5D-2	R: red Y: yellow PY: pure yellow G: green A: blue W: white
			12 VDC	A165L-A□M-12D-2			A165L-A□A-12D-2	
24 VDC			A165L-A□M-24D-2	A165L-A□A-24D-2				
Incandescent lamp		5 VDC/VAC	A165L-A□M-5-2	A165L-A□A-5-2	R: red Y: yellow PY: pure yellow G: green W: white A: blue B: black (See note 2.)			
		12 VDC/VAC	A165L-A□M-12-2	A165L-A□A-12-2				
		24 VDC/VAC	A165L-A□M-24-2	A165L-A□A-24-2				
Non-lighted		A165-A□M-2	A165-A□A-2					

- Note:** 1. Enter the desired color symbol for the Pushbutton in the □.
 2. Black ("B") Pushbuttons are only available for non-lighted models.

A16□-T (Round) Models

Solder Terminals

IP40



Output	Lighting	Operating voltage	Momentary operation (Self-resetting)	Alternate operation (Self-holding)	Pushbutton color symbol (See note 1.)	
SPDT	LED without Voltage Reduction Unit	5 VDC	A16L-T□M-5D-1	A16L-T□A-5D-1	R: red Y: yellow PY: pure yellow G: green A: blue W: white	
		12 VDC	A16L-T□M-12D-1	A16L-T□A-12D-1		
		24 VDC	A16L-T□M-24D-1	A16L-T□A-24D-1		
	Incandescent lamp	5 VDC/VAC	A16L-T□M-5-1	A16L-T□A-5-1	R: red Y: yellow PY: pure yellow G: green W: white A: blue B: black (See note 2.)	
		12 VDC/VAC	A16L-T□M-12-1	A16L-T□A-12-1		
		24 VDC/VAC	A16L-T□M-24-1	A16L-T□A-24-1		
	Non-lighted			A16-T□M-1	A16-T□A-1	
	DPDT	LED without Voltage Reduction Unit	5 VDC	A16L-T□M-5D-2	A16L-T□A-5D-2	R: red Y: yellow PY: pure yellow G: green A: blue W: white
			12 VDC	A16L-T□M-12D-2	A16L-T□A-12D-2	
24 VDC			A16L-T□M-24D-2	A16L-T□A-24D-2		
Incandescent lamp		5 VDC/VAC	A16L-T□M-5-2	A16L-T□A-5-2	R: red Y: yellow PY: pure yellow G: green W: white A: blue B: black (See note 2.)	
		12 VDC/VAC	A16L-T□M-12-2	A16L-T□A-12-2		
		24 VDC/VAC	A16L-T□M-24-2	A16L-T□A-24-2		
Non-lighted			A16-T□M-2	A16-T□A-2		



IP65 Oil-resistant

Output	Lighting	Operating voltage	Momentary operation (Self-resetting)	Alternate operation (Self-holding)	Pushbutton color symbol (See note 1.)	
SPDT	LED without Voltage Reduction Unit	5 VDC	A165L-T□M-5D-1	A165L-T□A-5D-1	R: red Y: yellow PY: pure yellow G: green A: blue W: white	
		12 VDC	A165L-T□M-12D-1	A165L-T□A-12D-1		
		24 VDC	A165L-T□M-24D-1	A165L-T□A-24D-1		
	Incandescent lamp	5 VDC/VAC	A165L-T□M-5-1	A165L-T□A-5-1	R: red Y: yellow PY: pure yellow G: green W: white A: blue B: black (See note 2.)	
		12 VDC/VAC	A165L-T□M-12-1	A165L-T□A-12-1		
		24 VDC/VAC	A165L-T□M-24-1	A165L-T□A-24-1		
	Non-lighted			A165-T□M-1	A165-T□A-1	
	DPDT	LED without Voltage Reduction Unit	5 VDC	A165L-T□M-5D-2	A165L-T□A-5D-2	R: red Y: yellow PY: pure yellow G: green A: blue W: white
			12 VDC	A165L-T□M-12D-2	A165L-T□A-12D-2	
24 VDC			A165L-T□M-24D-2	A165L-T□A-24D-2		
Incandescent lamp		5 VDC/VAC	A165L-T□M-5-2	A165L-T□A-5-2	R: red Y: yellow PY: pure yellow G: green W: white A: blue B: black (See note 2.)	
		12 VDC/VAC	A165L-T□M-12-2	A165L-T□A-12-2		
		24 VDC/VAC	A165L-T□M-24-2	A165L-T□A-24-2		
Non-lighted			A165-T□M-2	A165-T□A-2		

- Note:** 1. Enter the desired color symbol for the Pushbutton in the □.
 2. Black ("B") Pushbuttons are only available for non-lighted models.

Other Models

Models with Reduced-voltage Lighting and Solder Terminals

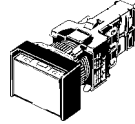

IP40

Output	Lighting	Operating voltage	Momentary operation (Self-resetting)	Alternate operation (Self-holding)	Pushbutton color symbol (See note 1.)
SPDT	LED (with built-in reduced-voltage lighting function)	100/110 VAC/VDC	A16L-Δ□M-T1-1	A16L-Δ□A-T1-1	R: red Y: yellow PY: pure yellow G: green W: white A: blue
DPDT		100/110 VAC/VDC	A16L-Δ□M-T1-2	A16L-Δ□A-T1-2	

IP65

Output	Lighting	Operating voltage	Momentary operation (Self-resetting)	Alternate operation (Self-holding)	Pushbutton color symbol (See note 1.)
SPDT	LED (with built-in reduced-voltage lighting function)	100/110 VAC/VDC	A165L-Δ□M-T1-1	A165L-Δ□A-T1-1	R: red Y: yellow PY: pure yellow G: green W: white A: blue
DPDT		100/110 VAC/VDC	A165L-Δ□M-T1-2	A165L-Δ□A-T1-2	

- Note:** 1. Enter the desired shape for the Pushbutton in Δ: J (rectangular), A (square), or T (round). Enter the desired color symbol for the Pushbutton in the □.
 2. Models with rated voltage 200 to 220 VAC/VDC (T2 models) are only available with Screw-Less Clamps.

Screw-Less Clamp Models

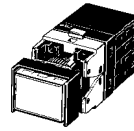

IP40

Output	Lighting	Operating voltage	Momentary operation (Self-resetting)	Alternate operation (Self-holding)	Pushbutton color symbol (See note 1.)
DPDT	LED	5 VDC	A16L-Δ□M-5D-2S	A16L-Δ□A-5D-2S	R: red Y: yellow PY: pure yellow G: green W: white A: blue B: black (See note 2.)
		12 VDC	A16L-Δ□M-12D-2S	A16L-Δ□A-12D-2S	
		24 VDC	A16L-Δ□M-24D-2S	A16L-Δ□A-24D-2S	
	LED (with built-in reduced-voltage lighting function)	100/110 VAC/VDC	A16L-Δ□M-T1-2S	A16L-Δ□A-T1-2S	
		200/220 VAC/VDC	A16L-Δ□M-T2-2S	A16L-Δ□A-T2-2S	
Non-lighted		A16L-Δ□M-2S	A16L-Δ□A-2S		

IP65

Output	Lighting	Operating voltage	Momentary operation (Self-resetting)	Alternate operation (Self-holding)	Pushbutton color symbol (See note 1.)
DPDT	LED	5 VDC	A165L-Δ□M-5D-2S	A165L-Δ□A-5D-2S	R: red Y: yellow PY: pure yellow G: green W: white A: blue B: black (See note 2.)
		12 VDC	A165L-Δ□M-12D-2S	A165L-Δ□A-12D-2S	
		24 VDC	A165L-Δ□M-24D-2S	A165L-Δ□A-24D-2S	
	LED (with built-in reduced-voltage lighting function)	100/110 VAC/VDC	A165L-Δ□M-T1-2S	A165L-Δ□A-T1-2S	
		200/220 VAC/VDC	A165L-Δ□M-T2-2S	A165L-Δ□A-T2-2S	
Non-lighted		A165L-Δ□M-2S	A165L-Δ□A-2S		

- Note:** 1. Enter the desired shape for the Pushbutton in Δ: J (rectangular), A (square), or T (round). Enter the desired color symbol for the Pushbutton in the □.
 2. Black ("B") Pushbuttons are only available for non-lighted models.

Ordering Individually



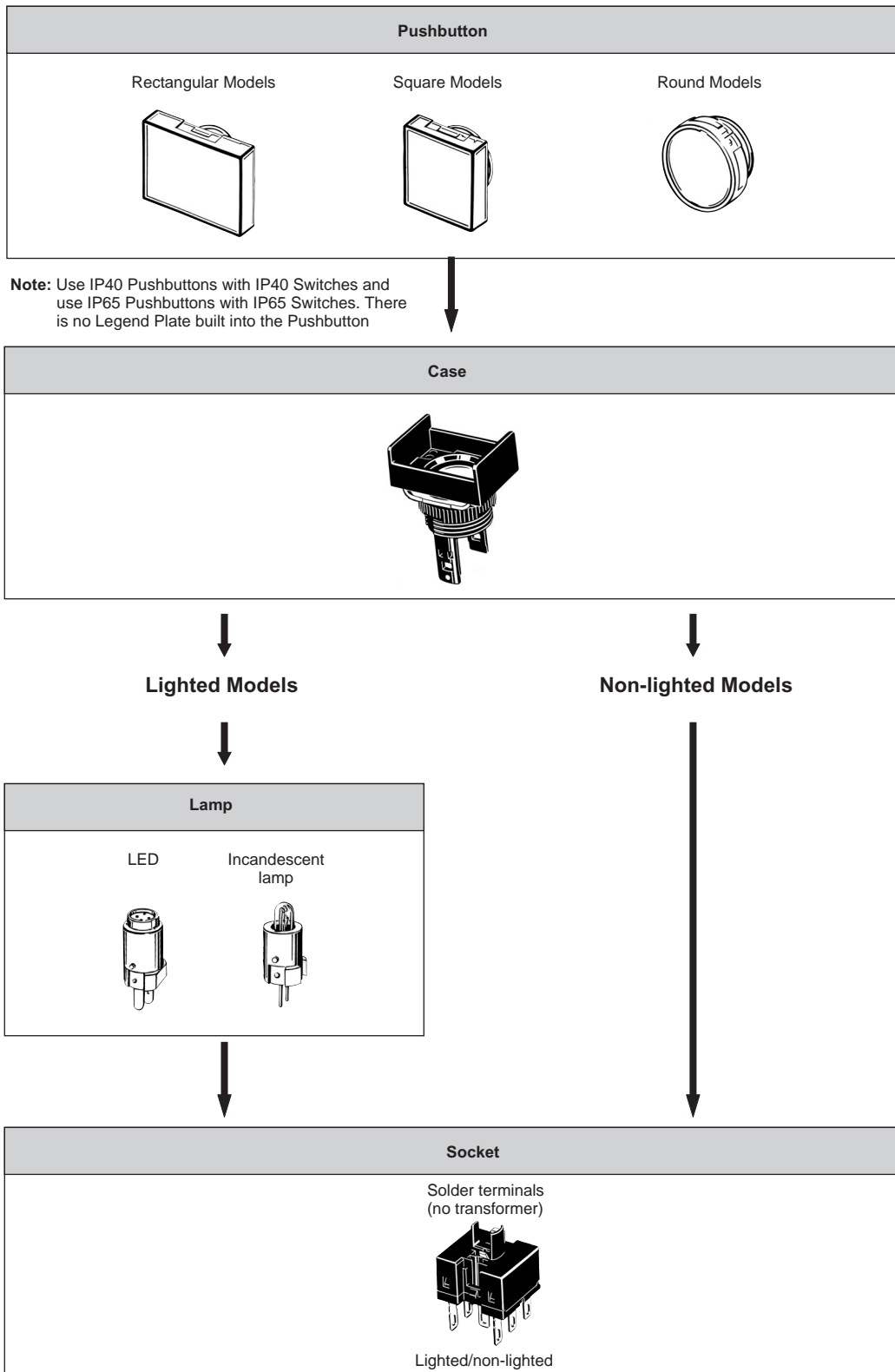



Pushbuttons, Lamps, Cases, and Switches (Sockets) can be ordered separately. Combinations that are not available as sets can be created using individual Units. Also, store the parts as spares for maintenance and repairs.









Pushbuttons

Illumination: red, yellow, and white use either LED or incandescent lamps.







LED

Degree of protection	IP40			Oil-resistant IP65		
	Rectangular 	Square 	Round 	Rectangular 	Square 	Round 
Red	A16L-JR	A16L-AR	A16L-TR	A165L-JR	A165L-AR	A165L-TR
Yellow	A16L-JY	A16L-AY	A16L-TY	A165L-JY	A165L-AY	A165L-TY
Pure yellow	A16L-JPY	A16L-APY	A16L-TPY	A165L-JPY	A165L-APY	A165L-TPY
Green	A16L-JGY	A16L-AGY	A16L-TGY	A165L-JGY	A165L-AGY	A165L-TGY
White	A16L-JW	A16L-AW	A16L-TW	A165L-JW	A165L-AW	A165L-TW
Blue	A16L-JA	A16L-AA	A16L-TA	A165L-JA	A165L-AA	A165L-TA



Incandescent Lamps (With the exception of green, the Units are the same as for LEDs.)

Degree of protection	IP40			Oil-resistant IP65		
	Rectangular 	Square 	Round 	Rectangular 	Square 	Round 
Red	A16L-JR	A16L-AR	A16L-TR	A165L-JR	A165L-AR	A165L-TR
Yellow	A16L-JY	A16L-AY	A16L-TY	A165L-JY	A165L-AY	A165L-TY
Pure yellow	A16L-JPY	A16L-APY	A16L-TPY	A165L-JPY	A165L-APY	A165L-TPY
Green	A16L-JG	A16L-AG	A16L-TG	A165L-JG	A165L-AG	A165L-TG
White	A16L-JW	A16L-AW	A16L-TW	A165L-JW	A165L-AW	A165L-TW
Blue	A16L-JA	A16L-AA	A16L-TA	A165L-JA	A165L-AA	A165L-TA

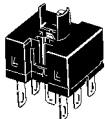
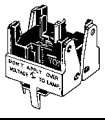

Non-lighted (Same as Units for incandescent lamps.)

Degree of protection	IP40			Oil-resistant IP65		
	Rectangular 	Square 	Round 	Rectangular 	Square 	Round 
Red	A16L-JR	A16L-AR	A16L-TR	A165L-JR	A165L-AR	A165L-TR
Yellow	A16L-JY	A16L-AY	A16L-TY	A165L-JY	A165L-AY	A165L-TY
Pure yellow	A16L-JPY	A16L-APY	A16L-TPY	A165L-JPY	A165L-APY	A165L-TPY
Green	A16L-JG	A16L-AG	A16L-TG	A165L-JG	A165L-AG	A165L-TG
White	A16L-JW	A16L-AW	A16L-TW	A165L-JW	A165L-AW	A165L-TW
Blue	A16L-JA	A16L-AA	A16L-TA	A165L-JA	A165L-AA	A165L-TA
Black	A16L-JB	A16L-AB	A16L-TB	A165L-JB	A165L-AB	A165L-TB

Switches

Appearance	Classification			Model	
	Lighted/non-lighted (common use)	Standard load/microload (common use)	SPDT	Solder terminal	A16-1
			DPDT		A16-2
			SPDT	PCB terminal	A16-1P
			DPDT		A16-2P
			DPDT	Screw-Less Clamp	A16-2S

Switches with Reduced-voltage Lighting

Appearance	Classification			Model	
	100 V	Standard load/microload (common use)	SPDT	Solder terminal	A16-T1-1
			DPDT		A16-T1-2
	100 V		DPDT	Screw-less clamp	A16-T1-2S
	200 V				A16-T2-2S

Lamps

LED

Operating voltage		5 VDC	12 VDC	24 VDC
Light color				
Red		A16-5DSR	A16-12DSR	A16-24DSR
Yellow		A16-5DSY	A16-12DSY	A16-24DSY
Green		A16-5DSG	A16-12DSG	A16-24DSG
White (See note.)		A16-5DSW	A16-12DSW	A16-24DSW
Blue		A16-5DA	A16-12DA	A16-24DA

Note: Use the white LED together with white or pure yellow Pushbuttons.

Incandescent Lamp

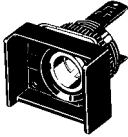

Operating voltage		5 VAC/VDC	12 VAC/VDC	24 VAC/VDC
				
Model		A16-5	A16-12	A16-24

Cases



Appearance	Classification			Model
	IP40	Momentary operation	Rectangular (2-way guard)	A16-CJM
			Square	A16-CAM
			Round	A16-CTM
		Alternate operation	Rectangular (2-way guard)	A16-CJA
			Square	A16-CAA
			Round	A16-CTA
	Oil-resistant IP65	Momentary operation	Rectangular (2-way guard)	A165-CJM
			Square	A165-CAM
		Alternate operation	Rectangular (2-way guard)	A165-CJA
			Square	A165-CAA
		Round	A165-CTA	

Accessories (Order Separately)

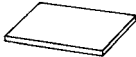
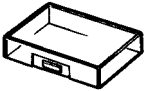

Accessories

Name	Appearance	Classification	Model	Remarks
Switch Guards		For rectangular models	A16ZJ-5050	Cannot be used with the Dust Cover.
		For square and round models	A16ZA-5050	
Dust Covers		For rectangular models	A16ZJ-5060	Cannot be used with the Switch Guard.
		For square models	A16ZA-5060	
		For round models	A16ZT-5060	
Panel Plugs		For rectangular models	A16ZJ-3003	Used for covering the panel cutouts for future panel expansion. Protective structure: IP40 Color: Black
		For square models	A16ZA-3003	
		For round models	A16ZT-3003	

Replacements

Name	Appearance	Classification		Model	Remarks	
Legend Plates		Rectangular	IP40	Milky	A16ZJ-5204	A single Legend Plate (transparent) is included with a standard model. The milky Legend Plate can be used with the IP40 and oil-resistant IP65.
				Transparent	A16ZJ-5202	
			Oil-resistant IP65	Milky	A16ZJ-5204	
				Transparent	A16ZJ-5203	
		Square	IP40	Milky	A16ZA-5204	
				Transparent	A16ZA-5202	
			Oil-resistant IP65	Milky	A16ZA-5204	
				Transparent	A16ZA-5203	
		Round	IP40	Milky	A16ZT-5204	
				Transparent	A16ZT-5202	
Oil-resistant IP65	Milky		A16ZT-5204			
	Transparent		A16ZT-5203			
Color Caps (for IP40)	Rectangular 	LED indicator/incandescent lamp/non-lighted	White	A16Z□-5001W	Insert one of the following letters into the box (□). J: Rectangular A: Square T: Round The Color Cap is usually supplied. Replace the Cap if the color is to be changed. When using an LED indicator, be sure to use a Color Cap that matches the luminescent color of the LED. The materials used for the IP40 and oil-resistant IP65 are different so be sure to use a Color Cap that matches the specifications of the Switch.	
			Red	A16Z□-5001R		
			Yellow	A16Z□-5001Y		
			Pure yellow	A16Z□-5001PY		
			Blue	A16Z□-5001A		
	Square 	LED indicator	Green	A16Z□-5001GY		
		Incandescent lamp/non-lighted	Green	A16Z□-5001G		
			Non-lighted	Black		A16Z□-5011B
	Round 	LED indicator/incandescent lamp/non-lighted	White	A16Z□-5101W		
			Red	A16Z□-5101R		
Yellow			A16Z□-5101Y			
Pure yellow			A16Z□-5101PY			
Blue		A16Z□-5101A				
LED indicator		Green	A16Z□-5101GY			
	Incandescent lamp/non-lighted	Green	A16Z□-5101G			
Color Caps (for oil-resistant IP65)	Non-lighted	Black	A16Z□-5111B			

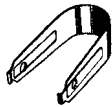
Tools

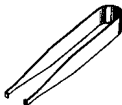
Name	Appearance	Model	Applicable types					Remarks
			Pushbutton Switch	Knob-type Selector Switch	Key-type Selector Switch	Emergency Stop Switch	Indicator	
Extractor		A3PJ-5080	Yes	No	No	No	Yes	Convenient for extracting Pushbutton Switches
Screw Fitting		A16Z-3004	Yes	Yes	Yes	Yes	Yes	Convenient for ganged installation. Tighten to a torque of 0.39 N · m min.
Extractor		A16Z-5080	Yes	Yes	Yes	Yes	Yes	Convenient for extracting the Switch and Lamps.

Specifications

Approved Standards

Agency	Standards	File No.
UL, cUL (See note.)	UL508	E41515
---	EN60947-5-1	---

Note: cUL: CSA, C22.2 No. 14

Approved Standard Ratings

UL, cUL (File No. E41515)

5 A at 125 VAC, 3 A at 250 VAC (general use)
3 A at 30 VDC (resistive)

EN60947-5-1 (Low Voltage Directive)

3 A at 250 VAC (AC12), 3 A at 30 VDC (DC12)

Ratings

Contacts

AC resistive load	DC resistive load
3 A at 250 VAC 5 A at 125 VAC	3 A at 30 VDC

Minimum applicable load: 1 mA at 5 VDC
Rated values are obtained from tests conducted under the following conditions.

1. Load: Resistive load
2. Mounting conditions: No vibration and no shock
3. Temperature: 20±2°C
4. Operating frequency: 20 operations/min

Super-bright LED

Rated voltage	Rated current	Operating voltage	Internal limiting resistor
5 VDC	30 mA (red: 15 mA)	5 VDC±5%	33 Ω (blue: 51 Ω, red: 68 Ω)
12 VDC	15 mA	12 VDC±5%	270 Ω (blue: 270 Ω, red: 560 Ω)
24 VDC	10 mA	24 VDC±5%	1600 Ω (blue: 1.8 kΩ, red 2 kΩ)

Note: The values in parentheses are for models with blue or red Pushbuttons.

Incandescent Lamp

Rated voltage	Rated current	Operating voltage
6 VAC/VDC	60 mA	5 VAC/VDC
14 VAC/VDC	40 mA	12 VAC/VDC
28 VAC/VDC	24 mA	24 VAC/VDC

Characteristics

Item		Pushbutton Switch
Allowable operating frequency	Mechanical	Momentary operation: 120 operations/minute max. Alternate operation: 60 operations/minute max. (See note 1.)
	Electrical	20 operations/minute max. (See note 1.)
Insulation resistance		100 MΩ min. (at 500 VDC)
Dielectric strength		1,000 VAC, 50/60 Hz for 1 min between terminals of same polarity 2,000 VAC, 50/60 Hz for 1 min between terminals of different polarity and also between each terminal and ground 1,000 VAC, 50/60 Hz for 1 min between lamp terminals (See note 2.)
Vibration resistance	Malfunction	10 to 55 Hz, 1.5-mm double amplitude (malfunction within 1 ms)
Shock resistance	Destruction	500 m/s ²
	Malfunction	150 m/s ² max. (malfunction within 1 ms)
Durability	Mechanical	Momentary operation: 2,000,000 operations min. Alternate operation: 200,000 operations min. (See note 1.)
	Electrical	100,000 operations min. (See note 1.)
Ambient temperature		Operating: -10°C to 55°C (with no icing or condensation) Storage: -25°C to 65°C (with no icing or condensation)
Ambient humidity		Operating: 35% to 85%
Electric shock protection class		Class II
PTI (tracking characteristic)		175
Degree of contamination		3 (IEC947-5-1)
Weight		Approx. 10 g (in the case of a lighted DPDT switch with solder terminals)

- Note: 1. Set and reset constitute one operation.
2. With LED and incandescent lamp not mounted.

Screw-Less Clamp

Item		Screw-Less Clamp			
Recommended wire size		0.5 mm ² twisted wire or 0.8 mm-dia. solid wire			
Usable wires and tensile strength	Twisted wire	0.3 mm ²	0.5 mm ²	0.75 mm ²	1.25 mm ²
	Solid wire	0.5 mm dia.	0.8 mm dia.	1.0 mm dia.	---
	Tensile strength	10 N	20 N	30 N	40 N
Length of exposed wire		10 ±1 mm			

■ Operating Characteristics

Features	Type	Pushbutton Switch	
		IP40	Oil-resistant IP65
Operating force (OF) max.		4.41 N	4.91 N
Releasing force (RF) min.		0.29 N	
Total travel (TT)		Approx. 3 mm	
Pretravel (PT) max.		2.5 mm	
Lock stroke (LTA) min. (See note.)		0.5 mm	

Note: Lock stroke is only for alternate operation.

■ Contact Form

Name	Contact
DPDT	<p>The diagram shows a central common terminal (COM) connected to two normally closed (NC) terminals and two normally open (NO) terminals. The NC terminals are positioned above the COM terminal, and the NO terminals are positioned below it.</p>

Nomenclature

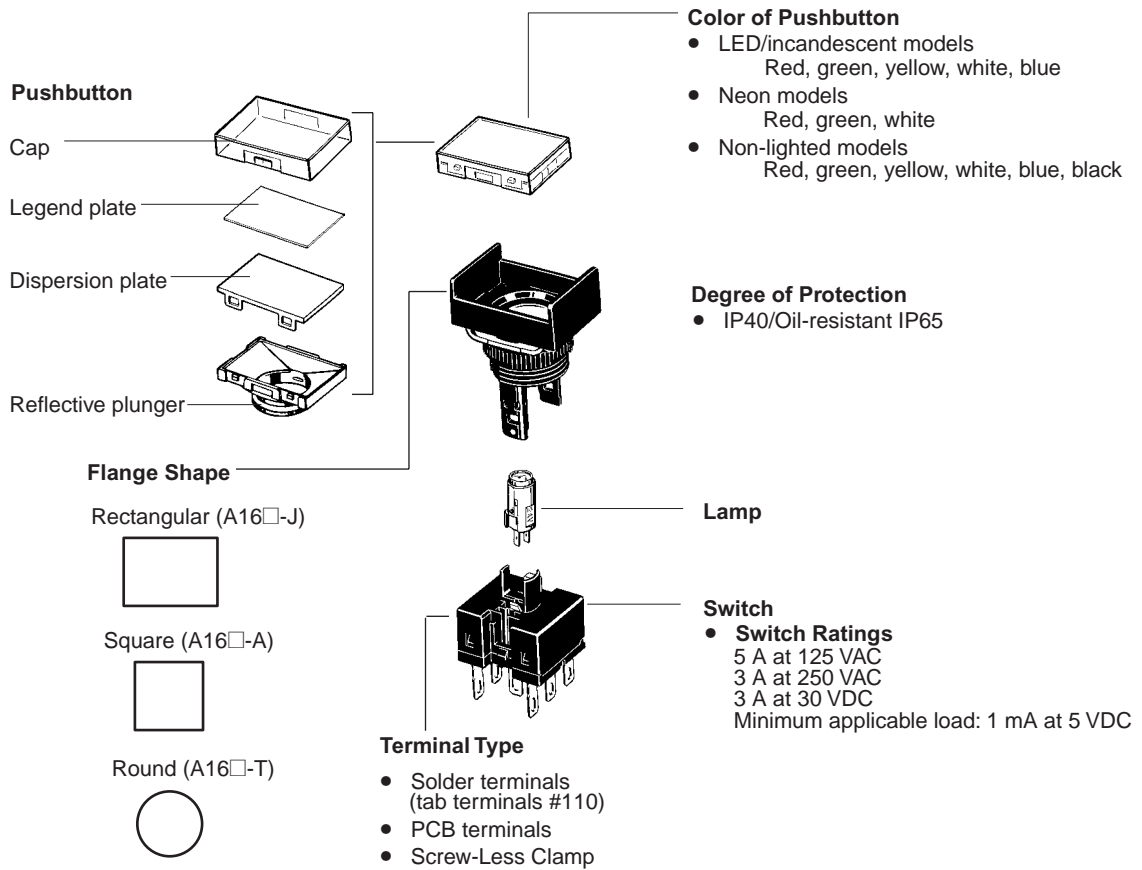

Dimensions

Note: All units are in millimeters unless otherwise indicated.

Lighted/Non-lighted Pushbutton Switches without Voltage Reduction Unit

The lamp terminal is also provided with non-lighted models.

Solder terminals and tab terminals (#110) can be both used with Lighted and Non-lighted Pushbutton Switches.

Rectangular

A16□-J

Solder terminals (tab terminals #110)

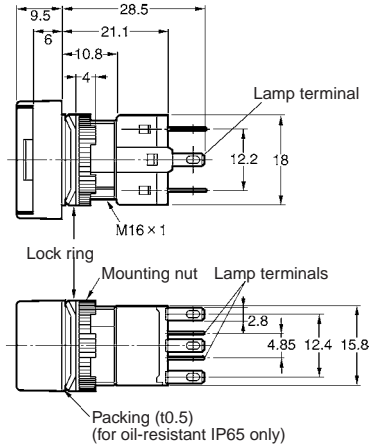
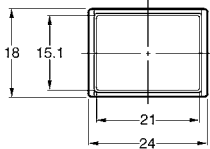
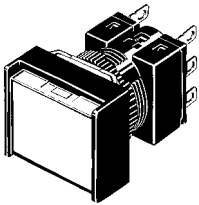

Panel Cutouts

See page 77 for panel cutouts

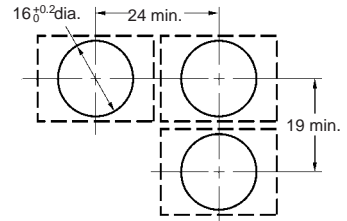

Square

A16□-A

Solder terminals (tab terminals #110)

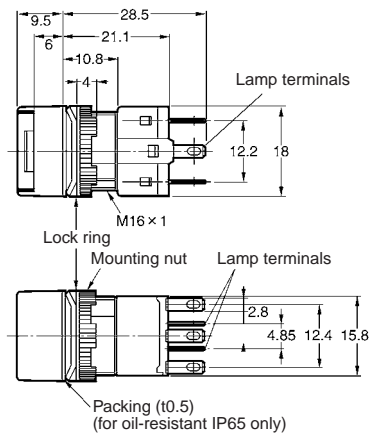
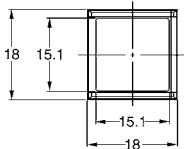
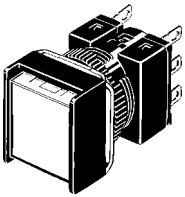

Panel Cutouts

See page 77 for panel cutouts

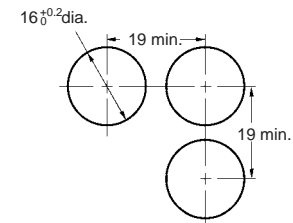

Round

A16□-T

Solder terminals (tab terminals #110)

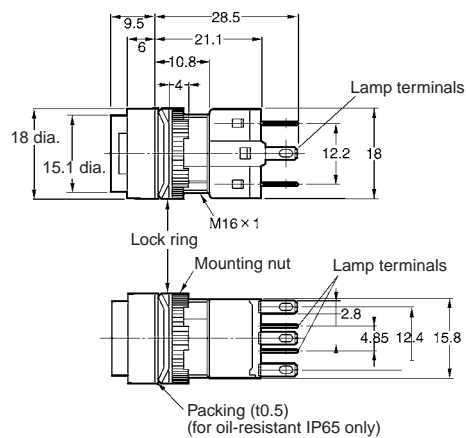
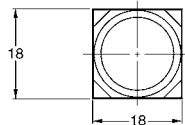
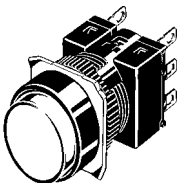

Panel Cutouts

See page 77 for panel cutouts

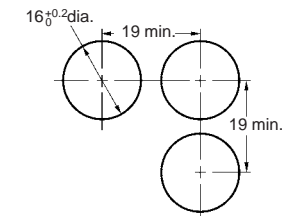

The following diagrams show the rectangular model as a representative example.

**Rectangular
A16□-J□-□P**
PCB terminals

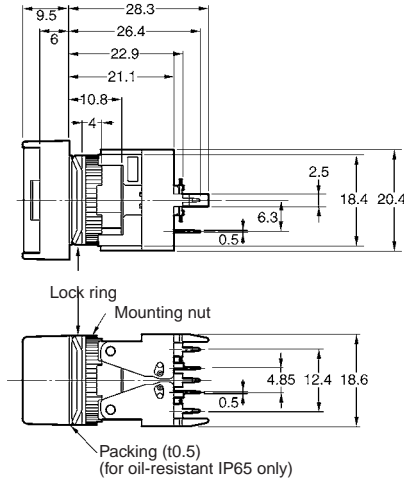
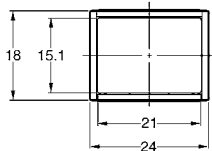
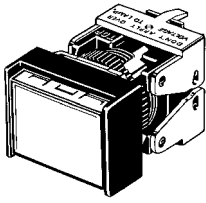

Panel Cutouts

See page 77 for panel cutouts

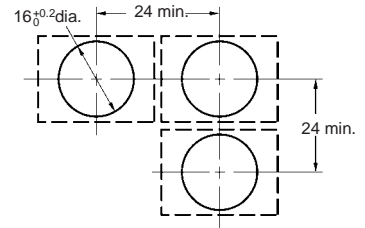

**Rectangular
A16□-J□-T1**
Voltage-reduction lighting,
solder terminals
(tab terminals #110)

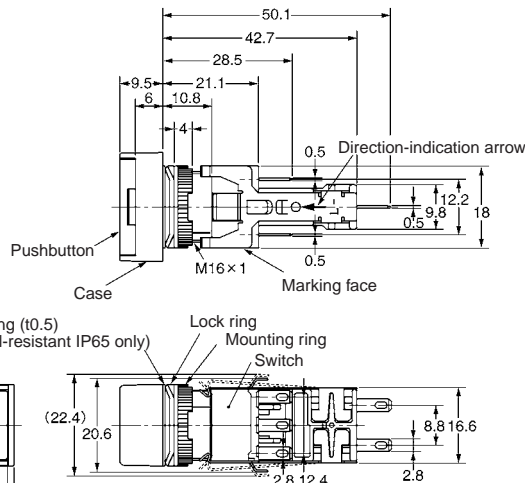
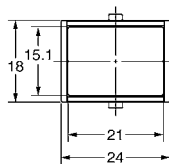
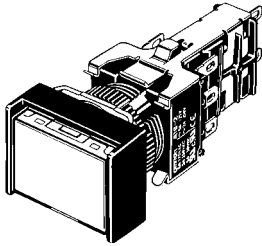

Panel Cutouts

See page 77 for panel cutouts

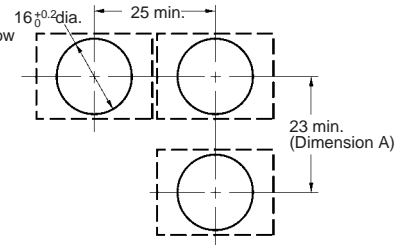

Recommended panel thickness: 0.5 to 3.2 mm

**Rectangular
A16□-J□-2S, T1-2S, T2-2S**
Screw-Less Clamp

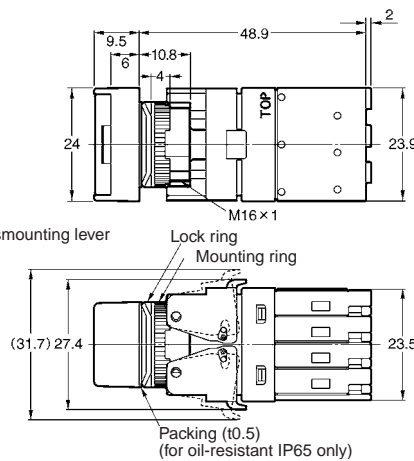
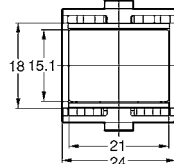
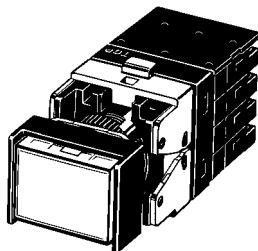

Panel Cutouts

See page 77 for panel cutouts

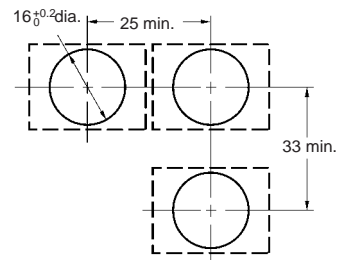

■ Lamps

LED
A16-5DS□/-12DS□/-24DS□

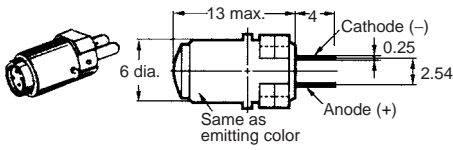

Incandescent Lamp
A16-5/-12/-24

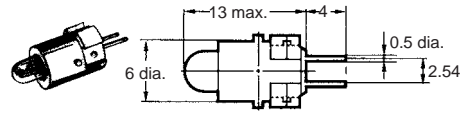

■ Accessories, Tools, and Components

Extractor
A3PJ-5080

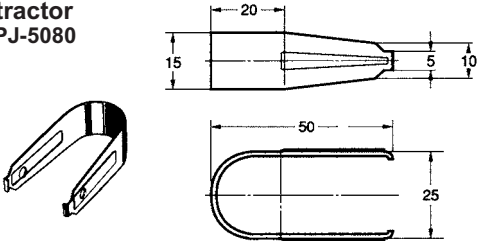

Legend Plates
A16ZJ-520□

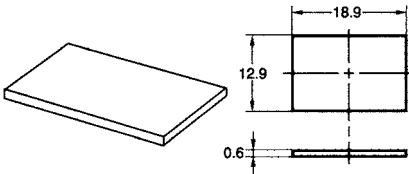

A16ZA-520□

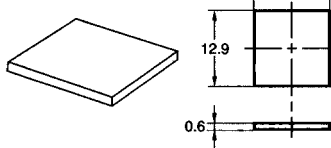

A16ZT-520□

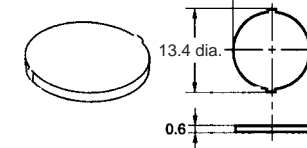

- Note:** 1. The panel is 0.6 mm thick.
2. The panel is made of the materials listed in the following table.

Color	Degree of protection	Materials
Milky	IP40	Polyallylate resin
	IP65	
Transparent	IP40	Polycarbonate resin
	IP65	Polyallylate resin

Note: The standard model is transparent.

Screw Fitting
A16Z-3004

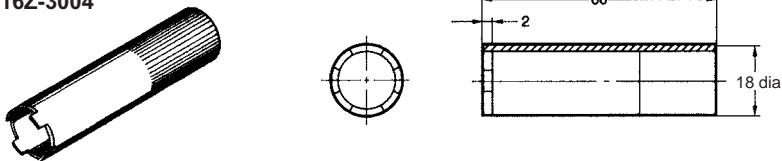

Panel Plugs (Black Resin)

Select the Plug that fits the panel design and mount from the front of the Panel. Panel cutouts are the same as those for Switches.
Protective structure: IP40

Rectangular
A16ZJ-3003

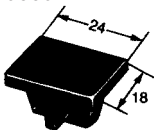

Square
A16ZA-3003

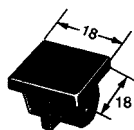

Round
A16ZT-3003



Lock Ring

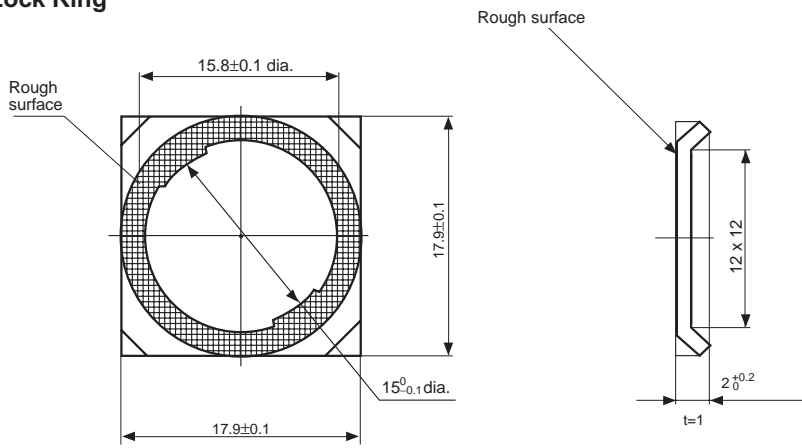

**Extractor
A16Z-5080**

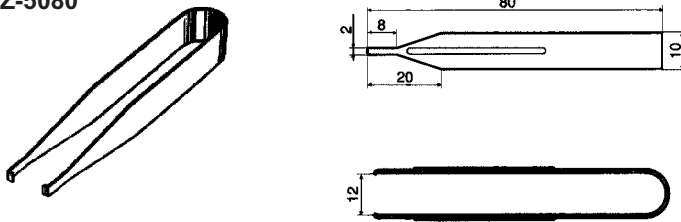

■ Dimensions with Accessories

Switch Guards

Rectangular A16ZJ-5050

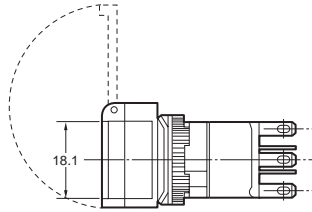
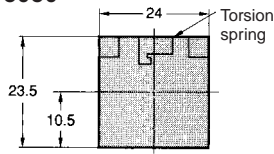

Panel Cutouts (Top View)

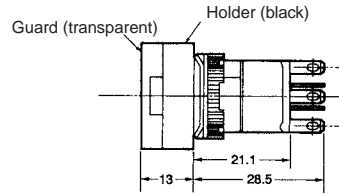
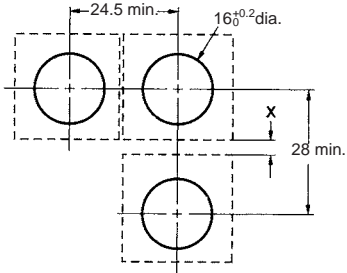

Note: The above illustration shows the case where 4.5 mm is provided for the distance "x." If no clearance is required for the "x" section, the vertical mounting dimension can be as small as 24 mm. Set this distance according to operating conditions.

Square A16ZA-5050

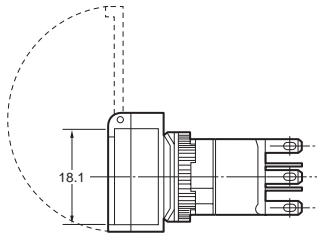
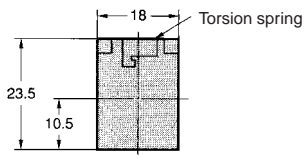

Panel Cutouts (Top View)

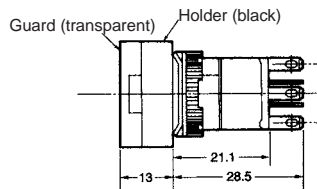
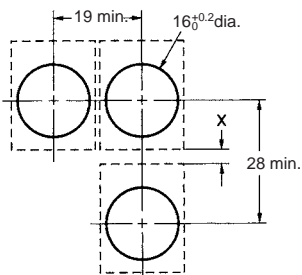

Note: The above illustration shows the case where 4.5 mm is provided for the distance "x." If no clearance is required for the "x" section, the vertical mounting dimension can be as small as 24 mm. Set this distance according to operating conditions. For models with PCB terminals, the horizontal mounting dimension is 24 mm min.

Dust Covers

Rectangular A16ZJ-5060

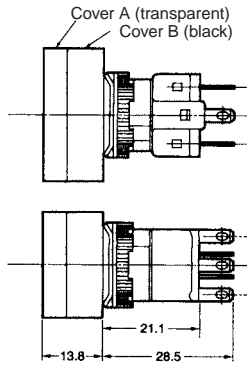
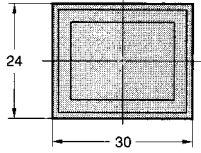

Panel Cutouts

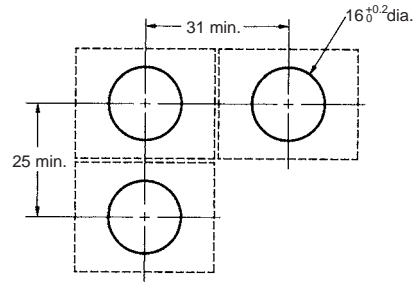

Square A16ZA-5060

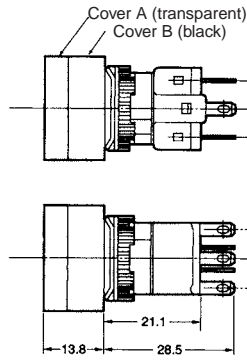
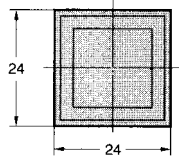

Panel Cutouts

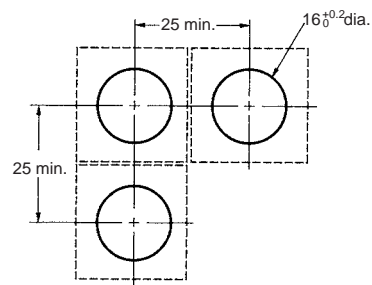

Round A16ZT-5060

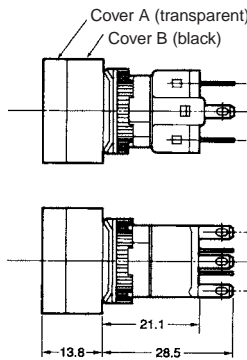
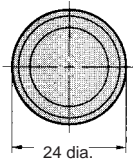

Panel Cutouts

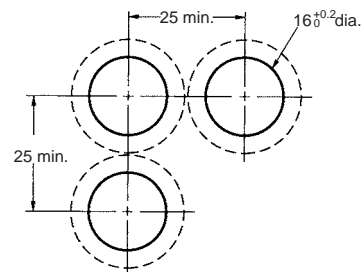

Terminal Arrangement

Models without Reduced-voltage Lighting

Non-lighted Pushbutton Switches are also provided with lamp terminals.

Solder Terminals

Lighted SPDT Switches

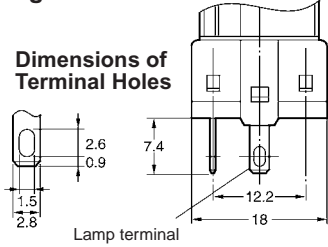

Terminal Arrangement (Bottom View)

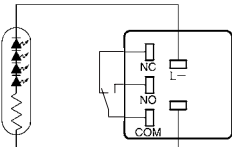

Note: The L+ is not shown on the Switch.

Lighted DPDT Switches

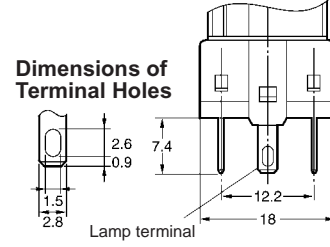

Terminal Arrangement (Bottom View)

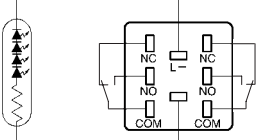

Note: The L+ is not shown on the Switch.

PCB Terminals

Lighted SPDT Switches

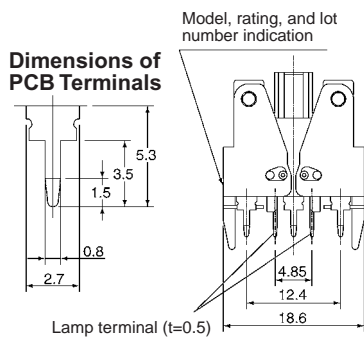

Terminal Arrangement (Bottom View)

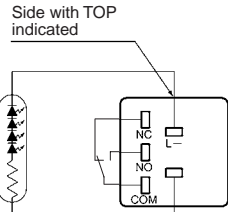

PCB Cutouts (Bottom View)

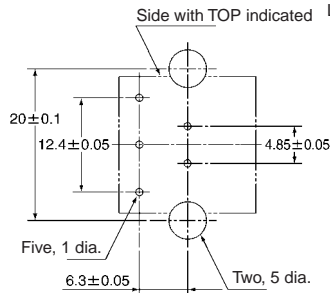

Lighted DPDT Switches

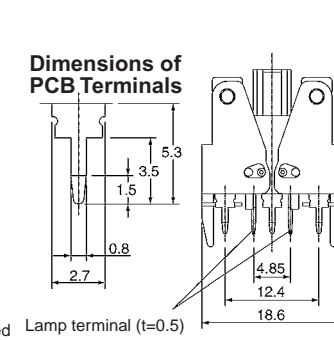

Terminal Arrangement (Bottom View)

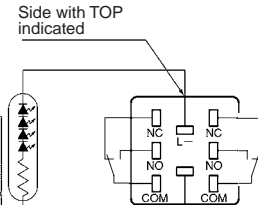

PCB Cutouts (Bottom View)

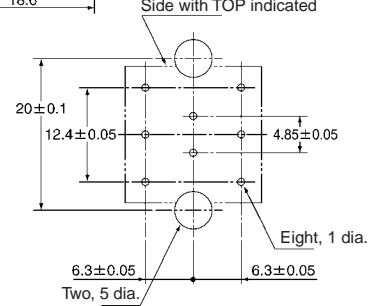

Voltage Reduction Units

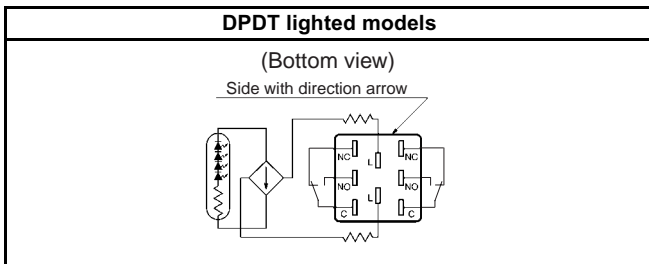

- The voltage-reduction circuit is built in.

Screw-Less Clamps

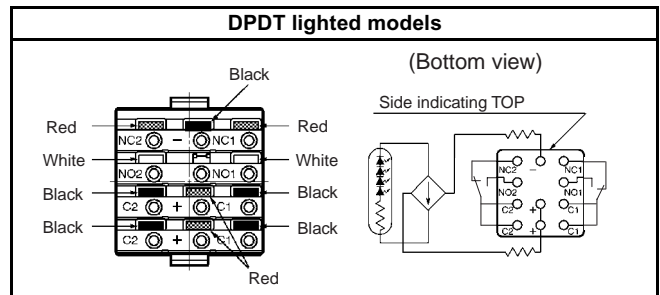

- Voltage-reduction lighting models with Screw-Less Clamps (A16L-□T1-2S, A16L-□T2-2S) incorporate voltage-reduction circuits.

■ Panel Cutouts

Solder Terminals

**Rectangular A16□-J/M16□-□J
(Top View)**

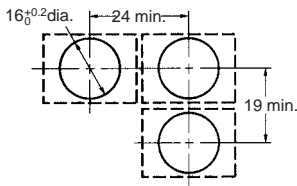

**Square A16□-A/M16□-A
Round A16□-T/M16□-T
(Top View)**

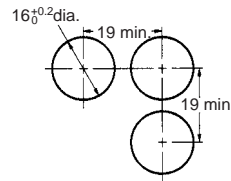

- Note:**
1. Make sure the thickness of the mounting panel is between 0.5 and 3.2 mm. If, however, a Switch Guard or Dust Cover is used, the thickness of the mounting panel must be between 0.5 and 2 mm.
 2. If the panel is to be finished with coating, etc., make sure that the panel meets the specified dimensions after coating.

PCB Terminals

**Rectangular A16□-J/M16□-J
(Top View)**

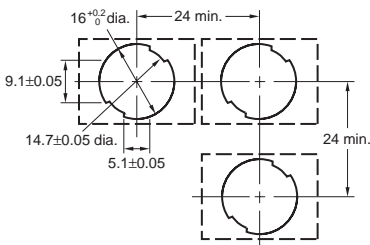

**Square A16□-A/M16□-A
Round A16□-T/M16□-T
(Top View)**

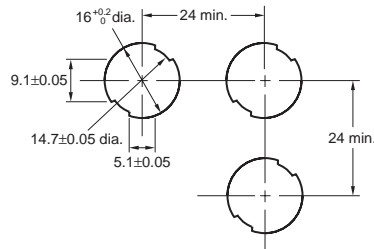

- Note:**
1. Ensure that the variation in the distance between the centers of neighboring mounting holes is less than ± 0.1 mm.
 2. Make sure the thickness of the mounting panel is between 0.5 and 3.2 mm. If, however, a Switch Guard or Dust Cover is used, the thickness of the mounting panel must be between 0.5 and 2 mm.
 3. If the panel is to be finished with coating, etc., make sure that the panel meets the specified dimensions after coating.

Installation

■ Panel Mounting

After mounting the Pushbutton Unit (i.e., the Pushbutton and the Case) to the panel, snap in the Switch Unit (i.e., the Switch and the Lamp) from the back of the panel.

Mounting to the Panel

Insert the Pushbutton Unit into the front of the panel, and fix the lock ring and mounting nut from the terminal side.

Make sure that the lock ring is aligned with the thread of the Case and the edge of the lock ring is touching the panel.

Tighten the mounting nuts to a torque of 0.29 to 0.49 N·m.

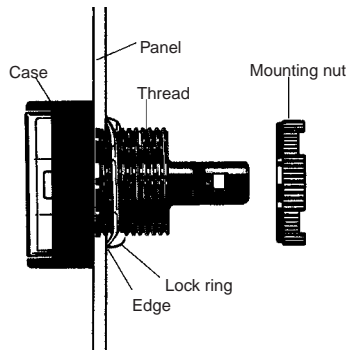

Mounting the Switch Unit

Snap on the Switch Unit to the Pushbutton Unit.

Make sure that the Switch Unit has the correct orientation when snapping it onto the Case. Align the • mark on the Case with the groove between the case guards on the NC terminal side of the Switch Unit in the way shown below, and push the Switch Unit into the Case until it clicks into place. Confirm that the Switch Unit is securely in place before using.

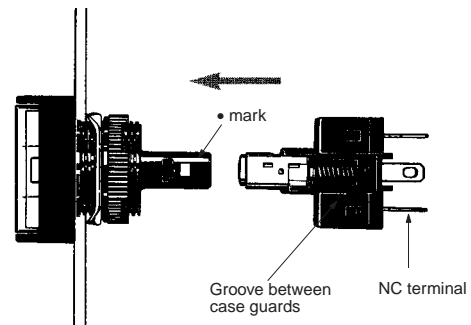

Mounting the Switch Unit for Voltage Reduction Types

1. The mounting panel thickness must be 0.5 to 3.2 mm.
2. The mounting ring must be tightened to a torque 0.29 to 0.49 N·m.
3. The mounting hole must be cut out in the way described previously. The dimension A is the length required for removing the Switch when it is in the mounted state. If Switches are mounted side-by-side separated by less than the specified distance, it may not be possible to remove the Switch.
4. Be sure to mount the Case to the Switch with the correct orientation. Mount with the • mark on the Case facing in the same direction as the side of the Switch with the direction arrow or the word TOP.

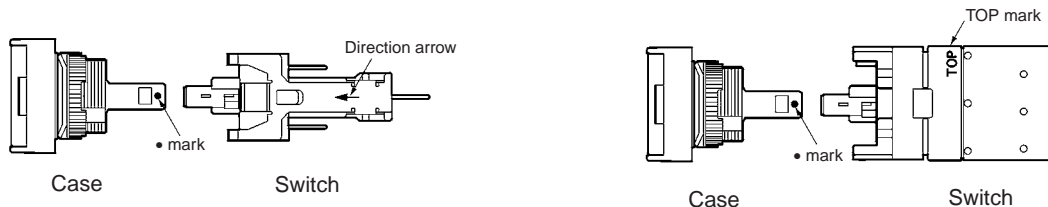

Removing the Switch Unit

Grip the part between the Switch holder of the Case and the Switch Unit using the A16Z-5080 Extractor, and pull to remove the Switch Unit.

- 16-mm Models

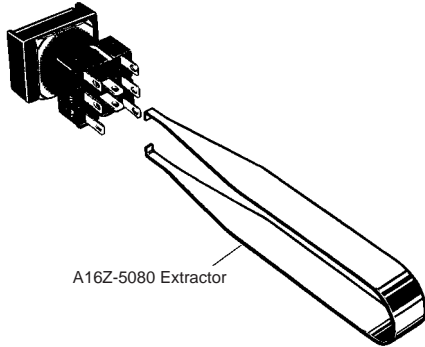

- A16-P Models (with PCB Terminals)

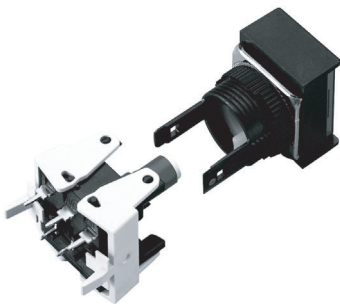

The Switch Unit can be mounted or dismounted by simply opening or closing the lever.

■ Mounting and Replacing the Pushbutton

Removing and Mounting the Pushbutton

1. Remove the Pushbutton as shown in the following diagram. If the Pushbutton cannot be removed by hand, use the A3PJ-5080 Extractor.

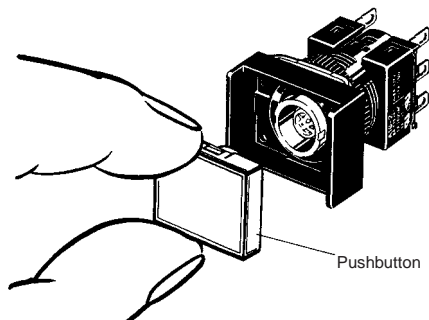

2. To attach the Pushbutton, push until it clicks into place.

Removing the Lamp

Removing from the Pushbutton End

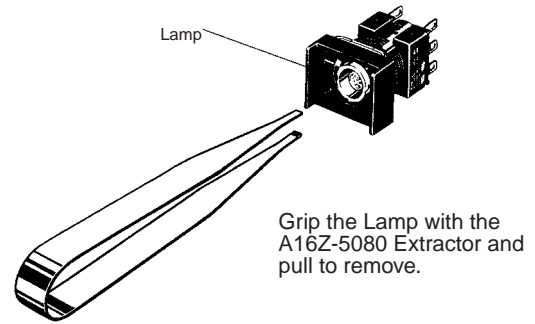

Removing from the Switch End

The Lamp can be removed by hand once the Switch is removed using the A16Z-5080 Extractor.

Installing the Lamp

When mounting the Lamp, make sure it is facing the direction shown in the following diagram. Insert the Lamp while matching the protruding part of the Lamp and the small guides on the outer surface of the Case.

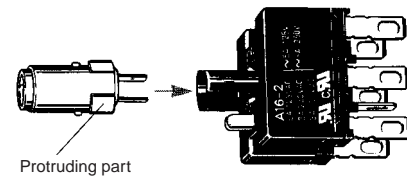

The Lamp can be mounted from the Pushbutton end by using the A16Z-5080 Extractor. The lamp can be mounted by following the opposite procedure for removing the Lamp.

■ Mounting the A16Z Dust Cover

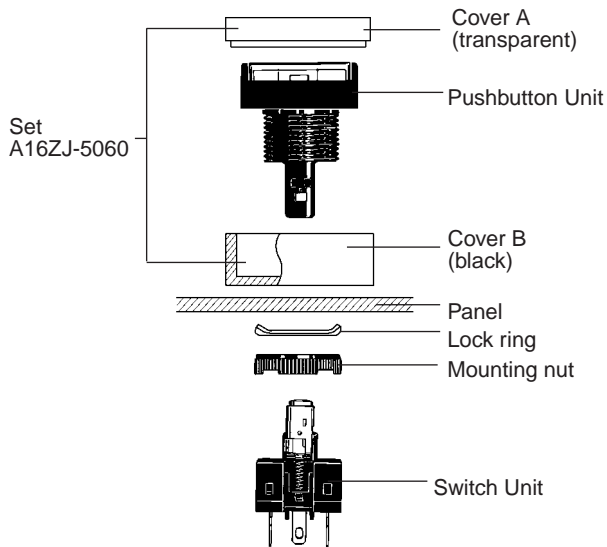

1. Separate the Dust Cover into 2 parts: cover A and cover B.
2. Insert the Case (Pushbutton Unit) into cover B.
3. Mount these parts together onto the panel.
4. From the back of the panel, mount the lock ring and secure with the mounting nut.
5. Insert cover A into cover B. Ensure that the entire perimeter of cover A is securely attached to cover B by pressing in different directions.
6. Mount the Switch Unit to the Case.

Note: Recommended panel thickness: 0.5 to 2 mm.

■ Mounting the A16Z Switch Guard

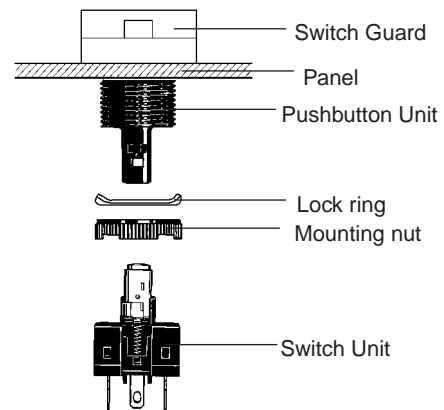

1. Insert the Case (Pushbutton Unit) into the Switch Guard.
2. Mount these parts together onto the panel.
3. From the back of the panel, mount the lock ring and secure with the mounting nut.
4. Attach the Switch Unit to the Case.

Note: Recommended panel thickness: 0.5 to 2 mm.

Precautions

Refer to the *Technical Information for Pushbutton Switches* (Cat. No. A143).

⚠ WARNING

Do not apply a voltage between the incandescent lamp and the terminal that is greater than the rated voltage. If the incandescent lamp is broken, the operating part may pop out.

Always turn OFF the power and wait for 10 minutes before replacing the incandescent lamp. If the lamp is replaced immediately after the power is turned OFF, the remaining heat may cause burns.

Correct Use

Mounting

Always make sure that the power is turned OFF before mounting, removing, or wiring the Switch, or performing maintenance.

Do not tighten the mounting nut more than necessary using tools such as pointed-nose pliers. Doing so will damage the mounting nut. The tightening torque is 0.29 to 0.49 N·m.

Wiring

Solder Terminal

Solder terminals and quick-connect terminals (#110) are commonly used for terminals.

Be sure to use electrical wires that are a size appropriate for the applied voltage and carry current (conductor size is 0.5 to 0.75 mm²). Perform soldering according to the conditions provided below. If the soldering is not properly performed, the lead wires will become detached, resulting in short-circuits.

1. Hand soldering: 30 W, within 5 s
2. Dip soldering: 240°C, within 3 s

Wait for one minute after soldering before exerting any external force on the solder.

Use non-corrosive resin fluid as the flux.

Make sure that the electric cord is wired so that it does not touch the Unit. If the electric cord touches the Unit, then electric wires with a heat resistance of 100°C min. must be used.

After wiring the Switch, maintain an appropriate clearance and creepage distance.

Screw-Less Clamps

Mounting Procedure

1. Strip a length of 10 mm off the end of the wire (allowable range: 10±1 mm).
2. Bunch wire strands together and straighten them.
3. Insert the wire into the insertion hole while pressing the release button at the side of the hole. (Using a precision screwdriver is recommended.)
4. Let go of the release button to lock the wire into place.
5. After locking, pull on the wire gently to confirm that it is securely locked.

Removing Procedure

Remove wires by pulling them while pressing the release button.

Note: When reusing wires that have already been locked, cut off the end of the wire and strip the wire again before using.

Operating Environment

The IP65 model is designed with a degree of protection so that it will not sustain damage if it is subjected to water from any direction to the front of the panel.

Using the Microload

Insert a contact protection circuit, if necessary, to prevent the reduction of life expectancy due to extreme wear on the contacts caused by loads where inrush current occurs when the contact is opened and closed.

The A16 allows both a standard load (125 V at 5A, 250 V at 3 A) and a microload. If a standard load is applied, however, the microload area cannot be used. If the microload area is used with a standard load, the contact surface will become rough, and the opening and closing of the contact for a microload may become unreliable.

The minimum applicable load is the N-level reference value. This value indicates the malfunction reference level for the reliability level of 60% (λ 60) (conforming to JIS C5003).

The equation, λ 60 = 0.5×10^{-4} /operations indicates that the estimated malfunction rate is less than 1/2,000,000 operations with a reliability level of 60%.

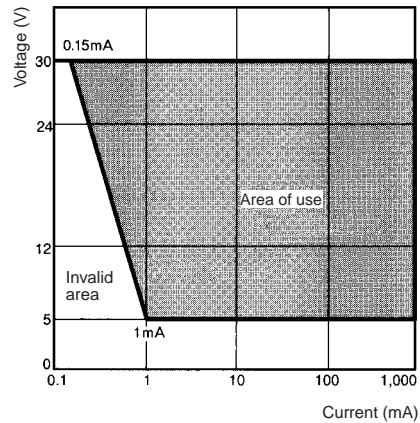

LED

The LED current-limiting resistor is built-in, so external resistance is not required.

Rated voltage	Internal limiting resistor
5 VDC	33 Ω (blue: 51 Ω, red: 68 Ω)
12 VDC	270 Ω (blue: 270 Ω, red: 560 Ω)
24 VDC	1600 Ω (blue: 1.8 kΩ, red: 2 kΩ)

Note: The values in parentheses are for models with blue or red Pushbutton Units.

Others

The oil-resistant IP65 uses NBR rubber and is resistant to general cutting oil and cooling oil. Some particular oils cannot be used with the oil-resistant IP65, however, so contact your OMRON representative for details.

If the panel is to be finished with coating, etc., make sure that the panel meets the specified dimensions after the coating.

Do not subject the Switch to extreme shock or vibration. Doing so will cause malfunctions and damage to the Switch.

Do not let sharp objects come into contact with the Switches that are made of resin. Doing so will damage the Switches, causing scratches on the outside of the operating parts, and malfunction.

When handling the Switches, do not throw or drop them.

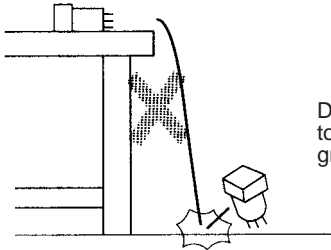

Do not allow the Switch to drop and hit the ground.

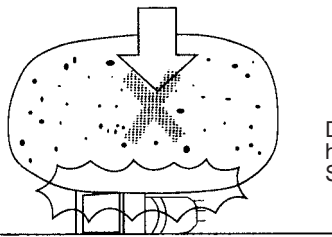

Do not place or drop heavy objects on the Switch.

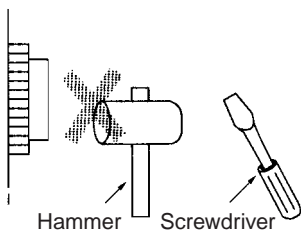

Do not operate the Switch with hard or sharp objects.

ALL DIMENSIONS SHOWN ARE IN MILLIMETERS.
To convert millimeters into inches, multiply by 0.03937. To convert grams into ounces, multiply by 0.03527.

Knob-type Selector Switch A165S/W

Mounting Aperture of 16 mm

- Modular construction
- Oil-resistant IP65 models
- UL and cUL approved.
- Conforms to EN60947-5-1, IEC947-5-1
- Short mounting depth, less than 28.5 mm below panel
- Wide range of switching capacity from standard to microload
- Lighted and non-lighted models
- 2 and 3-notch models
- Manual and automatic reset models

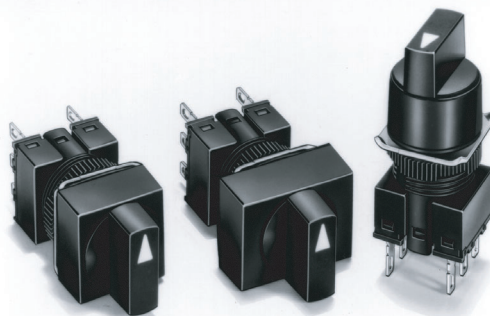

Model Number Structure

Model Number Legend

Completely Assembled

The model numbers used to order sets of Units are illustrated below. One set comprises the Selector, Lamp (lighted models only), and Switch.

A
1
6
5
W
-
A
2
A
R
-
2
4
D
-
1

(1) Lighted/Non-lighted

Symbol	Type
S	Non-lighted
W	Lighted

(2) Shape of Selector

Symbol	Shape
J	Rectangular
A	Square
T	Round

(3) Number of Notches/Resetting Method

Symbol	No. of notches	Reset method
2M	2 notches	Manual <input type="checkbox"/>
		Automatic <input type="checkbox"/>
3M	3 notches	Manual <input type="checkbox"/>
		Automatic <input type="checkbox"/>

(4) Color of Selector

Symbol	Color
No symbol	Black (non-lighted models only)
R	Red
G	Green
Y	Yellow

(6) Contact Configuration

Symbol	Type	Terminal
1	SPDT	Solder terminal
2	DPDT	
1P	SPDT	PCB terminal
2P	DPDT	
2S	DPDT	Screw-Less Clamp

Note:

1. Only DPDT contacts are available with 3-notch models and Screw-Less Clamp models.
2. PCB terminals are available only with 2-notch models.

(5) Light Source

Symbol	Type
No symbol	Non-lighted
24D	24 V-LED

Voltage Reduction Unit (24-V Built-in LED)

Symbol	Type	Operating voltage	Rated voltage
T1	LED	90 to 121 VAC/VDC	110 VAC/VDC
T2		180 to 242 VAC/VDC	220 VAC/VDC

Note:

1. Solder terminals are only available with 100-V models.
2. The Voltage Reduction Unit is not available for models with PCB terminals.

Subassembled

1. Selector

A165-□-□□□
1 2 3 4

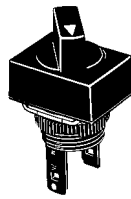

1. Lighted/Non-lighted

S: Non-lighted
W: Lighted

2. Flange Shape

J: Rectangular
A: Square
T: Round

3. Number of Notches/Reset Method

2M: 2 notches/Manual
2A: 2 notches/Automatic
3M: 3 notches/Manual
3A: 3 notches/Mixed-operation

4. Illumination Color

None: Black (Non-lighted models only)
R: Red
G: Green
Y: Yellow

2. Switch (Same as for Key-type Selector Switches)

A16S-□-□□□
1 2 3 4

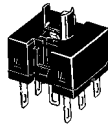

1. Number of Notches

2N: 2 notches
3N: 3 notches

2. Contacts

1: SPDT
2: DPDT

3. Lighted/Non-lighted

None: Non-lighted
L: Lighted

4. Terminals

None: Solder terminals (tab terminals #110)

3. Lamp

A16-□□
1 2



1. Operating Voltage (Rated Voltage)

LED

5DS: 5 VDC (5 VDC)
12DS: 12 VDC (12 VDC)
24DS: 24 VDC (24 VDC)

2. Illumination Color

R: Red (LED)
G: Green (LED)
Y: Yellow (LED)

Ordering Information

List of Models

Ordering as a Set

The model numbers used to order sets of Units are given in the following tables. One set comprises the Selector, Lamp (lighted models only), and Switch.

Solder Terminals

A165□-J (Rectangular) Models

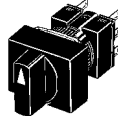

IP65 Oil-resistant

No. of notches	Output	Reset method	Lighting method	Operating voltage	Model
2 notches	SPDT	Manual	LED	24 VDC	A165W-J2M□-24D-1
			Non-lighted	---	A165S-J2M-1
		Automatic	LED	24 VDC	A165W-J2A□-24D-1
			Non-lighted	---	A165S-J2A-1
	DPDT	Manual	LED	24 VDC	A165W-J2M□-24D-2
			Non-lighted	---	A165S-J2M-2
Automatic	LED	24 VDC	A165W-J2A□-24D-2		
	Non-lighted	---	A165S-J2A-2		
3 notches	DPDT	Manual	LED	24 VDC	A165W-J3M□-24D-2
			Non-lighted	---	A165S-J3M-2

Note: Enter the desired color symbol for the Selector in □: R (red); Y (yellow); G (green). The Selector for non-lighted models is black.

A165□-A (Square) Models

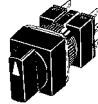

IP65 Oil-resistant

No. of notches	Output	Reset method	Lighting method	Operating voltage	Model
2 notches	SPDT	Manual	LED	24 VDC	A165W-A2M□-24D-1
			Non-lighted	---	A165S-A2M-1
		Automatic	LED	24 VDC	A165W-A2A□-24D-1
			Non-lighted	---	A165S-A2A-1
	DPDT	Manual	LED	24 VDC	A165W-A2M□-24D-2
			Non-lighted	---	A165S-A2M-2
Automatic	LED	24 VDC	A165W-A2A□-24D-2		
	Non-lighted	---	A165S-A2A-2		
3 notches	DPDT	Manual	LED	24 VDC	A165W-A3M□-24D-2
			Non-lighted	---	A165S-A3M-2

Note: Enter the desired color symbol for the Selector in □: R (red); Y (yellow); G (green). The Selector for non-lighted models is black.

A165□-T (Round) Models

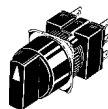

IP65 Oil-resistant

No. of notches	Output	Reset method	Lighting method	Operating voltage	Model
2 notches	SPDT	Manual ∨	LED	24 VDC	A165W-T2M□-24D-1
			Non-lighted	---	A165S-T2M-1
		Automatic ∩	LED	24 VDC	A165W-T2A□-24D-1
			Non-lighted	---	A165S-T2A-1
	DPDT	Manual ∨	LED	24 VDC	A165W-T2M□-24D-2
			Non-lighted	---	A165S-T2M-2
Automatic ∩	LED	24 VDC	A165W-T2A□-24D-2		
	Non-lighted	---	A165S-T2A-2		
3 notches	DPDT	Manual ∨	LED	24 VDC	A165W-T3M□-24D-2
			Non-lighted	---	A165S-T3M-2







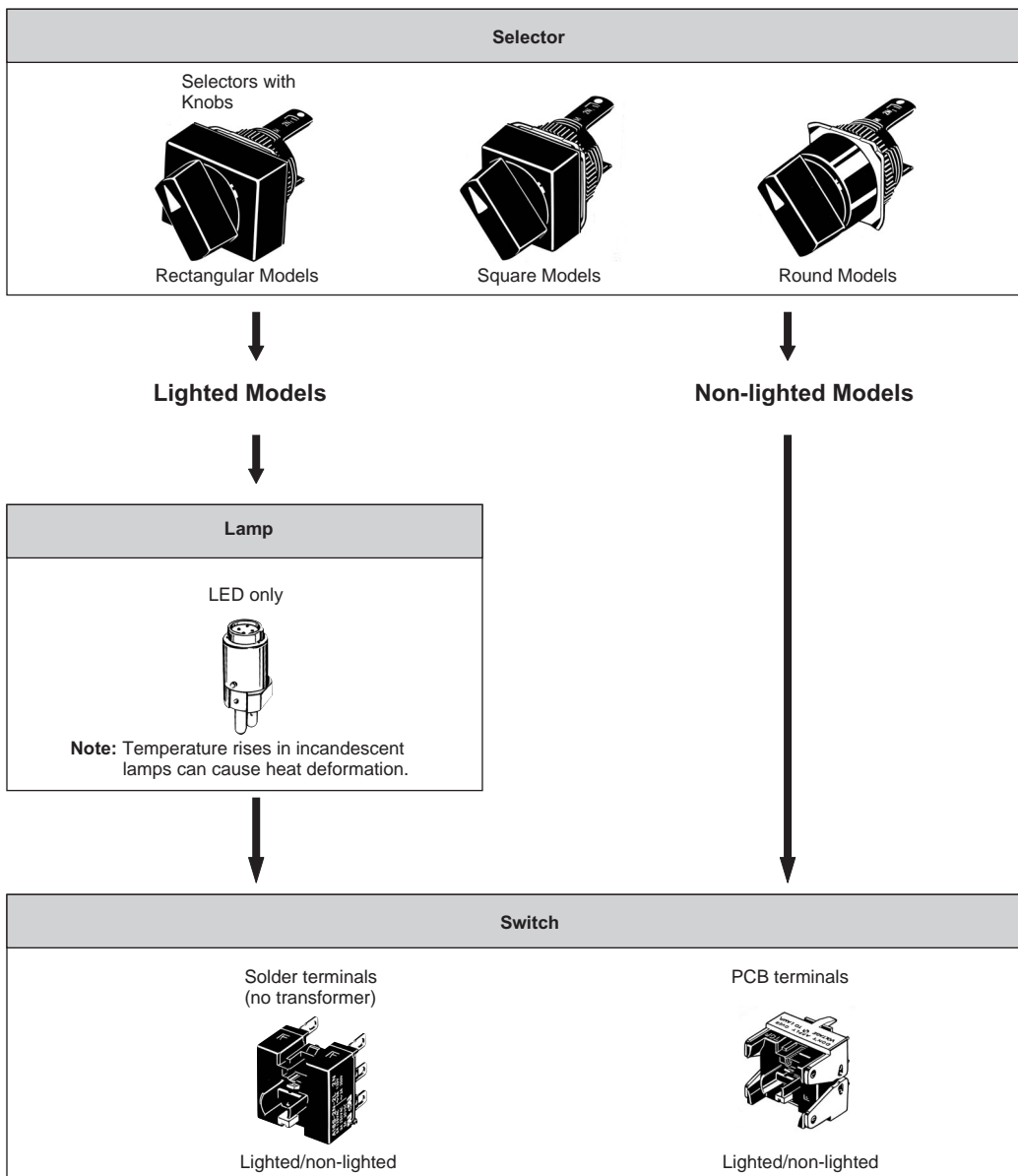

Note: Enter the desired color symbol for the Selector in □: R (red); Y (yellow); G (green). The Selector for non-lighted models is black.

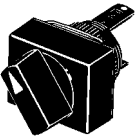
Ordering Individually

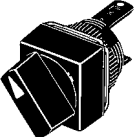
Selectors, Lamps, and Switches (Sockets) can be ordered separately. Combinations that are not available as sets can be created using individual Units. Also, store the parts as spares for maintenance and repairs.



Selectors (Oil-resistant IP65 Models Only)

Appearance	Number of notches	Reset method	Lighting method	Operating voltage	Model	Selector color symbol
Rectangular (A165□-J) 	2 notches	Manual	LED	24 VDC	A165W-J2M□	R (red), Y (yellow), G (green)
			Non-lighted	---	A165S-J2M	
	3 notches	Automatic 	LED	24 VDC	A165W-J2A□	
			Non-lighted	---	A165S-J2A	
		Fully automatic 	LED	24 VDC	A165W-J3M□	
			Non-lighted	---	A165S-J3M	
Square (A165□-A) 	2 notches	Manual	LED	24 VDC	A165W-A2M□	R (red), Y (yellow), G (green)
			Non-lighted	---	A165S-A2M	
	3 notches	Automatic 	LED	24 VDC	A165W-A2A□	
			Non-lighted	---	A165S-A2A	
		Fully automatic 	LED	24 VDC	A165W-A3M□	
			Non-lighted	---	A165S-A3M	
Round (A165□-T) 	2 notches	Manual	LED	24 VDC	A165W-T2M□	R (red), Y (yellow), G (green)
			Non-lighted	---	A165S-T2M	
	3 notches	Automatic 	LED	24 VDC	A165W-T2A□	
			Non-lighted	---	A165S-T2A	
		Fully automatic 	LED	24 VDC	A165W-T3M□	
			Non-lighted	---	A165S-T3M	

Note: 1. Enter the desired color symbol for the Selector in the □.
 2. The selector for non-lighted models is black.

Switches

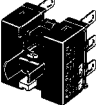
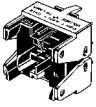
Appearance	Classification				Model	
	Lighted	Socket (without voltage-reduction lighting)	2 notches	SPDT	Solder terminal	A16S-2N-1L
				DPDT		A16S-2N-2L
			3 notches	DPDT		A16S-3N-2L
	2 notches			SPDT		A16S-2N-1
			DPDT	A16S-2N-2		
			3 notches	DPDT		A16S-3N-2
	Lighted		2 notches	SPDT	PCB terminal	A16S-2N-1LP
				DPDT		A16S-2N-2LP
			Non-lighted	SPDT		A16S-2N-1P
	2 notches			DPDT		A16S-2N-2P
				3 notches		DPDT

Lamps

LED

Operating voltage	5 VDC	12 VDC	24 VDC
 Light color			
Red	A16-5DSR	A16-12DSR	A16-24DSR
Yellow	A16-5DSY	A16-12DSY	A16-24DSY
Green	A16-5DSG	A16-12DSG	A16-24DSG

Accessories (Order Separately)

Accessories

Name	Appearance	Classification	Model	Remarks
Panel Plugs		Rectangular	A16ZJ-3003	Used for covering the panel cutouts for future panel expansion. Degree of protection: IP40
		Square	A16ZA-3003	
		Round	A16ZT-3003	

Tools

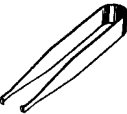
Name	Appearance	Model	Applicable types					Remarks
			Pushbutton Switch	Knob-type Selector Switch	Key-type Selector Switch	Emergency Stop Switch	Indicator	
Screw Fitting		A16Z-3004	Yes	Yes	Yes	Yes	Yes	Convenient for ganged installation. Tighten to a torque of 0.39 N·m min.
Extractor		A16Z-5080	Yes	Yes	Yes	Yes	Yes	Convenient for extracting the Switches and Lamps.

Specifications

Approved Standards

Agency	Standards	File No.
UL, cUL (See note.)	UL508	E41515
---	EN60947-5-1	---

Note: cUL: CSA, C22.2 No. 14

Approved Standard Ratings

UL, cUL (File No. E41515)

5 A at 125 VAC, 3 A at 250 VAC (general use)
3 A at 30 VDC (resistive)

EN60947-5-1 (Low Voltage Directive)

3 A at 250 VAC (AC12), 3 A at 30 VDC (DC12)

Ratings

Contacts

AC resistive load	DC resistive load
3 A at 250 VAC 5 A at 125 VAC	3 A at 30 VDC

Minimum applicable load: 1 mA at 5 VDC
Rated values are obtained from tests conducted under the following conditions.

1. Load: Resistive load
2. Mounting conditions: No vibration and no shock
3. Temperature: 20±2°C
4. Operating frequency: 20 times/min

Super-bright LED

Rated voltage	Rated current	Operating voltage	Internal limiting resistor
5 VDC	30 mA (15 mA)	5 VDC±5%	33 Ω (68 Ω)
12 VDC	15 mA	12 VDC±5%	270 Ω (560 Ω)
24 VDC	10 mA	24 VDC±5%	1600 Ω (2,000 Ω)

Note: The values in parentheses are for red Selectors.

■ Characteristics

Item		Knob-type Selector Switch
Allowable operating frequency	Mechanical	20 operations/minute max.
	Electrical	10 operations/minute max.
Insulation resistance		100 MΩ min. (at 500 VDC)
Dielectric strength		1,000 VAC, 50/60 Hz for 1 min between terminals of same polarity 2,000 VAC, 50/60 Hz for 1 min between terminals of different polarity and also between each terminal and ground 1,000 VAC, 50/60 Hz for 1 min between lamp terminals (See note.)
Vibration resistance	Malfunction	10 to 55 Hz, 1.5-mm double amplitude (malfunction within 1 ms)
Shock resistance	Destruction	500 m/s ²
	Malfunction	150 m/s ² max. (malfunction within 1 ms)
Durability	Mechanical	250,000 operations min.
	Electrical	100,000 operations min.
Ambient temperature		Operating: -10°C to 55°C (with no icing or condensation) Storage: -25°C to 65°C (with no icing or condensation)
Ambient humidity		Operating: 35% to 85%
Electric shock protection class		Class II
PTI (tracking characteristic)		175
Degree of contamination		3 (IEC947-5-1)
Weight		Approx. 13 g (in the case of a lighted DPDT switch)

Note: With LED not mounted.

Screw-less Clamp

Item		Screw-less Clamp			
Recommended wire size		0.5 mm ² twisted wire or 0.8 mm-dia. solid wire			
Usable wires and tensile strength	Twisted wire	0.3mm ²	0.5 mm ²	0.75 mm ²	1.25 mm ²
	Solid wire	0.5 mm dia.	0.8 mm dia.	1.0 mm dia.	---
	Tensile strength	10 N	20 N	30 N	40 N
Length of exposed wire		10 ±1 mm			

■ Operating Characteristics

Features	Type	Knob-type Selector Switch	
		2 notches	3 notches
Operating force (OF) max.	0.1 N·m		
Set position (SP)	90±5°	45 ^{+10°} ₀	

■ Operation Angle

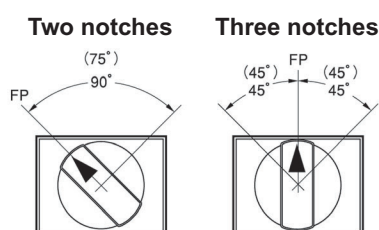





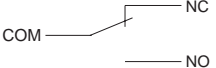

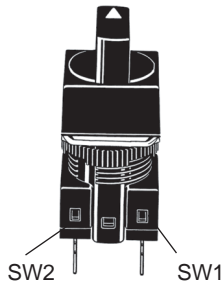











Note: 1. The angle used for automatic reset is shown in parentheses.
2. FP: Free Position

■ Contact Form

Name	Contact
SPDT	



Notch	Contact				
	SPDT		DPDT		
	Position	SW	Position	SW2	SW1
2 notches					
					
3 notches	---				
	---				
	---				

Nomenclature

Selector

Flange Shape

Rectangular (A165□-J)

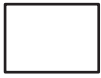

Square (A165□-A)



Round (A165□-T)



Protective Structure

- Oil-resistant IP65

Color of Selector

- LED models
Red, green, yellow
- Non-lighted models
Black

Lighting Method

- Lighted (LED) models
(The upper face of the knob is illuminated.)
- Non-lighted models

Number of Notches and Reset Method

- **2 Notches**
Manual reset
Automatic reset
- **3 Notches**
Manual reset
Automatic reset

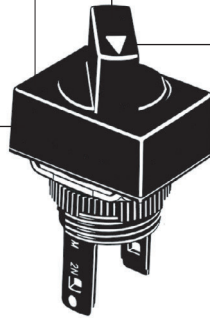

Lamp

Switch

Switch Specifications

- **Standard Loads**
5 A at 125 VAC
5 A at 250 VAC
3 A at 30 VDC
Minimum applicable load: 1 mA at 5 VDC

Terminal Type

- Solder terminals
(tab terminals #110)
- PCB terminals

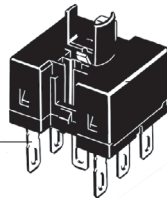

Dimensions

Note: All units are in millimeters unless otherwise indicated.

■ Knob-type Selector Switches without Voltage Reduction Unit

Rectangular A165□-J

Solder terminals (tab terminals #110)

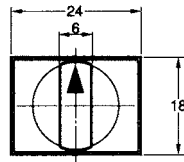
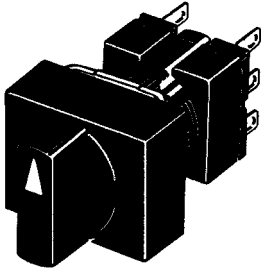

Note: See page 96 for panel cutouts.

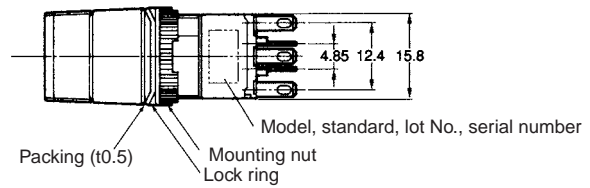
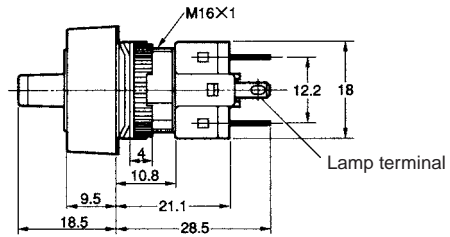

Square A165□-A

Solder terminals (tab terminals #110)

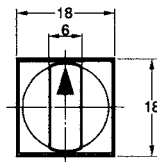
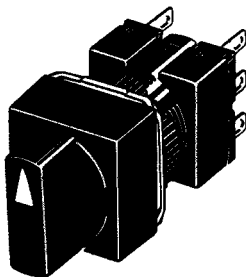

Note: See page 96 for panel cutouts.

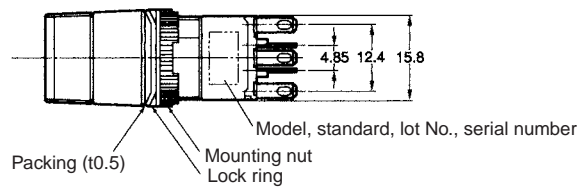
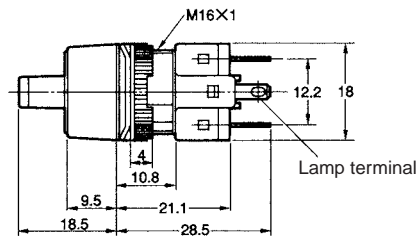

Round A165□-T

Solder terminals (tab terminals #110)

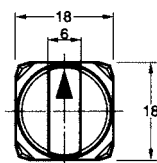
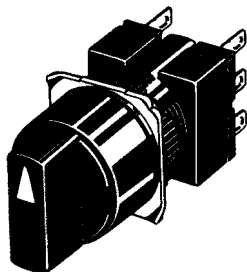

Note: See page 96 for panel cutouts.

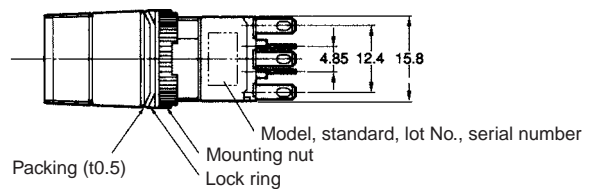
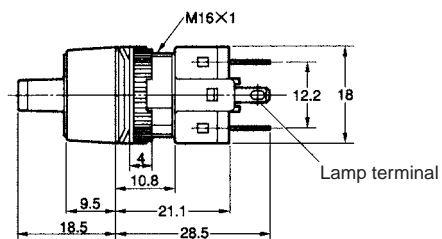

The following diagrams show the rectangular model as a representative example. The lamp terminal is also provided with non-lighted models.

**Rectangular
A165□-J**

PCB terminals

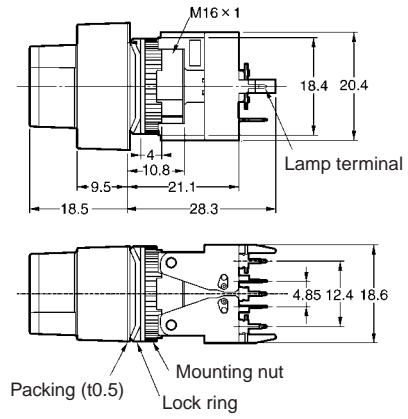
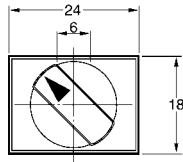
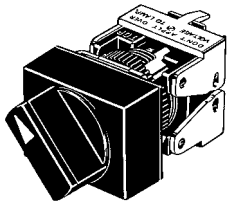

Note: See page 96 for panel cutouts.

**Rectangular
A165W□-T**

Reduced-voltage lighting, solder terminals (tab terminals #110)

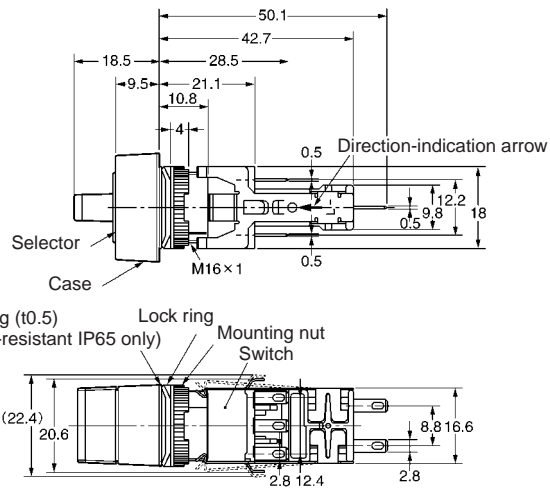
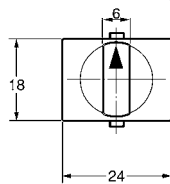
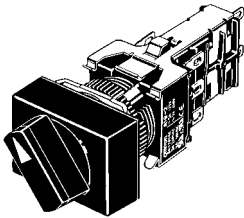

**Rectangular
A165□-2S**

Screw-Less Clamp

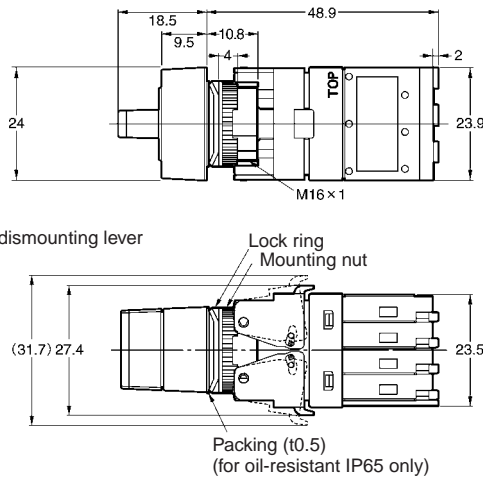
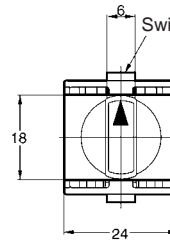
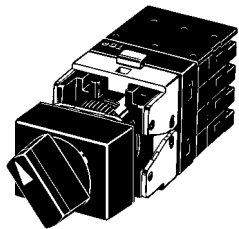

Terminal Arrangement

Models with Solder Terminals without Reduced-voltage Lighting

Lamp terminals are not provided with the Non-lighted Knob-type Selector Switches and Key-type Selector Switches.

Lighted SPDT Switches

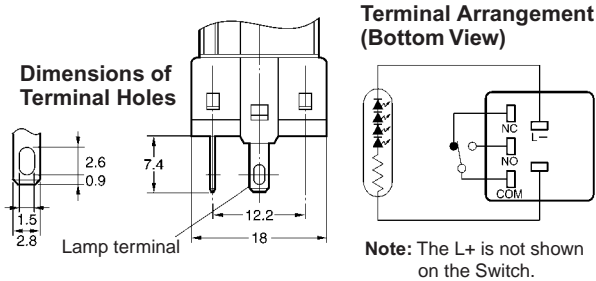

Lighted DPDT Switches

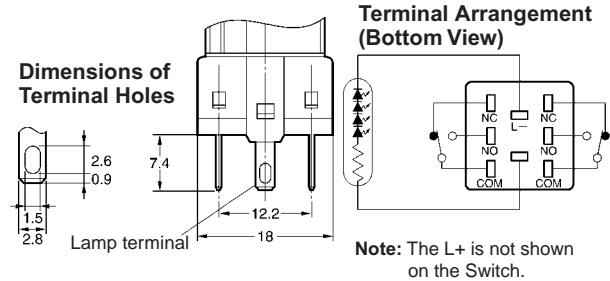

Non-lighted SPDT Switches

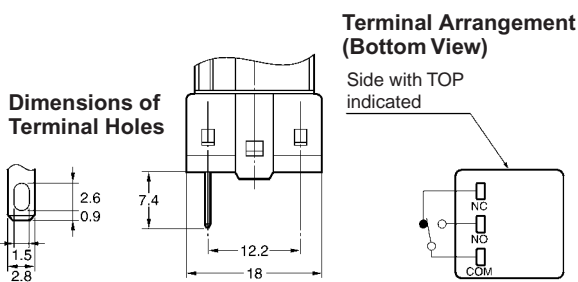

Non-lighted DPDT Switches

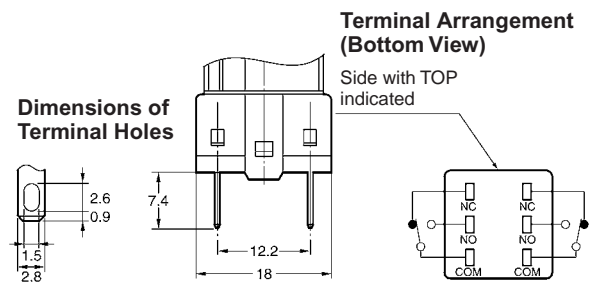

Models with PCB Terminals

Lighted SPDT Switches

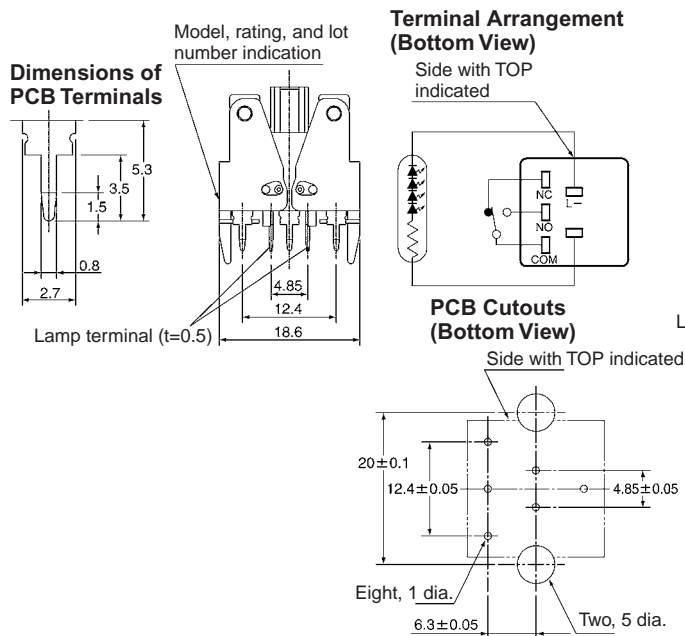

Lighted DPDT Switches

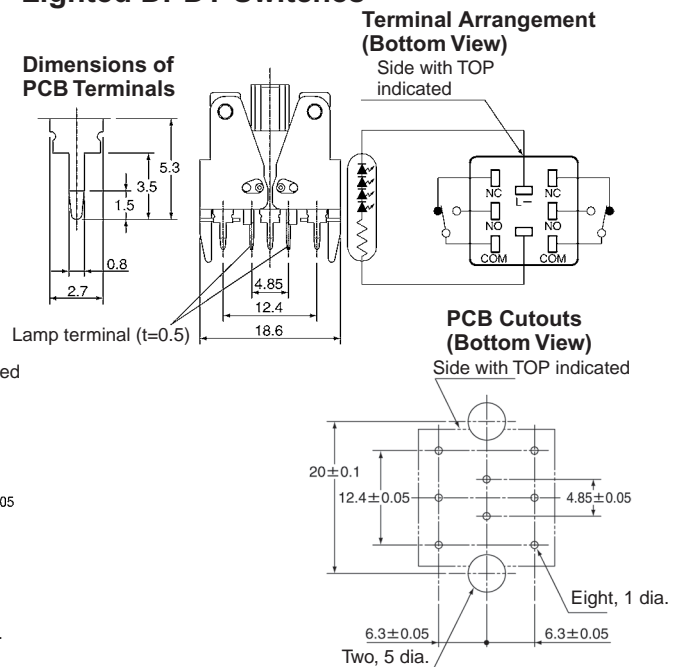

Note: For details of the terminal arrangement for Screw-Less Clamps, refer to the corresponding section for the A16.

Non-lighted Models with PCB Terminals

Lamp terminals are not provided with the Non-lighted Knob-type Selector Switches and Key-type Selector Switches.

Non-lighted SPDT Switches

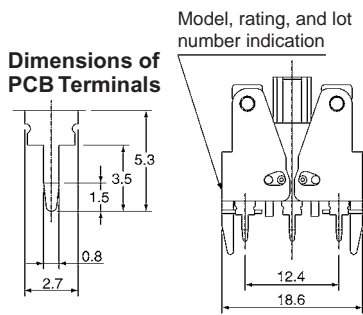

Terminal Arrangement (Bottom View)

Side with TOP indicated

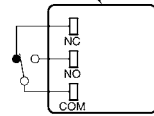

PCB Cutouts (Bottom View)

Side with TOP indicated

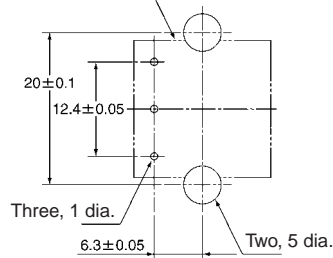

Non-lighted DPDT Switches

Dimensions of PCB Terminals

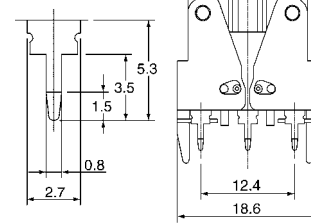

Side with TOP indicated

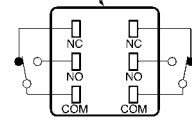

PCB Cutouts (Bottom View)

Side with TOP indicated

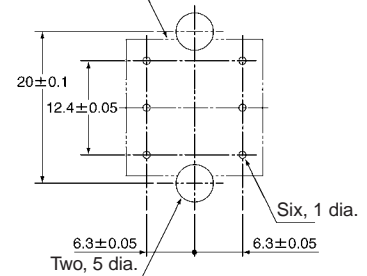

■ Panel Cutouts

Models with Solder Terminals

Rectangular A165□-J

(Top View)

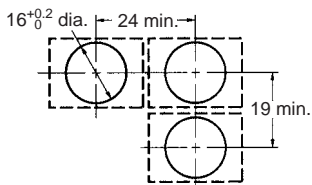

Square A165□-A Round A165□-T

(Top View)

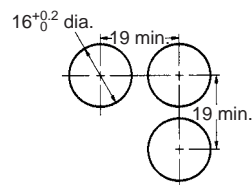

Note: 1. Make sure the thickness of the mounting panel is 0.5 to 3.2 mm.

2. If the panel is to be finished with coating, etc., make sure that the panel meets the specified dimensions after coating.

Models with PCB Terminals

Rectangular A165□-J (Top View)

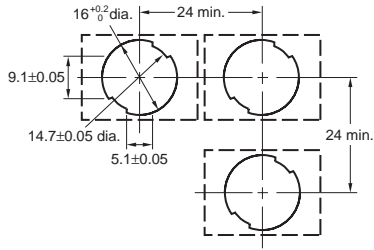

Square A165□-A Round A165□-T (Top View)

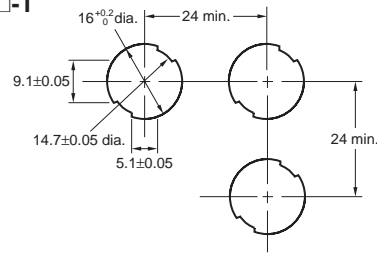

Rectangular A165W□-T

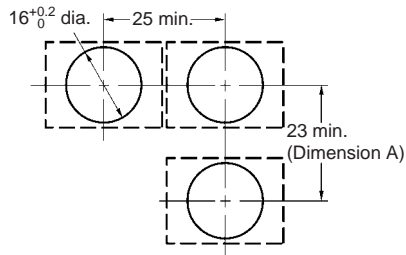

Recommended panel thickness: 0.5 to 3.2 mm

Rectangular A165□-2S

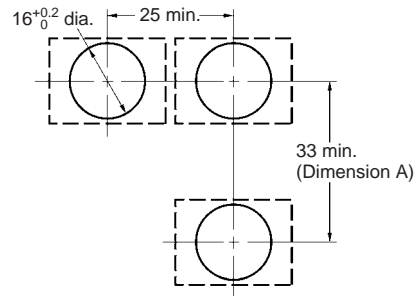

Recommended panel thickness: 0.5 to 3.2 mm

- Note:**
1. Ensure that the variation in the distance between the centers of neighboring mounting holes is less than ± 0.1 mm.
 2. Make sure the thickness of the mounting panel is 0.5 to 3.2 mm. If, however, a Switch Guard or Dust Cover is used, the thickness of the mounting panel must be 0.5 to 2 mm.
 3. If the panel is to be finished with coating, etc., make sure that the panel meets the specified dimensions after coating.

Installation

For details on mounting the Switch to a panel, and mounting and dismantling the Switch, refer to installation details for the A16 Pushbutton Switch.

■ Panel Mounting

Refer to the *Installation* section for the A16.

■ Mounting and Replacing the Pushbutton

Refer to the *Installation* section for the A16.

■ Flange Rotation

A165 Knob-type Selector Switch

Fix the Switch screw and rotate the flange in 45° turns.

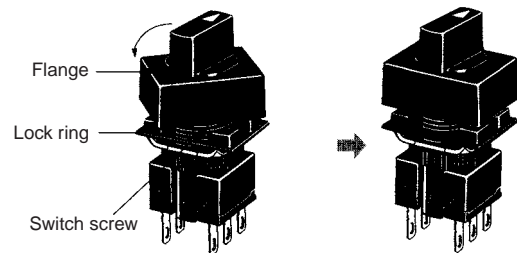

Precautions

Refer to the *Technical Information for Pushbutton Switches* (Cat. No. A143) and the *Precautions* section for the A16.

ALL DIMENSIONS SHOWN ARE IN MILLIMETERS.
To convert millimeters into inches, multiply by 0.03937. To convert grams into ounces, multiply by 0.03527.

Key-type Selector Switch A165K

Mounting Aperture of 16 mm

- Modular construction
- Oil-resistant IP65 models
- UL and cUL approved.
- Conforms to EN60947-5-1, IEC947-5-1
- Short mounting depth, less than 28.5 mm below panel
- Wide range of switching capacity from standard to microload
- Automatic and manual models available

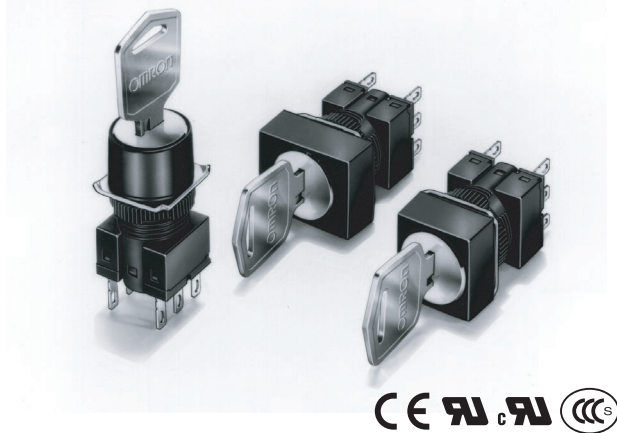

Model Number Structure

■ Model Number Legend

Completely Assembled

The model numbers used to order sets of Units are illustrated below. One set comprises the Selector, Switch, and 2 Keys.

(1) (2) (3)
A 1 6 5 K - J 3ML - 2

(1) Shape of Selector

Symbol	Shape	Color
J	Rectangular	Black
A	Square	
T	Round	

(2) Number of Notches/Resetting Method

Symbol	No. of notches	Reset method	Key release position
2ML	2 notches	Manual	Left
2MR			Right
2M		Left and right	
2AL	3 notches	Automatic	Left
3MC		Manual	Center
3MR			Right
3ML			Left
3M		Left, right, and center	
3AC	3 notches	Automatic	Center

(3) Contact Configuration

Symbol	Type	Terminal
1	SPDT	Solder Terminal
2	DPDT	Solder Terminal
2S	DPDT	Screw-Less Clamp

Note: 1. Only DPDT contacts are available with 3-notch models

2. PCB terminals are available only with 2-notch models.

Subassembled

1. Selector

A165K-□□
1 2



1. Flange Shape

- J: Rectangular
- A: Square
- T: Round

2. Number of Notches/Reset Method/Key Release Position

- 2ML: 2 notches/Manual/Left
- 2MR: 2 notches/Manual/Right
- 2M: 2 notches/Manual/Right and left
- 2AL: 2 notches/Automatic/Left
- 3MC: 3 notches/Manual/Center
- 3MR: 3 notches/Manual/Right
- 3ML: 3 notches/Manual/Left
- 3M: 3 notches/Manual/Right, left, and center
- 3AC: 3 notches/Automatic/Center

2. Switch (Same as for Knob-type Selector Switches)

A16S-□-□□
1 2 3

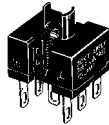

1. Number of Notches

- 2N: 2 notches
- 3N: 3 notches

2. Contacts

- 1: SPDT
- 2: DPDT

3. Terminals

None: Solder terminals (tab terminals #110)

Ordering Information

■ List of Models

Ordering as a Set

The model numbers used to order sets of Units are given in the following tables. One set comprises the Selector and Switch.

Solder Terminals

A165K-J (Rectangular) Models

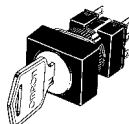

IP65 Oil-resistant

Number of notches	Output	Reset method	Key release position	Model
2 notches	SPDT	Manual	Left	A165K-J2ML-1
			Right	A165K-J2MR-1
			Left and right	A165K-J2M-1
		Automatic	Left	A165K-J2AL-1
	DPDT	Manual	Left	A165K-J2ML-2
			Right	A165K-J2MR-2
			Left and right	A165K-J2M-2
		Automatic	Left	A165K-J2AL-2
3 notches	DPDT	Manual	Center	A165K-J3MC-2
			Right	A165K-J3MR-2
			Left	A165K-J3ML-2
			Left, right, and center	A165K-J3M-2

A165K-A (Square) Models

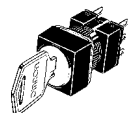

IP65 Oil-resistant

Number of notches	Output	Reset method	Key release position	Model
2 notches	SPDT	Manual	Left	A165K-A2ML-1
			Right	A165K-A2MR-1
			Left and right	A165K-A2M-1
		Automatic	Left	A165K-A2AL-1
	DPDT	Manual	Left	A165K-A2ML-2
			Right	A165K-A2MR-2
			Left and right	A165K-A2M-2
		Automatic	Left	A165K-A2AL-2
3 notches	DPDT	Manual	Center	A165K-A3MC-2
			Right	A165K-A3MR-2
			Left	A165K-A3ML-2
			Left, right, and center	A165K-A3M-2

A165K-T (Round) Models

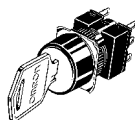











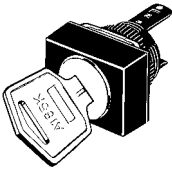











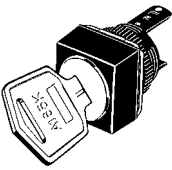







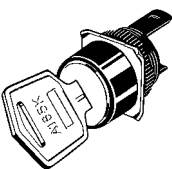

IP65 Oil-resistant

Number of notches	Output	Reset method	Key release position	Model
2 notches	SPDT	Manual	Left	A165K-T2ML-1
			Right	A165K-T2MR-1
			Left and right	A165K-T2M-1
		Automatic	Left	A165K-T2AL-1
	DPDT	Manual	Left	A165K-T2ML-2
			Right	A165K-T2MR-2
			Left and right	A165K-T2M-2
		Automatic	Left	A165K-T2AL-2
3 notches	DPDT	Manual	Center	A165K-T3MC-2
			Right	A165K-T3MR-2
			Left	A165K-T3ML-2
			Left, right, and center	A165K-T3M-2

Ordering Individually

Selectors and Switches can be ordered separately. Combinations that are not available as sets can be created using individual Units. Also, store the parts as spares for maintenance and repairs.

Selectors

Appearance	Number of notches	Reset method	Key release position	Model
Rectangular (A165K-J) 	2 notches	Manual		A165K-J2ML
				A165K-J2MR
				A165K-J2M
		Automatic 		A165K-J2AL
	3 notches	Manual		A165K-J3MC
				A165K-J3MR
				A165K-J3ML
				A165K-J3M
			Automatic 	
		Square (A165K-A) 	2 notches	Manual
	A165K-A2MR			
	A165K-A2M			
Automatic 				A165K-A2AL
3 notches	Manual			A165K-A3MC
				A165K-A3MR
				A165K-A3ML
				A165K-A3M
			Automatic 	
	Round (A165K-T) 		2 notches	Manual
		A165K-T2MR		
		A165K-T2M		
Automatic 				A165K-T2AL
3 notches		Manual		A165K-T3MC
				A165K-T3MR
				A165K-T3ML
				A165K-T3M
			Automatic 	

Switches

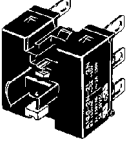
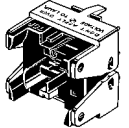
Appearance	Classification				Model
	Switch	2 notches	SPDT	Solder terminal	A16S-2N-1
			DPDT		A16S-2N-2
		3 notches	DPDT		A16S-3N-2
	Switch	2 notches	SPDT	PCB terminal	A16S-2N-1P
			DPDT		A16S-2N-2P

Switches with Screw-Less Clamp

Appearance	Classification			Model	Remarks	
	Common to general load and micro load.	DPDT	2 notches	Non-lighted	A16-2S	Common to ones for pushbutton switches.
			3 notches		A16S-3N-2LS	

Accessories (Order Separately)

Accessories

Name	Appearance	Classification	Model	Remarks
Panel Plugs		Rectangular	A16ZJ-3003	Used for covering the panel cutouts for future panel expansion. Degree of protection: IP40
		Square	A16ZA-3003	
		Round	A16ZT-3003	

Tools

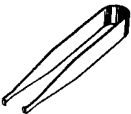
Name	Appearance	Model	Applicable types					Remarks
			Pushbutton Switch	Knob-type Selector Switch	Key-type Selector Switch	Emergency Stop Switch	Indicator	
Screw Fitting		A16Z-3004	Yes	Yes	Yes	Yes	Yes	Convenient for ganged installation. Tighten to a torque of 0.98 N·m
Extractor		A16Z-5080	Yes	Yes	Yes	Yes	Yes	Convenient for extracting the Switches and Lamps.

Key

Appearance	Model
	A165K-KEY

Note: Two Keys are provided.

Specifications

■ Approved Standards

Agency	Standards	File No.
UL, cUL (See note.)	UL508	E41515
---	EN60947-5-1	---

Note: cUL: CSA, C22.2 No. 14

■ Approved Standard Ratings

UL, cUL (File No. E41515)

5 A at 125 VAC, 3 A at 250 VAC (general use)
3 A at 30 VDC (resistive)

EN60947-5-1 (Low Voltage Directive)

3 A at 250 VAC (AC12), 3 A at 30 VDC (DC12)

■ Ratings

Contacts

AC resistive load	DC resistive load
3 A at 250 VAC 5 A at 125 VAC	3 A at 30 VDC

Minimum applicable load: 1 mA at 5 VDC
Rated values are obtained from tests conducted under the following conditions.

1. Load: Resistive load
2. Mounting conditions: No vibration and no shock
3. Temperature: 20±2°C
4. Operating frequency: 20 times/min

■ Characteristics

Item		Key-type Selector Switch
Allowable operating frequency	Mechanical	20 operations/minute max.
	Electrical	10 operations/minute max.
Insulation resistance		100 MΩ min. (at 500 VDC)
Dielectric strength		1,000 VAC, 50/60 Hz for 1 min between terminals of same polarity 2,000 VAC, 50/60 Hz for 1 min between terminals of different polarity and also between each terminal and ground
Vibration resistance	Malfunction	10 to 55 Hz, 1.5-mm double amplitude (malfunction within 1 ms)
Shock resistance	Destruction	500 m/s ²
	Malfunction	150 m/s ² max. (malfunction within 1 ms)
Durability	Mechanical	250,000 operations min. (durability of key: 10,000 operations min.)
	Electrical	100,000 operations min.
Ambient temperature		Operating: -10°C to 55°C (with no icing or condensation) Storage: -25°C to 65°C (with no icing or condensation)
Ambient humidity		Operating: 35% to 85%
Electric shock protection class		Class II
PTI (tracking characteristic)		175
Degree of contamination		3 (IEC947-5-1)
Weight		Approx. 26.5 g (in the case of a DPDT switch key)

Screw-less Clamp

Item		Screw-less Clamp			
Recommended wire size		0.5 mm ² twisted wire or 0.8 mm-dia. solid wire			
Usable wires and tensile strength	Twisted wire	0.3mm ²	0.5 mm ²	0.75 mm ²	1.25 mm ²
	Solid wire	0.5 mm dia.	0.8 mm dia.	1.0 mm dia.	---
	Tensile strength	10 N	20 N	30 N	40 N
Length of exposed wire		10 ±1 mm			

Operating Characteristics

Features	Type	Key-type Selector Switch	
		2 notches	3 notches
Operating force (OF) max.	0.1 N·m		
Set position (SP)	90±5°		45°+10/0

Operation Angle

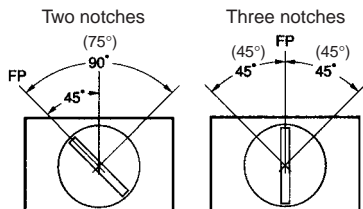

Note: The angle used for automatic reset is shown in parentheses.

Contact Form

Name	Contact
DPDT	

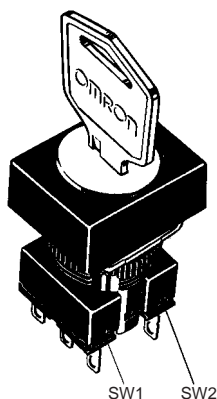

Notch	Contact				
	SPDT		DPDT		
	Position	SW	Position	SW1	SW2
2 notches					
3 notches	---				

Nomenclature

Selector

Flange Shape

Rectangular (A165K-J)



Square (A165K-A)



Round (A165K-T)



Protective Structure

- Oil-resistant IP65

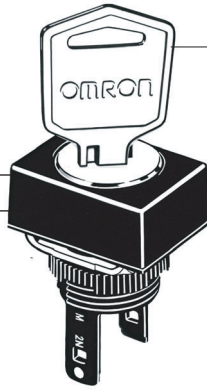

Key

Number of Notches and Reset Method

- **2 Notches**
 - Manual
 - Automatic
- **3 Notches**
 - Manual
 - Mixed-operation

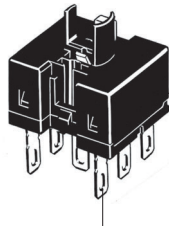

Switch

Switch Specifications

- **Standard Loads**
 - 5 A at 125 VAC
 - 3 A at 250 VAC
 - 3 A at 30 VDC
- Minimum applicable load: 1 mA at 5 VDC

Terminal Type

- Solder terminals (tab terminals #110)
- PCB terminals

Dimensions

Note: All units are in millimeters unless otherwise indicated.

Key-type Selector Switches

Rectangular A165K-J

Solder terminals (tab terminals #110)

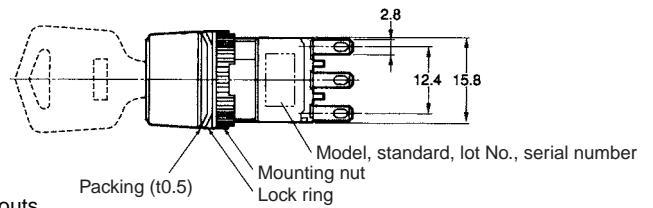
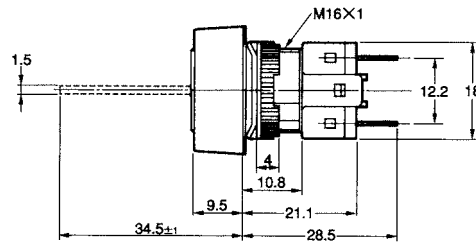
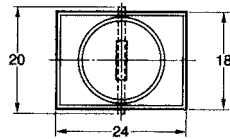
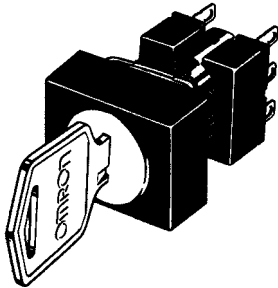

Note: See page 110 for panel cutouts.

Square A165K-A

Solder terminals (tab terminals #110)

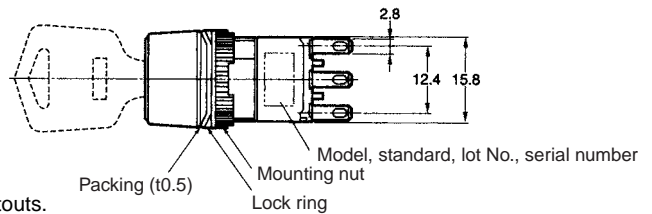
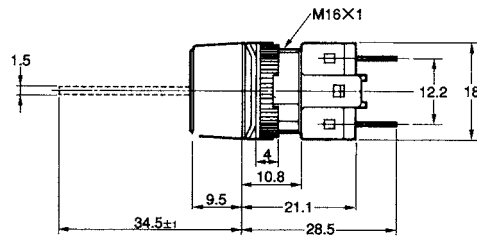
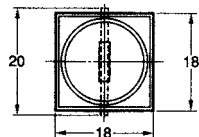
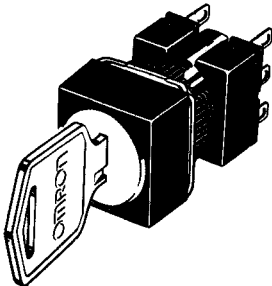

Note: See page 110 for panel cutouts.

Round A165K-T

Solder terminals (tab terminals #110)

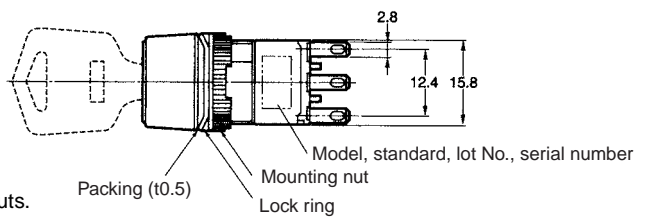
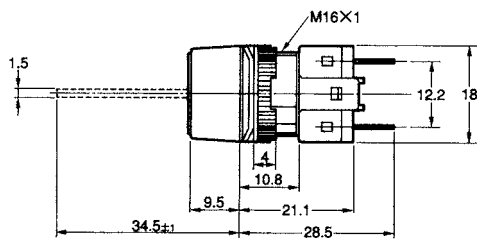
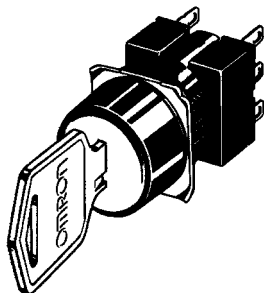

Note: See page 110 for panel cutouts.

The following diagrams show the rectangular model as a representative example.

**Rectangular
A165K-J**
PCB terminals

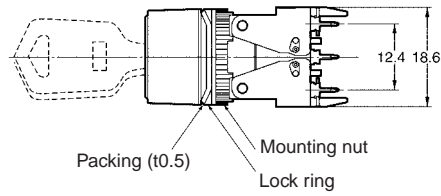
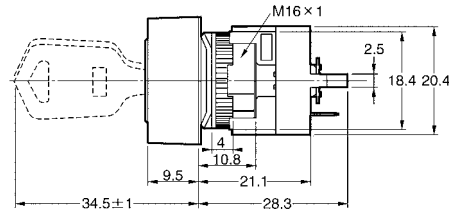
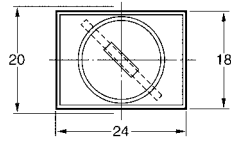
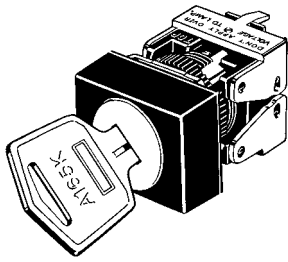

Note: See page 110 for panel cutouts.

**Rectangular
A165K□-2S**
Screw-Less Clamp

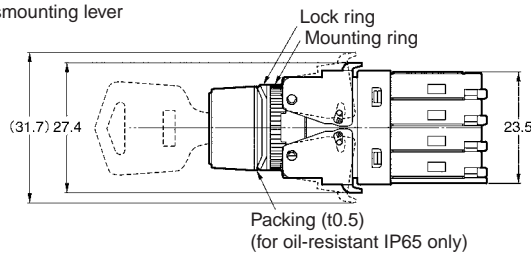
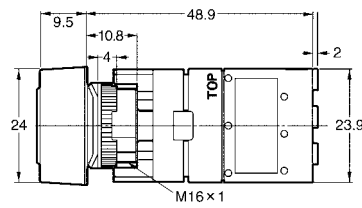
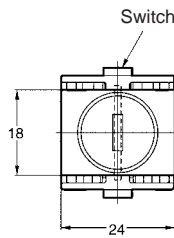
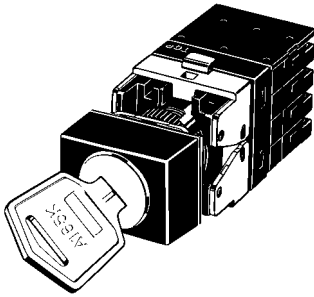

Terminal Arrangement

Models with Solder Terminals without Reduced-voltage Lighting

Lamp terminals are not provided with the Non-lighted Knob-type Selector Switches and Key-type Selector Switches.

Lighted SPDT Switches

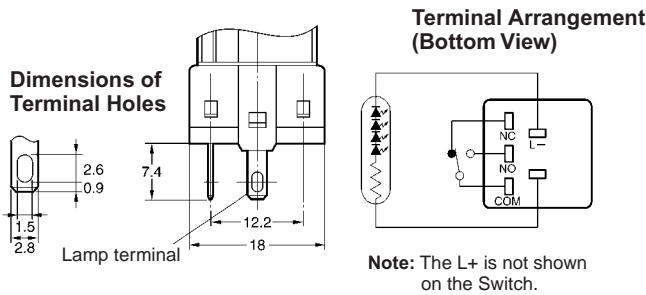

Lighted DPDT Switches

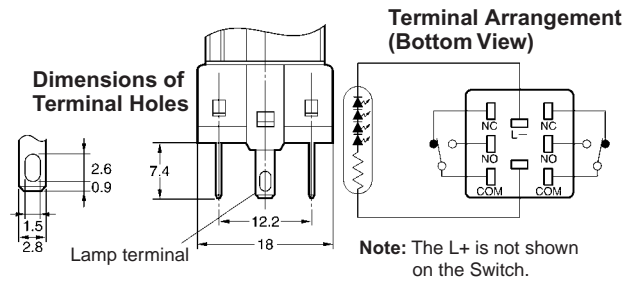

Non-lighted SPDT Switches

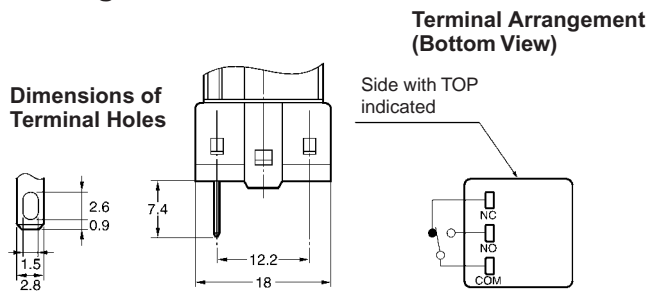

Non-lighted DPDT Switches

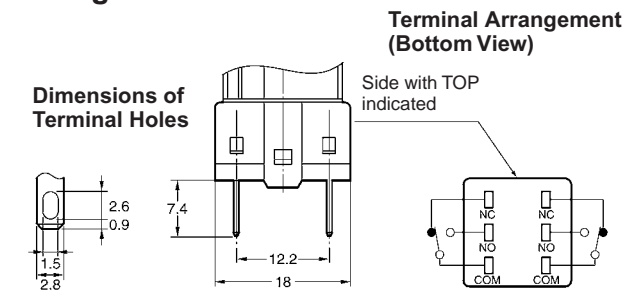

Lighted Models with PCB Terminals

Lighted SPDT Switches

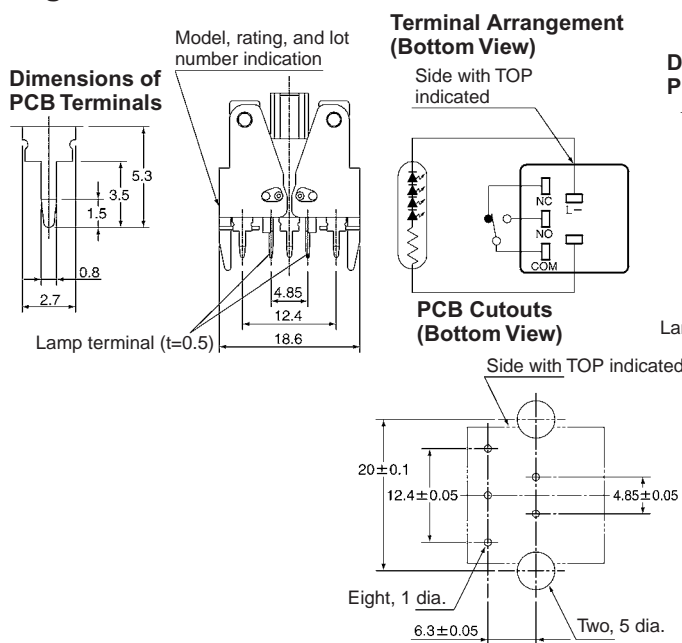

Lighted DPDT Switches

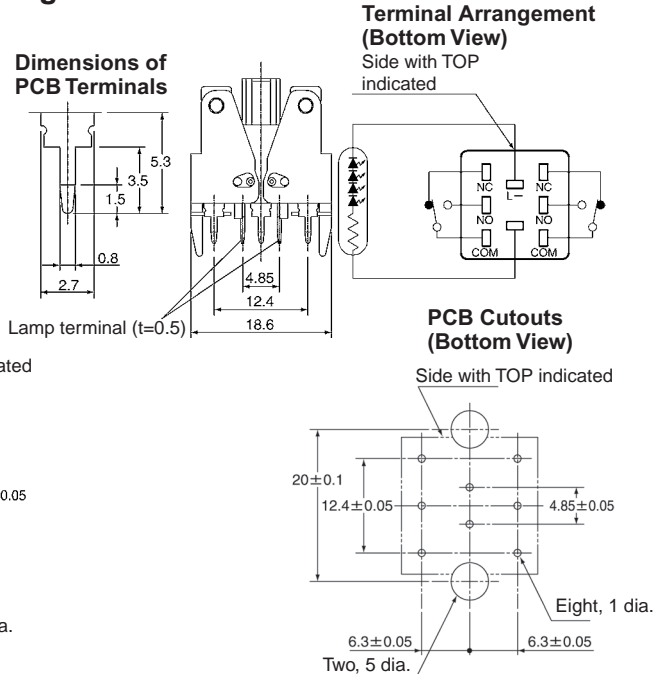

Note: For details of the terminal arrangement for Screw-Less Clamps, refer to the corresponding section for the A16.

Non-lighted Models with PCB Terminals

Lamp terminals are not provided with the Non-lighted Knob-type Selector Switches and Key-type Selector Switches.

Non-lighted SPDT Switches

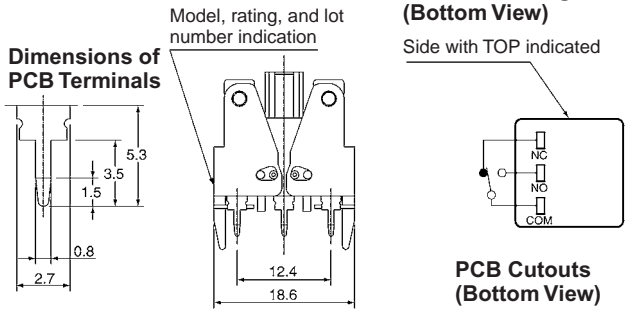

Non-lighted DPDT Switches

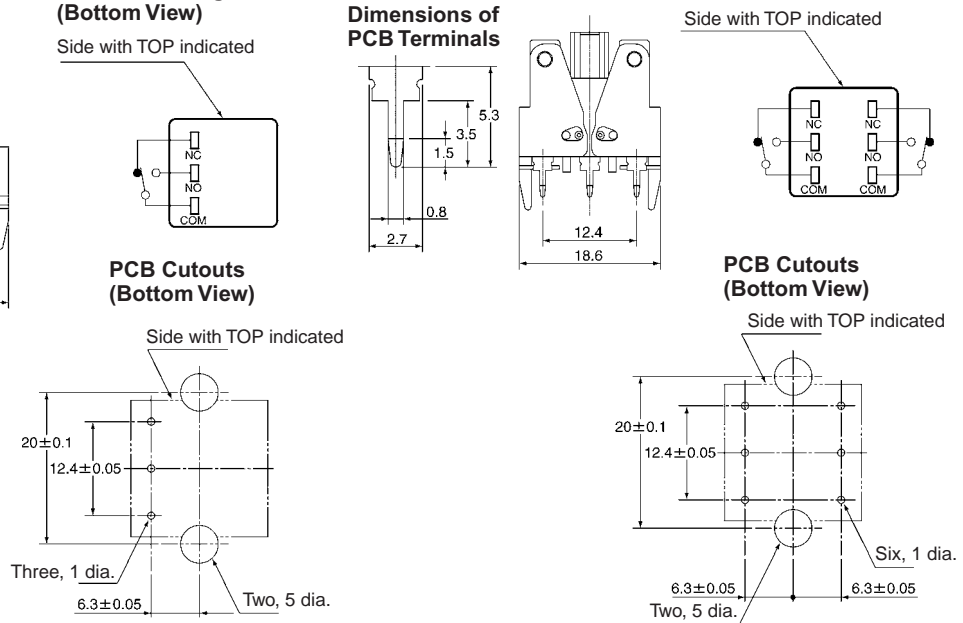

■ Panel Cutouts

Models with Solder Terminals

Rectangular
A165□-J
(Top View)

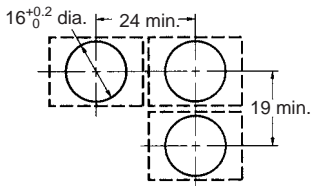

Square A165□-A
Round A165□-T
(Top View)

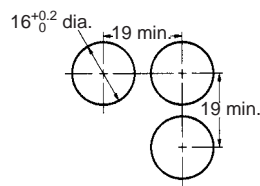

Note: 1. Make sure the thickness of the mounting panel is 0.5 to 3.2 mm.

2. If the panel is to be finished with coating, etc., make sure that the panel meets the specified dimensions after coating.

Models with PCB Terminals

Rectangular A165K-J

(Top View)

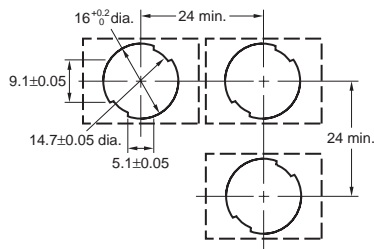

Square A165K-A Round A165K-T

(Top View)

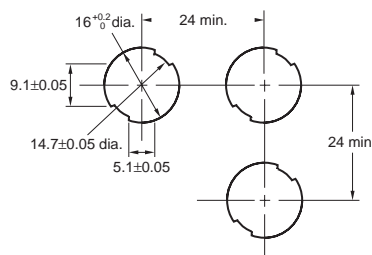

Rectangular A165K□-2S

(Top View)

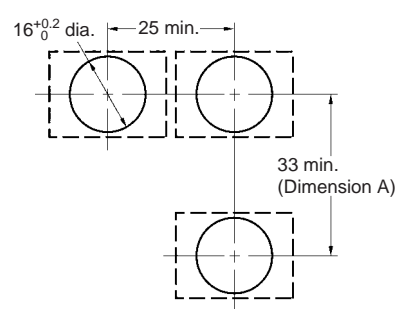

Recommended panel thickness: 0.5 to 3.2 mm

- Note:**
1. Ensure that the variation in the distance between the centers of neighboring mounting holes is less than ± 0.1 mm.
 2. Make sure the thickness of the mounting panel is 0.5 to 3.2 mm. If, however, a Switch Guard or Dust Cover is used, the thickness of the mounting panel must be 0.5 to 2 mm.
 3. If the panel is to be finished with coating, etc., make sure that the panel meets the specified dimensions after coating.

Installation

For details on mounting the Switch to a panel, and mounting and dismantling the Switch, refer to installation details for the A16 Pushbutton Switch.

■ Panel Mounting

Refer to the *Installation* section for the A16.

■ Mounting and Replacing the Pushbutton

Refer to the *Installation* section for the A16.

■ Flange Rotation

A165 Key-type Selector Switch

Fix the Switch screw and rotate the flange in 45° turns.

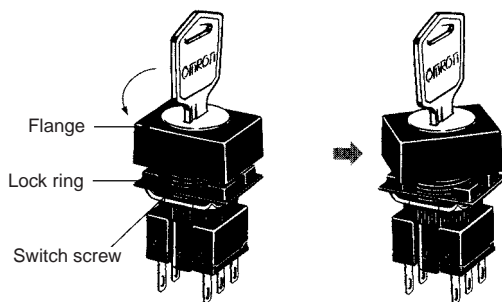

Precautions

Refer to the *Technical Information for Pushbutton Switches* (Cat. No. A143) and the *Precautions* section for the A16.

ALL DIMENSIONS SHOWN ARE IN MILLIMETERS.

To convert millimeters into inches, multiply by 0.03937. To convert grams into ounces, multiply by 0.03527.

Emergency Stop Switch A165E

Separate Construction with Smallest Class of Depth in the World

- Direct opening mechanism to open contacts in emergencies, such as when they are welded.
- Conforms to EN418.
- Includes a safety lock to prevent misuse.
- Features separate construction that allows the Switch to be separated for easier wiring and one-piece-like construction that allows easier handling.
- Models available with 3 contacts built into a single block (A165E-U).

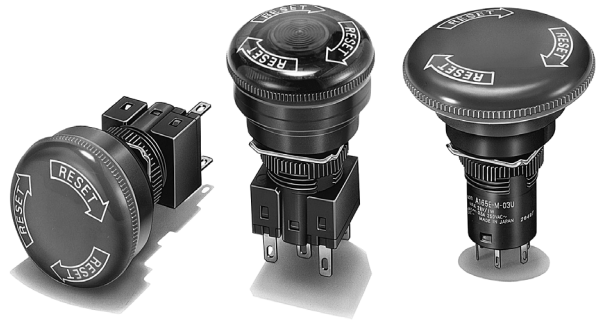

Note: Refer to the *Common Precautions* for Pushbutton Switches on page 14, as well as the *Safety Precautions* on page 121.

Model Number Structure

■ Model Number Legend

Completely Assembled

Shipped as a set that includes the Operation Unit and light source.

A165E - -

1 2 3

IP65 (Oil-resistant)

1. Operation Unit Shape and Functions

Code	Functions	Pushbutton
S	Non-lighted	30 dia.
LS	Lighted	
M	Non-lighted	40 dia.
LM	Lighted	

2. Light Source

Code	Type	Operation voltage	Rated voltage
None	Non-lighted	---	---
24D	LED	24 VDC	24 VDC

3. Contacts

Code	Description
01	SPST-NC
02	DPST-NC
03U	TPST-NC (See note.)

Note: TPST-NC models have one-piece construction with the contact unit. Only non-lighted models are available.

Note: Models with separate construction (SPST-NC and DPST-NC) are for normal loads only. One-piece models (TPST-NC) are for either normal loads or microloads.

Ordering Information



■ List of Models

Illumination	Rated voltage	Pushbutton color	Pushbutton size	Terminal	Contact	Model
LED	24 VDC	Red	30 dia.	Solder terminal	SPST-NC	A165E-LS-24D-01
Non-lighted	---				DPST-NC	A165E-LS-24D-02
					SPST-NC	A165E-S-01
LED	24 VDC				DPST-NC	A165E-S-02
			SPST-NC		A165E-LM-24D-01	
Non-lighted	---		DPST-NC		A165E-LM-24D-02	
			SPST-NC		A165E-M-01	
			DPST-NC		A165E-M-02	
		TPST-NC	A165E-M-03U			
			30 dia.			A165E-M-03U
			40 dia.			A165E-S-03U

Note: The above models have a surface indication of "RESET." Models with "STOP" indication are also available. For further information, contact your OMRON representative.

■ Individual Parts (for Switches with Separate Construction)

Operation Units

Appearance	Illumination	Model
30 dia. 	Non-lighted	A165E-S
	Lighted	A165E-LS
40 dia. 	Non-lighted	A165E-M
	Lighted	A165E-LM

Sockets

Appearance	Illumination	Contact form	Model
	Non-lighted	SPST-NC	A165E-01
		DPST-NC	A165E-02
	Lighted	SPST-NC	A165E-01L
		DPST-NC	A165E-02L





Lamps

Appearance	LED color	Rated voltage	Model	
	Red	Standard	5 VDC	A16-5DR
			12 VDC	A16-12DR
			24 VDC	A16-24DR
	Bright	Standard	5 VDC	A16-5DSR
			12 VDC	A16-12DSR
			24 VDC	A16-24DSR

Socket Units

Appearance	Illumination	Contact form	Model
	Lighted	SPST-NC	A165E-R-24D-01
		DPST-NC	A165E-R-24D-02

■ Accessories (Order Separately)

Item	Appearance	Type	Model	Precautions
Yellow Plate		Yellow, 45 dia.	A16Z-5070	Use this as an emergency stop name-plate.
Panel Plug		Rectangular	A16ZJ-3003	Used for covering the panel cutouts for future panel expansion. Degree of protection: IP40 Color: Black
		Square	A16ZA-3003	
		Round	A16ZT-3003	
Tightening Tool		---	A16Z-3004	Useful for repetitive mounting. Be careful not to tighten excessively.
Extractor			A16Z-5080	Convenient for extracting the Switch and Lamp.

Specifications

■ Certified Standards

Certification body	Standards	File No.
UL, cUL (See note.)	UL508, CSA C22.2 No.14	E41515
TÜV Product Service	EN60947-5-1, EN60947-5-5	Inquire
CQC (CCC)	GB14048.5	2003010303070678

Note: Certification for CSA C22.2 No. 14 is indicated by the  mark.

■ Certified Standard Ratings

UL508, CSA C22.2 No.14, CCC(GB14048.5)

Models with Separate Construction

Rated voltage	Resistive load
125 VAC	5 A
250 VAC	3 A
30 VDC	3 A

Models with One-piece Construction

Rated voltage	Resistive load
125 VAC	1 A
250 VAC	0.5 A
30 VDC	1 A

TÜV(EN60947-5-1)

Models with Separate Construction

Rated voltage	Resistive load
250 VAC	3 A
30 VDC	3 A

Models with One-piece Construction

Rated voltage	Resistive load
250 VAC	0.5 A
30 VDC	1 A

■ Ratings

Switch Ratings

Rated voltage	Resistive load	
	Models with Separate Construction	Models with One-piece Construction
	A165E series	A165E□-U series
125 VAC	5 A	1 A
250 VAC	3 A	0.5 A
30 VDC	3 A	1 A
Minimum applicable load	150 mA at 5 VDC	1 mA at 5 VDC

LED Ratings

(only for Models with LEDs)

Rated voltage	Rated current	Operation voltage
24 VDC	10 mA	24 VDC±5%

■ Characteristics

Item	Emergency Stop Switch		
	Non-lighted A165E-S/A165E-M	Lighted A165E-LS/A165-LM	Non-lighted, One-piece construction A165E-U
Allowable operating frequency	Mechanical	20 operations/minute max.	
	Electrical	10 operations/minute max.	
Insulation resistance	100 MΩ min. (at 500 VDC)		
Dielectric strength	1,000 VAC, 50/60 Hz for 1 min between terminals of same polarity 2,000 VAC, 50/60 Hz for 1 min between terminals of different polarity and also between each terminal and ground		
	1,000 VAC, 50/60 Hz for 1 min between lamp terminals (See note 1.) ---		
Vibration resistance	Malfunction	10 to 55 Hz, 1.5-mm double amplitude (malfunction within 1 ms)	
Shock resistance	Destruction	500 m/s ²	
	Malfunction	300 m/s ² max. (malfunction within 1 ms)	150 m/s ² max. (malfunction within 1 ms)
Durability	Mechanical	100,000 operations min.	
	Electrical	100,000 operations min.	
Ambient temperature	Operating: -10°C to 55°C (with no icing or condensation) Storage: -25°C to 65°C (with no icing or condensation)		
Ambient humidity	Operating: 35% to 85%		
Degree of protection	IP65 Oil-resistant	IP65 (See note 2.)	IP65 Oil-resistant (See note 2.)
Electric shock protection class	Class II		
PTI (tracking characteristic)	175		
Degree of contamination	3 (EN60947-5-1)		
Weight	Approx. 16 g (in case of DPST-NC Switches)		

Note: 1. LED not mounted. Test them with the LED removed.
2. Degree of protection from the front of the panel.

■ Operating Characteristics

Features	Characteristics
Operating force (OF) max.	14.7 N
Releasing force (RF) min.	0.1 N-m
Pretravel (PT)	3.5±0.5 mm (3±0.5 mm In case of A165E□-U series)

Nomenclature (Models with Separate Construction)

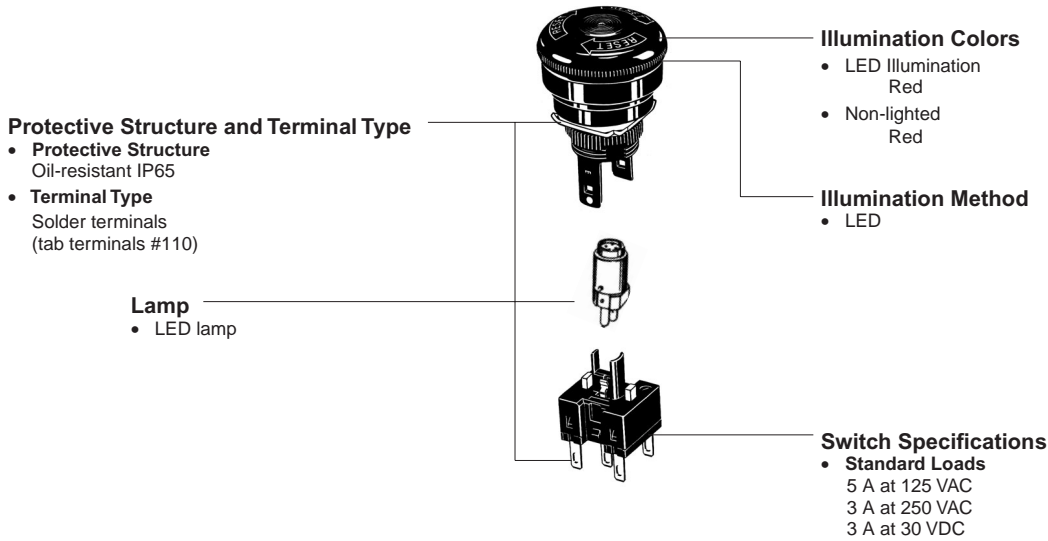

Note: A165E Emergency Stop Switch must be ordered as a set.
No LED is installed for the non-lighted models.

Push-lock, Turn-reset System Prevents Misuse

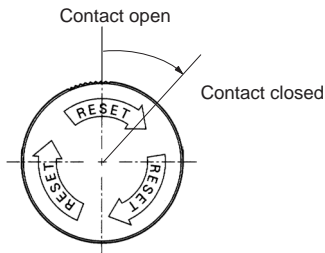

Safety Lock Prevents Misuse

Enables emergency stops only when the pushbutton is pressed intentionally and firmly.

Even if an object or person touches the pushbutton by mistake, the contact will not be released unless the pushbutton reaches the lock position.

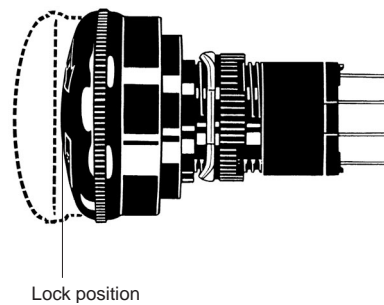

Dimensions

Note: All units are in millimeters unless otherwise indicated.

A165E-S

Non-lighted models
30 mm diameter

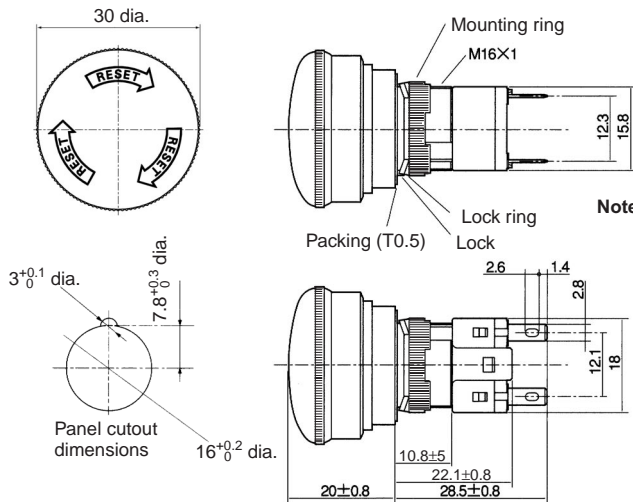
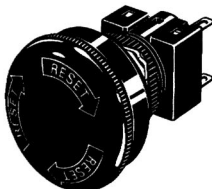

Note: 1. When applying a coating such as paint to the panel, dimensions after the coating must satisfy the specified dimensions.

2. Recommended panel thickness: 0.5 to 3.2 mm.

A165E-LS

Lighted models
30 mm diameter

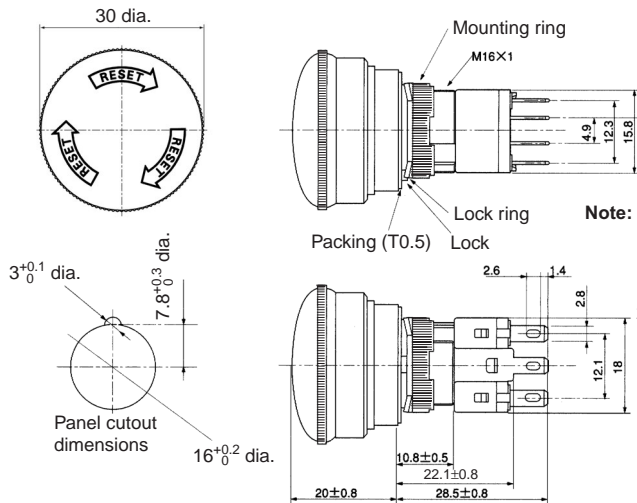

Note: 1. When applying a coating such as paint to the panel, dimensions after the coating must satisfy the specified dimensions.

2. Recommended panel thickness: 0.5 to 3.2 mm.

A165E-S-03U

Non-lighted,
one-body models
30 mm diameter

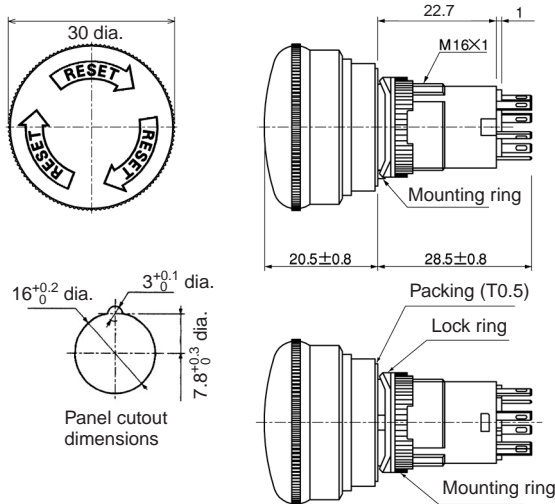

Note: 1. When applying a coating such as paint to the panel, dimensions after the coating must satisfy the specified dimensions.

2. Recommended panel thickness: 0.5 to 3.2 mm.

A165E-M

Non-lighted models
40 mm diameter

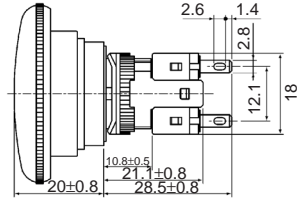
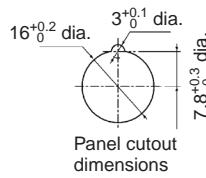
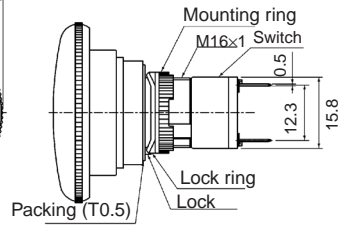
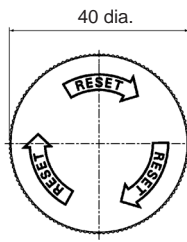
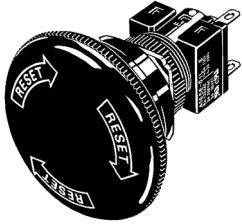

Note: 1. When applying a coating such as paint to the panel, dimensions after the coating must satisfy the specified dimensions.

2. Recommended panel thickness: 0.5 to 3.2 mm.

A165E-LM

Lighted models
40 mm diameter

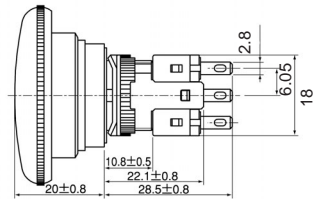
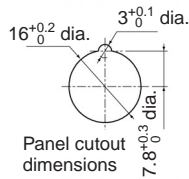
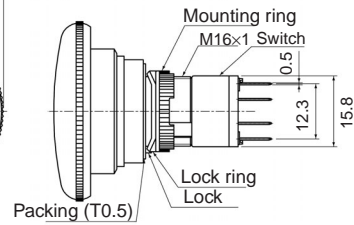
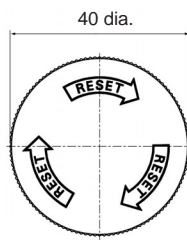

Note: 1. When applying a coating such as paint to the panel, dimensions after the coating must satisfy the specified dimensions.

2. Recommended panel thickness: 0.5 to 3.2 mm.

A165E-M-03U

One-body models
40 mm diameter

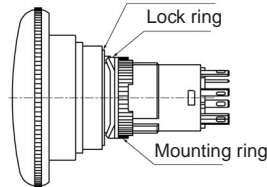
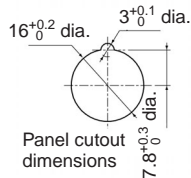
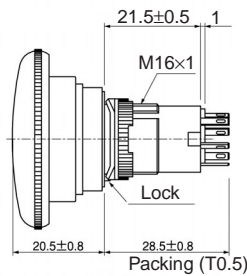
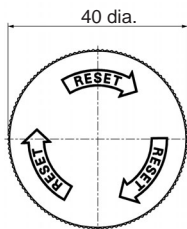
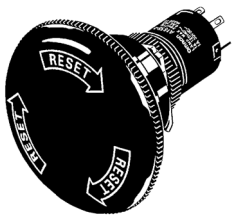

Note: 1. When applying a coating such as paint to the panel, dimensions after the coating must satisfy the specified dimensions.

2. Recommended panel thickness: 0.5 to 3.2 mm.

■ Accessories

Yellow Plate (Vinyl Chloride)

A16Z-5070

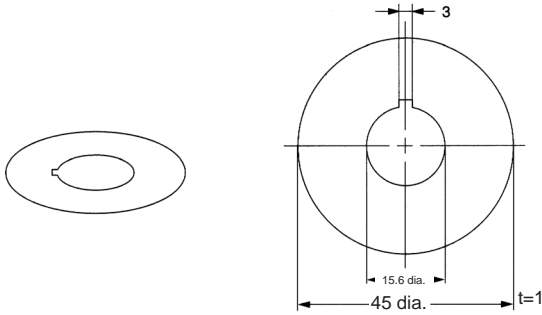

Lock Ring

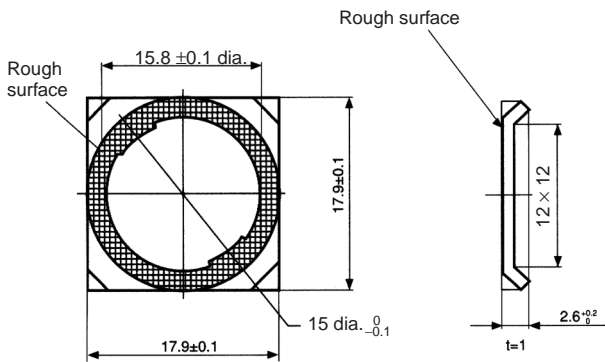

■ Terminal Arrangement

SPST Switches

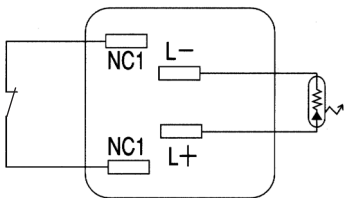

DPST Switches

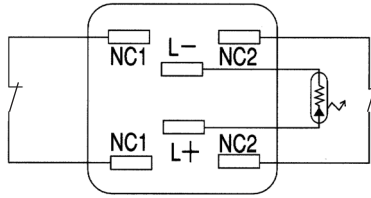

TPST Switches

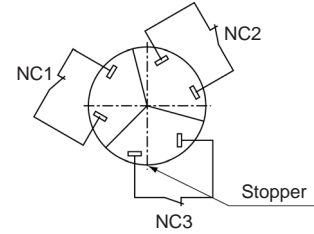

Note: The L+ and L- terminals are not available with the non-lighted models.

Panel Plugs

Select an appropriate Panel Plug according to the panel design and mount from the front side of the panel. Panel cutout dimensions are the same as those for the Switch.

Rectangular	Square	Round

Screw Fitting

A16Z-3004

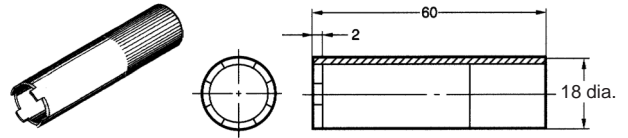

Installation

■ Mounting to the Panel

After installing the Operation Unit, snap in the Switch from the back of the panel.

1. Installing the Switch

Attach rubber packing or the Yellow Plate onto the Switch from its terminal side. Insert the Switch into the panel from the front. Install the lock ring and mounting nut from the terminal side and tighten.

Adjust the slits on the hole of rubber packing and Yellow Plate to the protruding part of the Unit.

Rubber packing is not necessary when the Yellow Plate is used.

Tighten the nut to the torque of 0.29 to 0.49 N·m.

Casing should be installed with its protruding part adjusted to the slit of the panel hole.

Align the lock ring to the groove of the casing so that the edge is drawn to the panel side.

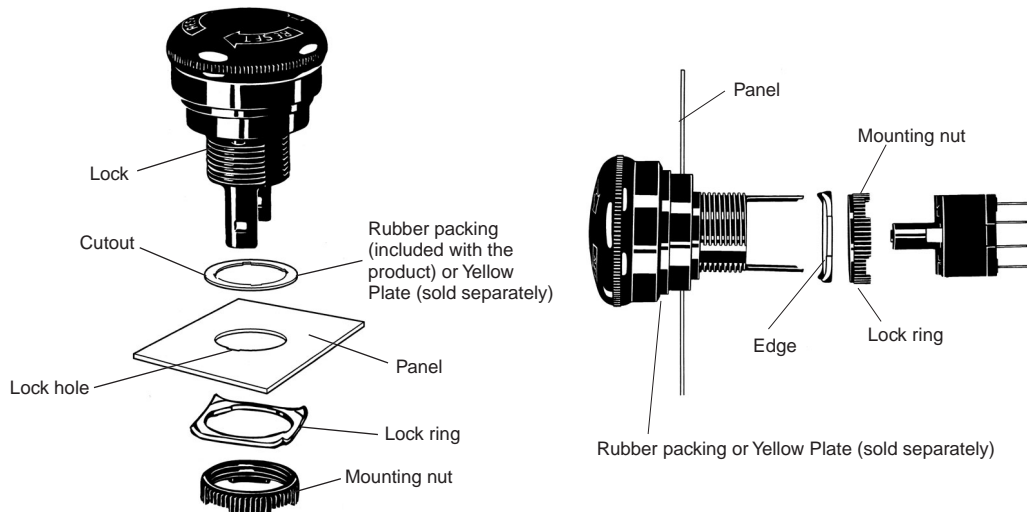

2. Mounting the Switch

Snap on the Switch to the Operation Unit.

Make sure that the Switch has the correct orientation when snapping it onto the Operation Unit. Align the white dot on the Operation Unit with the guide groove on the side of the Switch marked with an "L" as shown below, and push the Switch into the Operation Unit until it clicks into place. Confirm that the Switch is securely in place before using.

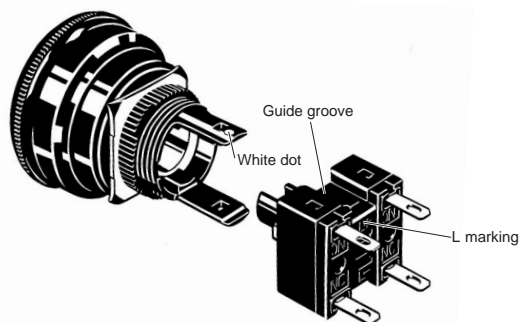

3. Removing the Switch

Insert the prongs of the A16Z-5080 Extractor between the Switch and the Operation Unit, grip the Switch, and pull to remove.

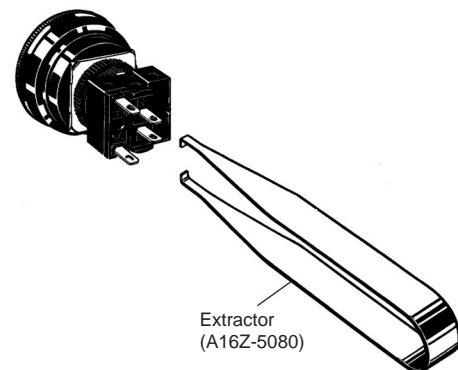

4. Installing the LED Lamp

When mounting the Lamp, make sure it is facing the direction shown in the following diagram. Insert the Lamp while matching the protruding part of the Lamp and the small guides on the outer surface of the casing.

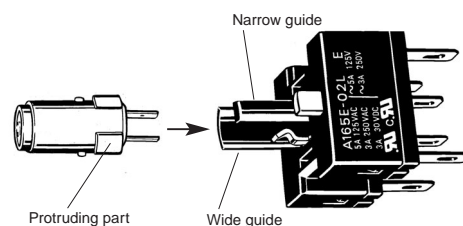

Safety Precautions

Refer to the *Common Precautions* for Pushbutton Switches on page 14.

■ Precautions for Correct Use

Mounting

Always make sure that the power is turned OFF before mounting, removing, or wiring the Switch, or performing maintenance. Electrical shock or fire may result if the power is not turned OFF.

The tightening torque is 0.29 to 0.49 N·m.

Wiring

Be sure to use electrical wires that are a size appropriate for the applied voltage and carry current. Perform soldering according to the conditions given below. If the soldering is not properly performed, abnormal heating may result, possibly resulting in fire.

1. Hand soldering: 30 W, within 5 s
2. Dip soldering: 240°C, within 3 s

Wait for one minute after soldering before exerting any external force on the solder.

Use non-corrosive resin fluid as the flux.

Make sure that the electric cord is wired so that it does not touch the Unit. If the electric cord will touch the Unit, then electric wires with a heat resistance of 100°C min. must be used.

After wiring the Switch, maintain an appropriate clearance and creepage distance.

Operating Environment

The IP65 model is designed with a degree of protection so that it will not sustain damage if it is subjected to water from any direction to the front of the panel.

Using the Microload

Insert a contact protection circuit, if necessary, to prevent the reduction of life expectancy due to extreme wear on the contacts caused by loads where inrush current occurs when the contact is opened and closed.

The A165E-□U allows both a standard load (125 V at 1 A, 250 V at 0.5 A) and a microload. If a standard load is applied, however, the microload area cannot be used. If the microload area is used with a standard load, the contact surface will become rough, and the opening and closing of the contact for a microload may become unreliable.

The minimum applicable load is the N-level reference value. This value indicates the malfunction reference level for the reliability level of 60% (λ 60) (conforming to JIS C5003).

The equation, λ 60 = 0.5×10^{-6} /time indicates that the estimated malfunction rate is less than 1/2,000,000 with a reliability level of 60%.

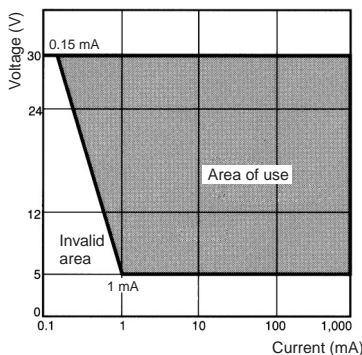

LEDs

The LED current-limiting resistor is built-in, so internal resistance is not required.

Rated voltage	Internal limiting resistor
24 VDC	2000 Ω

Operating Torque

Do not exceed an operating torque of 0.49 N·m in the direction of rotation.

Do not pull the operating button or apply excessive force to any side of the button. Otherwise it may be damaged.

Others

The oil-resistant IP65 uses NBR rubber and is resistant to general cutting oil and cooling oil. Some particular oils cannot be used with the oil-resistant IP65, however, so contact your OMRON representative for details.

When painting or coating the panel, make sure that the specified panel dimensions apply to the panel after painting or coating.

Due to the structure of the switch, severe shock or vibration may cause malfunctions or damage to the switch. Also, most switches are made from resin and will be damaged if they come into contact with sharp objects. Particularly scratches on the Operation Unit may create visual and operational obtrusions. Handle the switches with care, and do not throw or drop them.

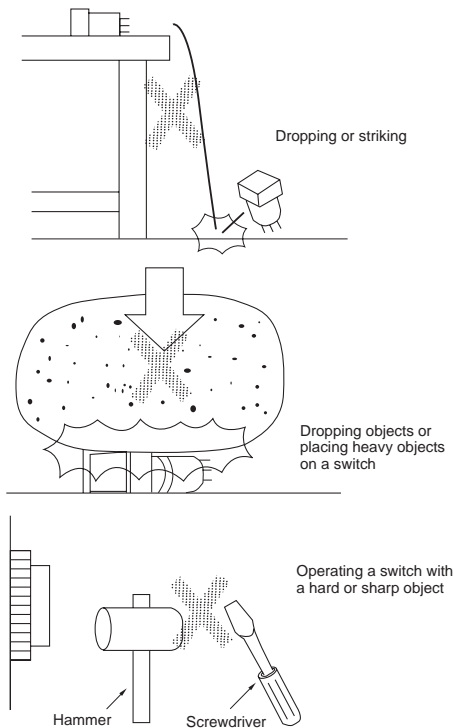

ALL DIMENSIONS SHOWN ARE IN MILLIMETERS.
To convert millimeters into inches, multiply by 0.03937. To convert grams into ounces, multiply by 0.03527.

Indicator M16

Cylindrical 16-dia. Indicator

- Same basic design as the A16 Pushbutton Switch.
- UL and cUL approved (File No. E41515).

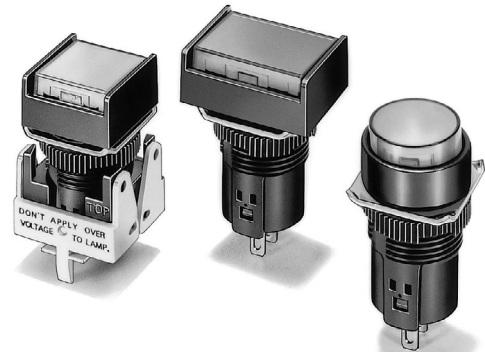

Model Number Structure

Model Number Legend

Completely Assembled

The model numbers used to order sets of Units are illustrated below. One set comprises the Display, Case, Lamp, and Socket.

M 1 6 **5** - **T** **R** - **24D** - **S**

(1) Degree of Protection

Symbol	Protection
No symbol	IP40
5	IP65 oil-resistant

(2) Shape of Display

Symbol	Shape
J	Rectangular
A	Square
T	Round

(3) Color of Display

Symbol	Color
R	Red
G	Green
Y	Yellow
PY	Pure yellow
W	White
A	Blue

(4) Light Source

Symbol	Type	Operating voltage	Rated voltage
5	Incandescent lamp	5 VAC/VDC	6 VAC/VDC
12		12 VAC/VDC	14 VAC/VDC
24		24 VAC/VDC	28 VAC/VDC
5D	LED	5 ±5% VDC	5 VDC
12D		12 ±5% VDC	12 VDC
24D		24 ±5% VDC	24 VDC

Voltage Reduction Unit (24-V Built-in LED)

Symbol	Type	Operating voltage	Rated voltage
T1	LED	90 to 121 VAC/VDC	110 VAC/VDC
T2		180 to 242 VAC/VDC	220 VAC/VDC

Solder terminals are available only with 100-V models.

(5) Terminal Type

Symbol	Terminal type
No symbol	Solder terminals
S	Screw-Less Clamp

Ordering Information

■ List of Models

Ordering as a Set

The model numbers used to order sets of Units are given in the following tables. One set comprises the Display, Case, Lamp, and Socket.

M16□-J (Rectangular) Models

Solder Terminal Models

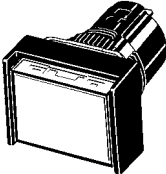
Appearance	Lighting	Operating voltage	IP40	IP65 oil-resistant	Display color symbol (See note.)
	LED without Voltage Reduction Unit	5 VDC	M16-J□-5D	M165-J□-5D	R: red Y: yellow G: green A: blue W: white PY: Pure yellow
		12 VDC	M16-J□-12D	M165-J□-12D	
		24 VDC	M16-J□-24D	M165-J□-24D	
	Incandescent lamp	5 VDC/VAC	M16-J□-5	M165-J□-5	
		12 VDC/VAC	M16-J□-12	M165-J□-12	
		24 VDC/VAC	M16-J□-24	M165-J□-24	

M16□-A (Square) Models

Solder Terminal Models

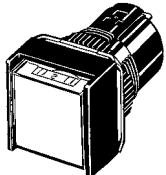
Appearance	Lighting	Operating voltage	IP40	IP65 oil-resistant	Display color symbol (See note.)
	LED without Voltage Reduction Unit	5 VDC	M16-A□-5D	M165-A□-5D	R: red Y: yellow G: green A: blue W: white PY: Pure yellow
		12 VDC	M16-A□-12D	M165-A□-12D	
		24 VDC	M16-A□-24D	M165-A□-24D	
	Incandescent lamp	5 VDC/VAC	M16-A□-5	M165-A□-5	
		12 VDC/VAC	M16-A□-12	M165-A□-12	
		24 VDC/VAC	M16-A□-24	M165-A□-24	

M16□-T (Round) Models

Solder Terminal Models

Appearance	Lighting	Operating voltage	IP40	IP65 oil-resistant	Display color symbol (See note.)
	LED without Voltage Reduction Unit	5 VDC	M16-T□-5D	M165-T□-5D	R: red Y: yellow G: green A: blue W: white PY: Pure yellow
		12 VDC	M16-T□-12D	M165-T□-12D	
		24 VDC	M16-T□-24D	M165-T□-24D	
	Incandescent lamp	5 VDC/VAC	M16-T□-5	M165-T□-5	
		12 VDC/VAC	M16-T□-12	M165-T□-12	
		24 VDC/VAC	M16-T□-24	M165-T□-24	

Note: Enter the desired color symbol for the Display in □.

Ordering Individually

Displays, Cases, Lamps, and Sockets can be ordered separately. Combinations that are not available as sets can be created using individual parts. Also, store the parts as spares for maintenance and repairs.

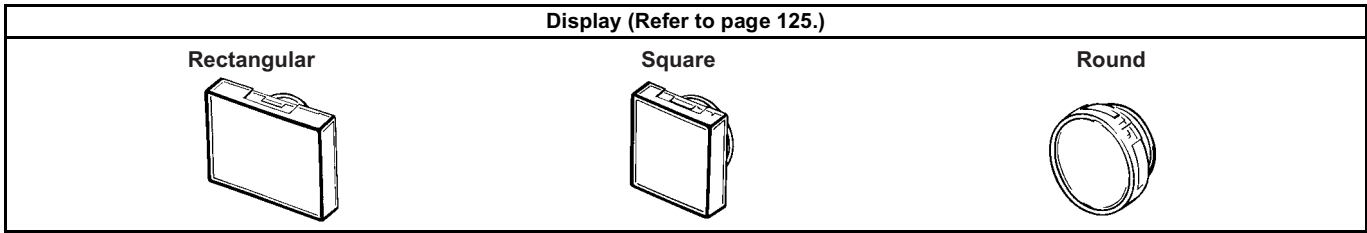

Note: Use IP40 Displays in combination with IP40 Sockets and use IP65 Displays in combination with IP65 Sockets.

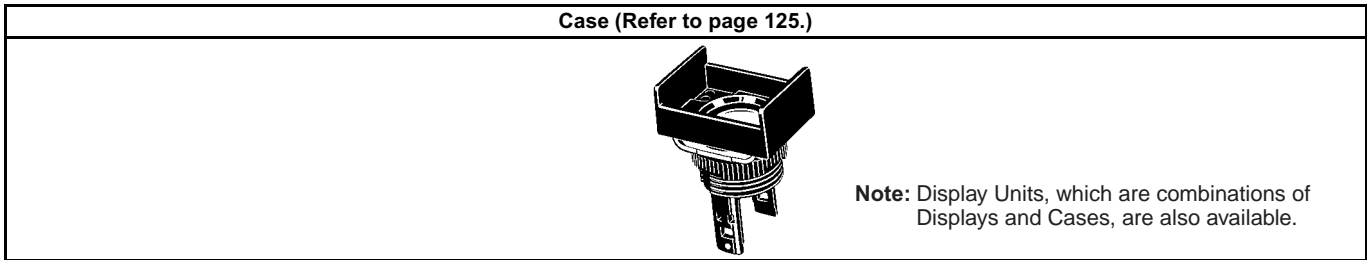



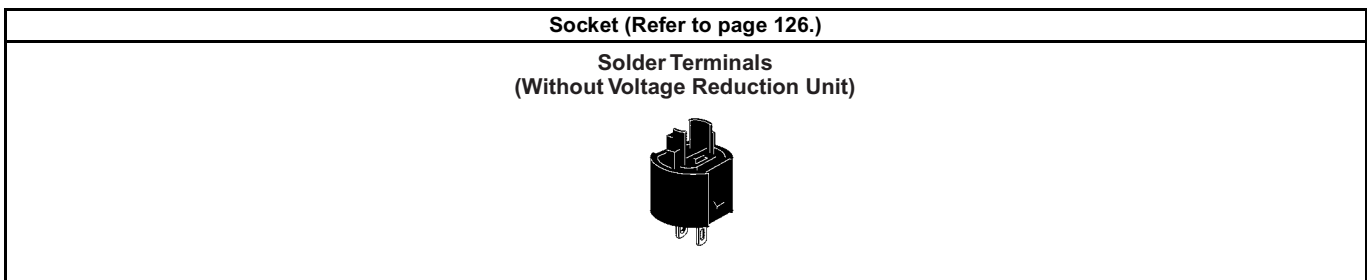
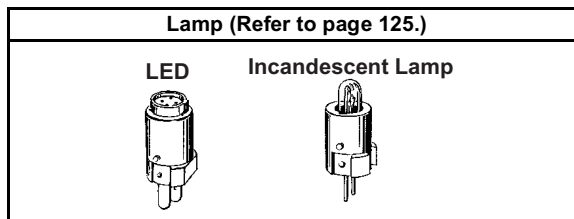



Lighted Models









Note: Socket Units, which are combinations of Lamps and Sockets, are also available.

Display

For LED-lighted Models

Sealing Appearance	IP40			IP65 oil-resistant		
	Rectangular 	Square 	Round 	Rectangular 	Square 	Round 
Color of Display						
Red	A16L-JR	A16L-AR	A16L-TR	A165L-JR	A165L-AR	A165L-TR
Yellow	A16L-JY	A16L-AY	A16L-TY	A165L-JY	A165L-AY	A165L-TY
Pure yellow	A16L-JPY	A16L-APY	A16L-TPY	A165L-JPY	A165L-APY	A165L-TPY
Green	A16L-JGY	A16L-AGY	A16L-TGY	A165L-JGY	A165L-AGY	A165L-TGY
White	A16L-JW	A16L-AW	A16L-TW	A165L-JW	A165L-AW	A165L-TW
Blue	A16L-JA	A16L-AA	A16L-TA	A165L-JA	A165L-AA	A165L-TA

Incandescent Lamps (With the exception of green, the Units are the same as for LEDs.)

Sealing Appearance	IP40			IP65 oil-resistant		
	Rectangular 	Square 	Round 	Rectangular 	Square 	Round 
Color of Display						
Red	A16L-JR	A16L-AR	A16L-TR	A165L-JR	A165L-AR	A165L-TR
Yellow	A16L-JY	A16L-AY	A16L-TY	A165L-JY	A165L-AY	A165L-TY
Pure yellow	A16L-JPY	A16L-APY	A16L-TPY	A165L-JPY	A165L-APY	A165L-TPY
Green	A16L-JG	A16L-AG	A16L-TG	A165L-JG	A165L-AG	A165L-TG
White	A16L-JW	A16L-AW	A16L-TW	A165L-JW	A165L-AW	A165L-TW
Blue	A16L-JA	A16L-AA	A16L-TA	A165L-JA	A165L-AA	A165L-TA

Lamp

LED

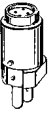
	Color	Operating voltage		
		5 VDC	12 VDC	24 VDC
	Red	A16-5DSR	A16-12DSR	A16-24DSR
Yellow	A16-5DSY	A16-12DSY	A16-24DSY	
Green	A16-5DSG	A16-12DSG	A16-24DSG	
White (See note.)	A16-5DSW	A16-12DSW	A16-24DSW	
Blue	A16-5DA	A16-12DA	A16-24DA	

Note: Use the white LED when the required illumination color is white or pure yellow.

Incandescent Lamp

	Operating voltage	5 VAC/VDC	12 VAC/VDC	24 VAC/VDC
	Model		A16-5	A16-12

Case

Appearance	Classification		Model number
	IP40	Rectangular	A16-CJM
		Square	A16-CAM
		Round	A16-CTM
	IP65 oil-resistant	Rectangular	A165-CJM
		Square	A165-CAM
		Round	A165-CTM

Socket

Appearance	Classification			Model number
 <p>Solder terminals</p>	Solder terminals			M16-0
	PCB terminals			M16-0P
	Screw-Less Clamp			M16-S
	Solder terminals	Voltage-reduction lighting	100 V	M16-T1
			100 V	M16-T1-S
Screw-Less Clamp		200 V	M16-T2-S	

Specifications

■ Approved Standards

Agency	Standards	File No.
UL, cUL (See note.)	UL508	E41515

Note: cUL: CSA, C22.2 No. 14

■ Ratings

Super-bright LED

Rated voltage	Rated current	Operating voltage	Built-in limiting resistance
5 VDC	30 mA (red: 15 mA)	5 VDC ±5%	33 Ω (blue: 51 Ω, red: 68 Ω)
12 VDC	15 mA	12 VDC ±5%	270 Ω (blue: 270 Ω, red 560 Ω)
24 VDC	10 mA	24 VDC ±5%	1,600 Ω (blue: 1.8 kΩ, red: 2 kΩ)

Note: The values in parentheses are for blue or red Pushbuttons.

Incandescent Lamp

Rated voltage	Rated current	Operating voltage
6 VAC/VDC	60 mA	5 VAC/VDC
14 VAC/VDC	40 mA	12 VAC/VDC
28 VAC/VDC	24 mA	24 VAC/VDC

Neon Lamp

Rated voltage	Rated current	Operating voltage
110 VAC	1.5 mA	100 VAC ±10%
220 VAC	1.5 mA	200 VAC ±10%

■ Characteristics

Ambient operating temperature	-10°C to 55°C (with no icing or condensation)
Ambient operating humidity	35% to 85%
Ambient storage temperature	-25°C to 65°C

Note: Characteristics not provided above are the same as those for the A16.

Screw-less Clamp

Item	Screw-less Clamp				
Recommended wire size	0.5 mm ² twisted wire or 0.8 mm-dia. solid wire				
Usable wires and tensile strength	Twisted wire	0.3 mm ²	0.5 mm ²	0.75 mm ²	1.25 mm ²
	Solid wire	0.5 mm dia.	0.8 mm dia.	1.0 mm dia.	---
	Tensile strength	10 N	20 N	30 N	40 N
Length of exposed wire	10 ±1 mm				

Dimensions

Note: 1. All units are in millimeters unless otherwise indicated.
 2. Refer to page 129 for details of panel cutout dimensions.

Rectangular M16-J

Solder terminals

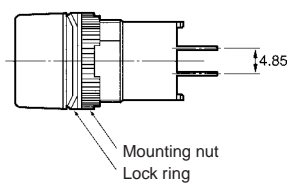
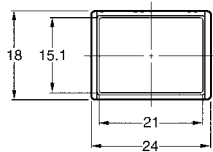
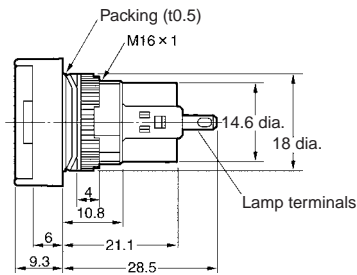

Square M16-A

Solder terminals

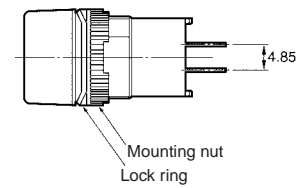
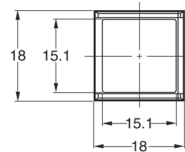
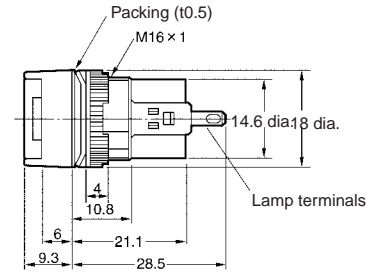
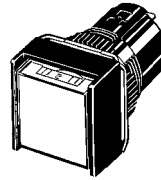

Round M16-T

Solder terminals

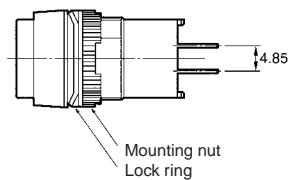
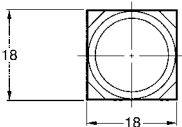
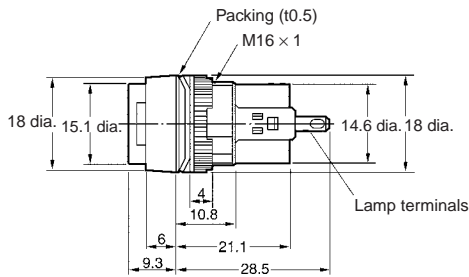

Terminal Hole Dimensions

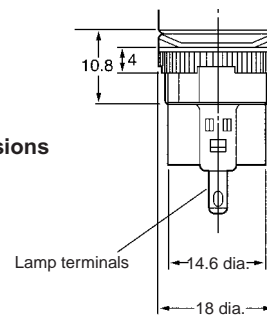
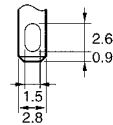

**Rectangular
M16□-P**

PCB terminals

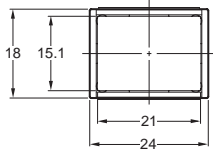

The rectangular model is given here as a representative example. Lamp terminals are provided even for non-lighting applications.

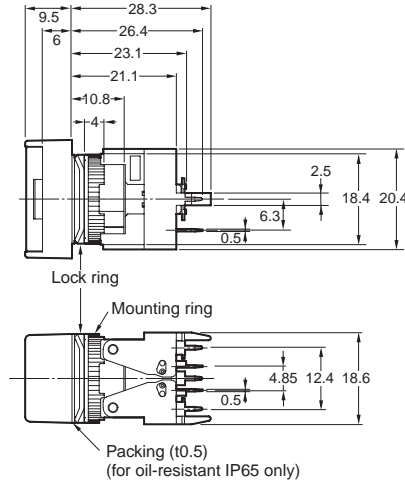

Panel Cutouts

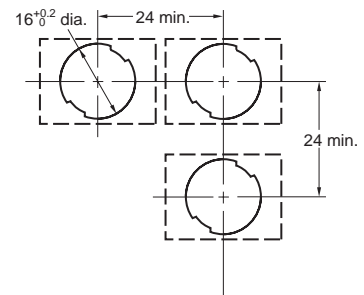

Recommended panel thickness: 0.5 to 3.2 mm

**Rectangular
M16□-T1, T2**

Voltage-reduction lighting,
solder terminals

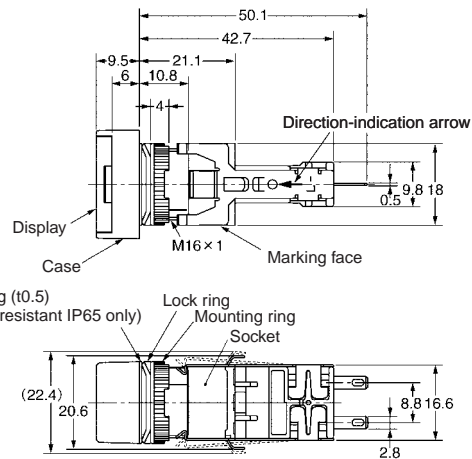
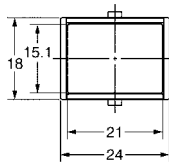
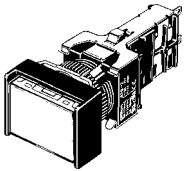

Panel Cutouts

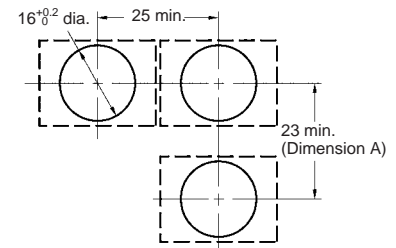

Recommended panel thickness: 0.5 to 3.2 mm

**Rectangular
M16□-S**

Screw-Less Clamp

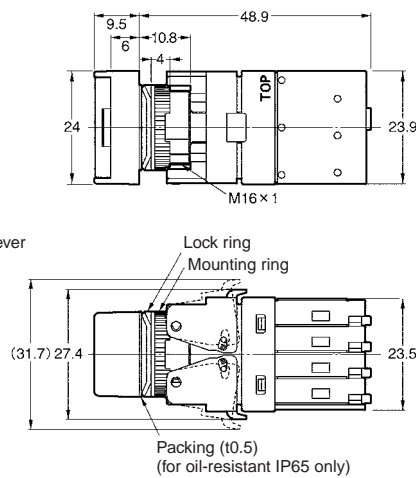
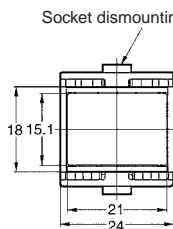
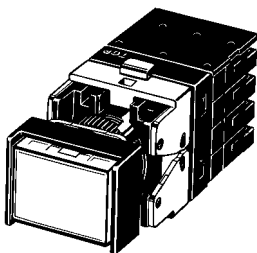

Terminal Arrangement

Solder Terminals

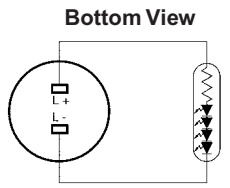

Note: The L+ is not shown on the Socket Unit.

Screw-Less Clamp

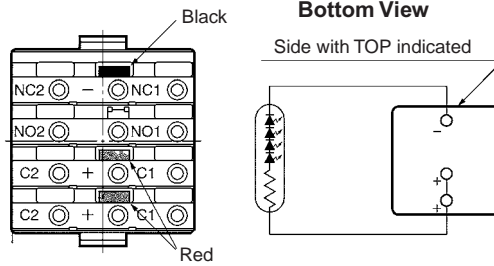

Voltage-reduction Lighting

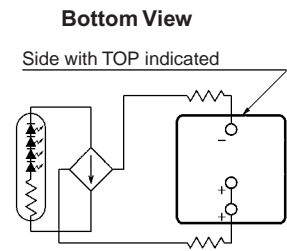

Note: Voltage-reduction lighting models with Screw-Less Clamps (A16L-□T1-2S, A16L-□T2-2S) incorporate voltage-reduction circuits.

Panel Cutouts

Solder Terminals

Solder Terminals

Rectangular M16□-J

(Top View)

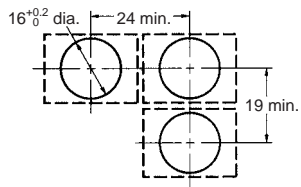

Square M16□-A Round M16□-T

(Top View)

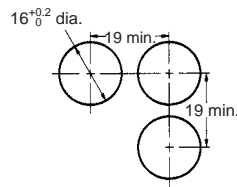

Screw-Less Clamp

Rectangular M16□-S

(Top View)

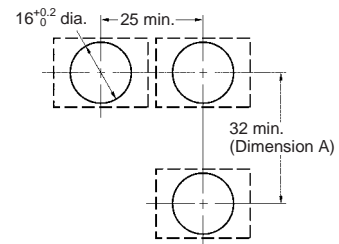

Note: 1. Make sure the thickness of the mounting panel is 0.5 to 3.2 mm. If, however, a Switch Guard or Dust Cover is used, the thickness of the mounting panel must be 0.5 to 2 mm.

2. If the panel is to be finished with coating, etc., make sure that the panel meets the specified dimensions after coating.

Installation

Refer to the *Installation* section for the A16.

Precautions

Refer to the *Technical Information for Pushbutton Switches* (Cat. No. A143) and the *Precautions* section for the A16.

■ Correct Use

Mounting

When mounting the Case onto the Socket Unit, ensure that the orientation is correct. Perform mounting with the • mark on the Case and the TOP mark on the Socket Unit facing in the same direction.

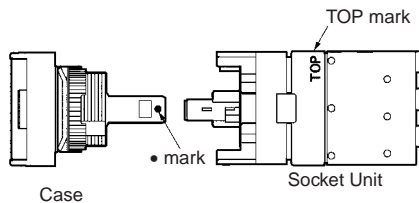

Wiring

When using stranded wire, gather the ends of the strands together before wiring.

When wiring, insert the wire until it comes into contact with something. After wiring is completed, pull on the wires to confirm that they are connected securely.

After wiring, ensure that continuous pressure is not applied to the terminals.

Refer to internal connections diagrams and confirm the terminal numbers before performing wiring.

Screw-Less Clamps

Mounting Procedure

1. Strip a length of 10 mm off the end of the wire (allowable range: 10 ± 1 mm).
2. Bunch wire strands together and straighten them.
3. Insert the wire into the insertion hole while pressing the release button at the side of the hole. (Using a precision screwdriver is recommended.)
4. Let go of the release button to lock the wire into place.
5. After locking, pull on the wire gently to confirm that it is securely locked.

Removing Procedure

Remove wires by pulling them while pressing the release button.

Note: When reusing wires that have already been locked, cut off the end of the wire and strip the wire again before using.

ALL DIMENSIONS SHOWN ARE IN MILLIMETERS.

To convert millimeters into inches, multiply by 0.03937. To convert grams into ounces, multiply by 0.03527.

16-mm Diameter Panel-Mounted Buzzer Unit

- Four models offer eight different types of sounds, plus two modes newly added to the high-sound models
- Intermittent or continuous sound selected by jumper setting
- Three supply voltages: 6 VAC/VDC and 12 to 24 VAC/VDC
- Jumper storage provided at bottom of Unit
- Complements the A16 range of Pushbuttons, Selector Switches, and Key Switches.



Ordering Information

■ List of Models

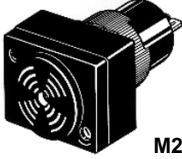
Item		Standard sound				High sound	
							
		M2BJ-B				M2BJ-BH	
Sound	w/jumper	Intermittent	Intermittent (short)	Intermittent (high-pitched)	Intermittent (short, high-pitched)	Intermittent (high-pitched)	Intermittent (short)
	w/o jumper	Continuous	Intermittent (long)	Continuous (high-pitched)	Intermittent (long, high-pitched)	Continuous	Intermittent (long)
Supply voltage	6 VAC/VDC	M2BJ-B06	M2BJ-B06A	M2BJ-B06B	M2BJ-B06C	M2BJ-BH06D	M2BJ-BH06E
	12 to 24 VAC/VDC	M2BJ-B24	M2BJ-B24A	M2BJ-B24B	M2BJ-B24C	M2BJ-BH24D	M2BJ-BH24E
	12 to 24 VDC	M2BJ-B24-D	---	M2BJ-B24B-D	---	M2BJ-BH24D-D	M2BJ-BH24E-D

Note: High-sound models incorporate an LED, which lights when the Buzzer sounds.

Specifications

■ Standard-sound Models

6-V Models

Model	M2BJ-B06	M2BJ-B06A	M2BJ-B06B	M2BJ-B06C
Rated voltage	6 VAC/VDC			
Sound pressure (See note.)	Continuous sound: 80 dB (phons) min.			
Driving frequency	2±0.5 kHz		4±0.5 kHz	
Intervals	190 times/minute±10%	Long: 55 times/minute±10% Short: 700 times/minute±10%	190 times/minute±10%	Long: 55 times/minute±10% Short: 700 times/minute±10%
Current consumption	DC	7 mA max.		20 mA max.
	AC	20 mA max.		
Inrush current	1 A max.			
Life expectancy	1,000 hours min.			
Insulation resistance	100 MΩ min. (between ground and current-carrying parts)			
Dielectric strength	1,000 VAC for 1 minute (between grounds)			
Ambient temperature	Operating: -10°C to 55°C (no icing or condensation) Storage: -25°C to 65°C (no icing or condensation)			
Humidity	35% to 85%			
Weight	Approx. 9 g			

Note: The figure for sound pressure given above is for measurement at a distance of 0.1 m at the rated voltage.

12 to 24-V Models

Model	M2BJ-B24	M2BJ-B24A	M2BJ-B24B	M2BJ-B24C	M2BJ-B24-D	M2BJ-B24B-D
Rated voltage	12 to 24 VAC/VDC				12 to 24 VDC	
Sound pressure (See note.)	Continuous sound: 80 dB (phons) min.					
Driving frequency	2±0.5 kHz		4±0.5 kHz		2±0.5 kHz, 4±0.5 kHz	
Intervals	190 times/minute ±10%	Long: 55 times/minute± 10% Short: 700 times/minute ±10%	190 times/minute ±10%	Long: 55 times/minute± 10% Short: 700 times/minute ±10%	190 times/minute±10%	
Current consumption	DC	7 mA max.		20 mA max.		7 mA max. 20 mA max.
	AC	20 mA				---
Inrush current	1 A max.				---	
Life expectancy	1,000 hours min.					
Insulation resistance	100 MΩ min. (between ground and current-carrying parts)					
Dielectric strength	1,000 VAC for 1 minute (between grounds)					
Ambient temperature	Operating: -10°C to 55°C (no icing or condensation) Storage: -25°C to 65°C (no icing or condensation)					
Humidity	35% to 85%					
Weight	Approx. 9 g					

Note: The figure for sound pressure given above is for measurement at a distance of 0.1 m at the rated voltage.

■ High-sound Models (LED is incorporated)

Model	M2BJ-BH06D	M2BJ-BH24D	M2BJ-BH06E	M2BJ-BH24E	M2BJ-BH24D-D	M2BJ-BH24E-D
Rated voltage	6 VAC/VDC	12 to 24 VAC/VDC	6 VAC/VDC	12 to 24 VAC/VDC	12 to 24 VDC	
Sound pressure (See note.)	70 to 100 dB (phons)					
Driving frequency	2.8±0.5 kHz					
Intervals	Approx. 190 times/min.		Long: Approx. 55 times/min. Short: Approx. 700 times/min.		Approx. 190 times/min.	Long: Approx. 55 times/min. Short: Approx. 700 times/min.
Current consumption	DC	50 mA max.				
	AC	100 mA max.			---	
Inrush current	1 A max.			---		
Life expectancy	1,000 hours min.					
Insulation resistance	100 MΩ min. (between ground and current-carrying parts)					
Dielectric strength	1,000 VAC for 1 minute (between grounds)					
Ambient temperature	Operating: -10°C to 55°C (no icing or condensation) Storage: -25°C to 65°C (no icing or condensation)					
Humidity	35% to 85%					
Weight	Approx. 13 g					

Note: The sound pressure can be adjusted. The figure for sound pressure given above is for measurement at a distance of 0.1 m at the rated voltage.

Operation

■ Contact Form

All Models

(Standard and High-sound Models)

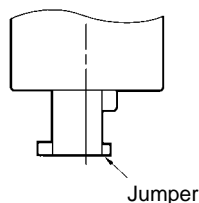

Terminal Hole Dimensions

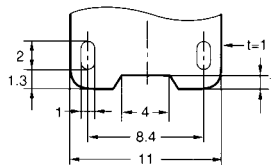

Terminal Arrangement (Bottom view)

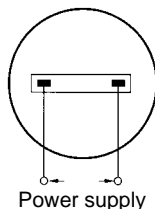

Note: There is no +/- polarity.

Dimensions

Note: All units are in millimeters unless otherwise indicated.

M2BJ-B Standard-sound Models

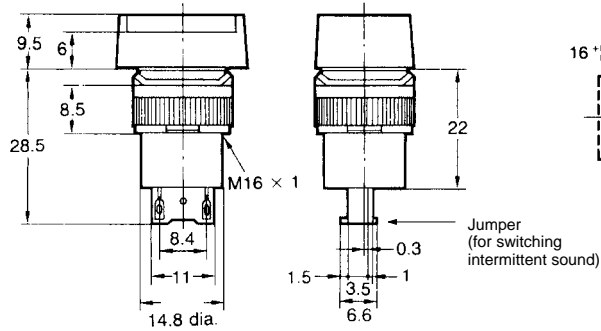
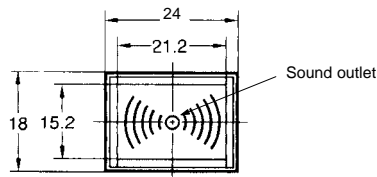
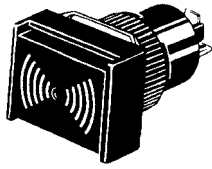

Panel cutout (Top view)

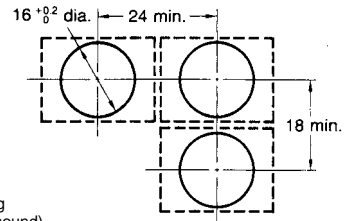

M2BJ-BH High-sound Models

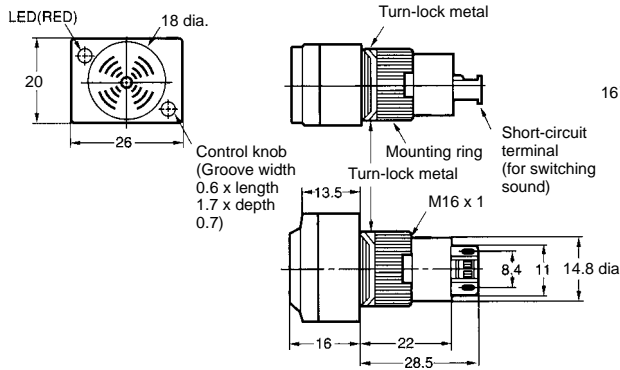
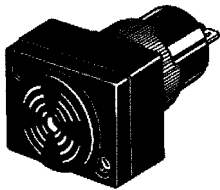

Panel cutout (Top view)

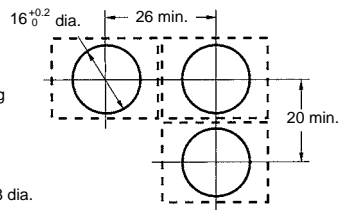

Note: Recommended panel thickness: 1.0 to 3.2 mm.

M2BJ-BH24D-DA External Signal Selection Model

An external signal selection model is also available. With this model, it is possible to switch between continuous and intermittent sound using an external signal instead of the jumper.

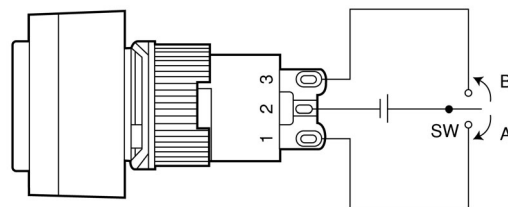
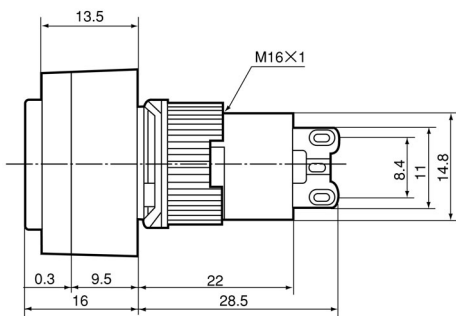

SW:
When A direction is ON (terminals 1, 2 ON): intermittent sound
When B direction is ON (terminals 2, 3 ON): continuous sound

Note: Ensure that voltage is not applied simultaneously between terminals 1, 2, and 3.

Precautions

■ Correct Use

Application Precautions

When power is supplied, there is an inrush current of up to 1 A. Confirm that this will not adversely affect operation or damage any devices before using the M2BJ in application. There is no inrush current with DC-only models (M2BJ-□□□-D).

Wiring

Perform soldering promptly and correctly at 30 W within 5 seconds or at a temperature of 240°C within 3 seconds. Wait for one minute after soldering before exerting any external force on the solder.

If flux is required, use non-corrosive rosin liquid. Ensure that the flux does not penetrate the inside of the case.

In order to improve the reliability of the soldering and to prevent pattern burnout, loop the wire through the terminal hole before soldering.

In order to fit the terminal holes, use lead wires with a nominal cross-sectional area of 0.25 mm² max.

Operating Environment

Do not use the Buzzer in environments where foreign substances may enter the sound outlet. Otherwise, the Buzzer may not sound.

Short-circuiting Jumper (M2BJ-BTH)

The Buzzer sounds continuously or intermittently depending on how the short-circuiting bracket is attached to the case guide. When the bracket is attached with the triangle on it facing direction A (PC board side), the Buzzer sounds intermittently.

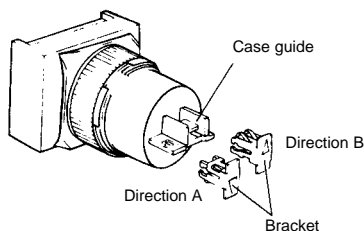

To produce continuous sounds, attach the bracket to the case guide so that the triangle on the bracket faces direction B.

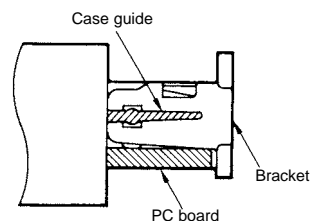

Volume Adjustment Mechanism (M2BJ-BH Only)

Adjust the volume by turning the control knob on the face of the Buzzer using a screwdriver. Turn to the right to increase the volume and turn to the left to decrease the volume.

Turn the control knob with a torque of 0.98 to 2.94 mN·m.

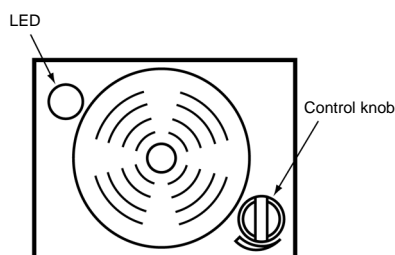

ALL DIMENSIONS SHOWN ARE IN MILLIMETERS.

To convert millimeters into inches, multiply by 0.03937. To convert grams into ounces, multiply by 0.03527.

Pushbutton Switch A22

Install in 22-dia. or 25-dia. Panel Cutout

- Easy mounting and removal of Switch Unit.
- Increase wiring efficiency with three-row mounting of Switch Blocks.
- Finger protection mechanism on Switch Unit provided as a standard feature.
- Use 25-dia. ring to install in 25-dia. panel cutouts.
- Mounted using either open-type (fork-type) or closed-type (round-type) crimp terminals.
- Wide range of shapes and colors.
- IP65 oil resistance (non-lighted models)
IP65 (lighted models)
- EN60947-5-1
- UL and cUL approved (File No. E41515)



Model Number Structure

Model Number Legend

Completely Assembled

Shipped as a set which includes the Pushbutton, Lamp (lighted type only), and Switch.

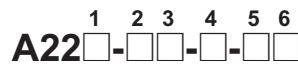

1 Lighted/Non-lighted

Code	Description
No symbol	Non-lighted
L	Lighted

2 Flange Shape

Non-lighted	
Code	Description
F	Round/Flat
T	Round/Projection
G	Round/Full-guard
H	Round/Half-guard
C	Square/Projection
D	Square/Full-guard
S	Round/Mushroom (30-dia. head)
M	Round/Mushroom (40-dia. head)
Lighted	
T	Round/Projection
G	Round/Full-guard
H	Round/Half-guard
C	Square/Projection
D	Square/Full-guard

3 Illumination Color

Code	Description
R	Red
G	Green
Y	Yellow
W	White
A	Blue
B	Black (for non-lighted type only)

4 Light Source

Without Voltage Reduction Unit		
Code	Operating Voltage	
No symbol	Non-lighted	
6D	LED	6 VDC
6A		6 VAC
12A		12 VAC/VDC
24A		24 VAC/VDC
5	Incandescent lamp	5 VAC/VDC
12		12 VAC/VDC
24		24 VAC/VDC
H1		100 VAC/VDC
With Voltage Reduction Unit		
T1	LED	100 VAC (See note 1)
T2		200 VAC (See note 2)

5 Contacts

Code	Description
10	SPST-NO
01	SPST-NC
11	SPST-NO + SPST-NC
20	DPST-NO
02	DPST-NC

Note: Refer to page 149 for contact ratings.

6 Switch Action

Code	Description
M	Momentary
A	Alternate

- Note:**
- Operational voltage: 95 to 115 VAC
 - Operational voltage: 190 to 230 VAC
 - The LED lamp (24 VAC/VDC) can be lit by directly applying 100 VAC/VDC (200 VAC/VDC) to the lamp terminal.
 - LED incorporates the 24-VAC/VDC type to the Voltage Reduction Unit models.

Subassembled

The Pushbutton, Lamp, or Switch can be ordered separately. Use them in combination for models that are not available as assembled Units. These can also be used as inventory for maintenance parts.

1. Pushbutton

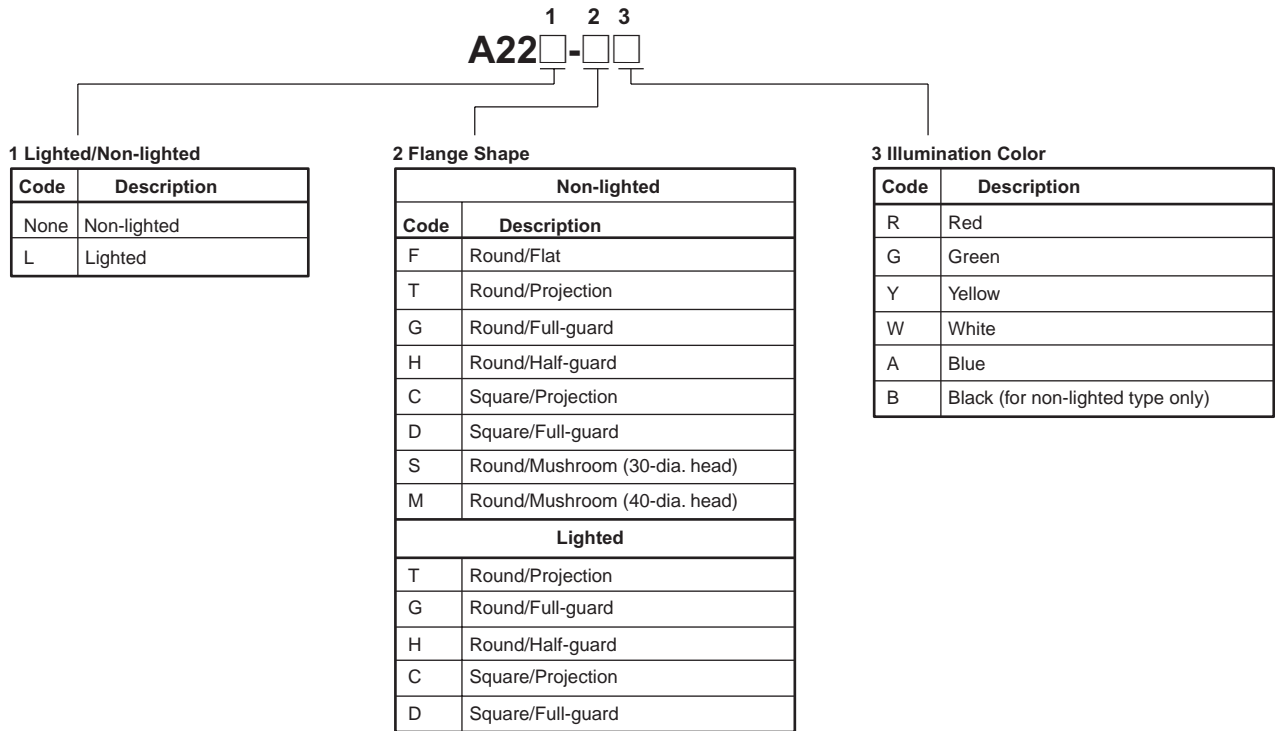

2. Lamp

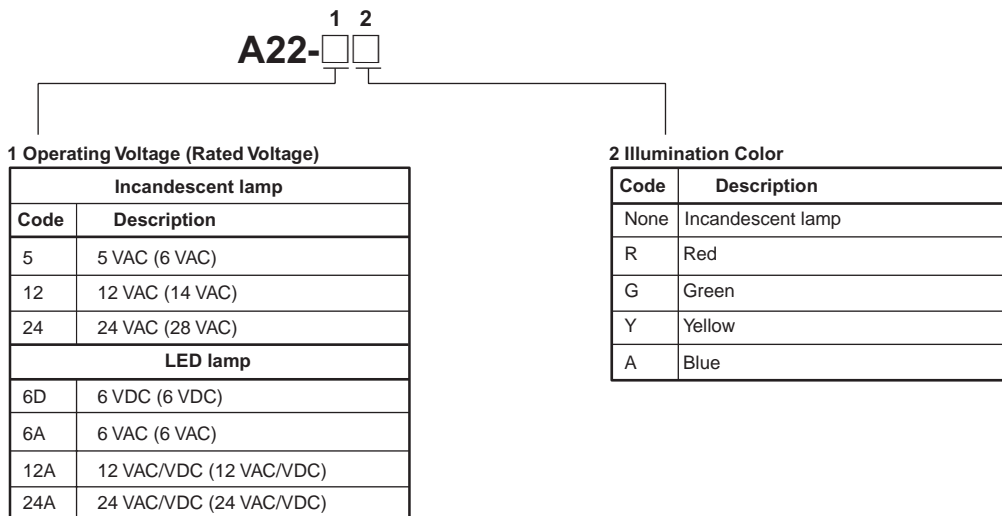

3. Switch (Standard Load)

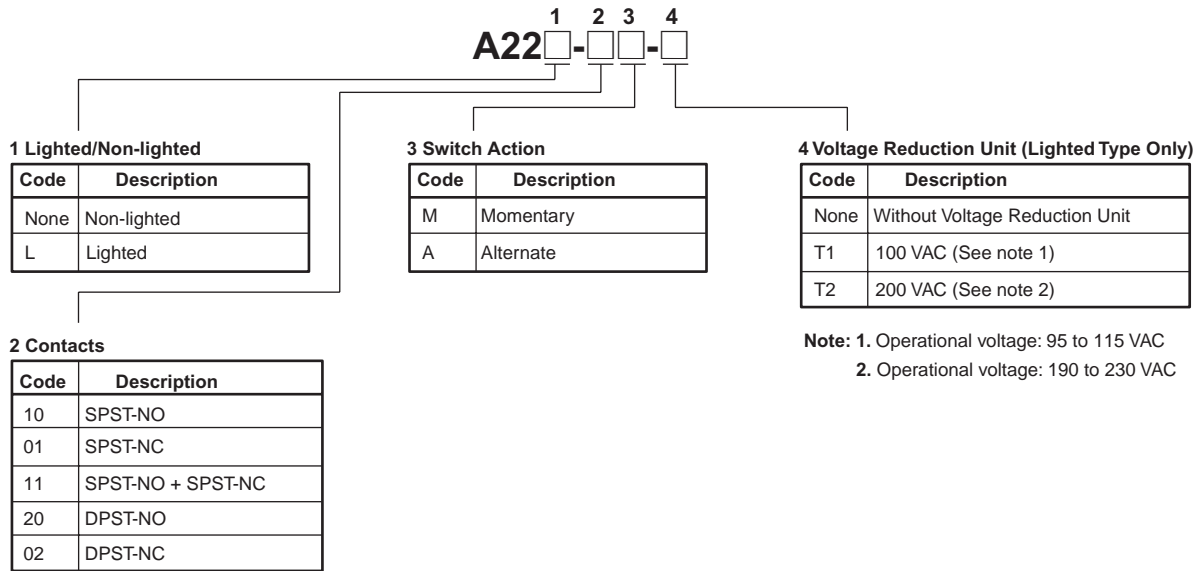

Ordering Information

■ List of Models

Ordering as a Set

Non-lighted (Round Type)

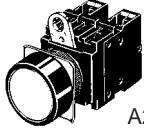
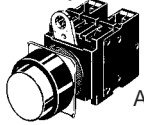
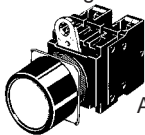
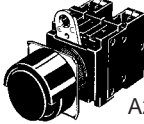
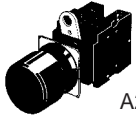
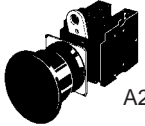
Appearance	Output	Momentary operation (self-resetting)	Alternate operation (self-holding)	Illumination color
Round/Flat type  A22-F	SPST-NO	A22-F□-10M	A22-F□-10A	Insert one of the following letters into the box □. R (red) Y (yellow) G (green) W (white) A (blue) B (black)
	SPST-NC	A22-F□-01M	A22-F□-01A	
	SPST-NO + SPST-NC	A22-F□-11M	A22-F□-11A	
	DPST-NO	A22-F□-20M	A22-F□-20A	
	DPST-NC	A22-F□-02M	A22-F□-02A	
Round/Projection type  A22-T	SPST-NO	A22-T□-10M	A22-T□-10A	
	SPST-NC	A22-T□-01M	A22-T□-01A	
	SPST-NO + SPST-NC	A22-T□-11M	A22-T□-11A	
	DPST-NO	A22-T□-20M	A22-T□-20A	
	DPST-NC	A22-T□-02M	A22-T□-02A	
Round/Full-guard type  A22-G	SPST-NO	A22-G□-10M	A22-G□-10A	
	SPST-NC	A22-G□-01M	A22-G□-01A	
	SPST-NO + SPST-NC	A22-G□-11M	A22-G□-11A	
	DPST-NO	A22-G□-20M	A22-G□-20A	
	DPST-NC	A22-G□-02M	A22-G□-02A	
Round/Half-guard type  A22-H	SPST-NO	A22-H□-10M	A22-H□-10A	
	SPST-NC	A22-H□-01M	A22-H□-01A	
	SPST-NO + SPST-NC	A22-H□-11M	A22-H□-11A	
	DPST-NO	A22-H□-20M	A22-H□-20A	
	DPST-NC	A22-H□-02M	A22-H□-02A	
Round/Small-size Mushroom type (30-dia. head)  A22-S	SPST-NO	A22-S□-10M	---	
	SPST-NC	A22-S□-01M		
	SPST-NO + SPST-NC	A22-S□-11M		
	DPST-NO	A22-S□-20M		
	DPST-NC	A22-S□-02M		
Round/Medium-size Mushroom type (40-dia head)  A22-M	SPST-NO	A22-M□-10M		
	SPST-NC	A22-M□-01M		
	SPST-NO + SPST-NC	A22-M□-11M		
	DPST-NO	A22-M□-20M		
	DPST-NC	A22-M□-02M		

Non-lighted (Square Type)

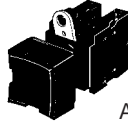

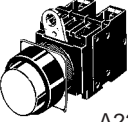
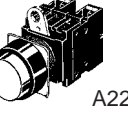
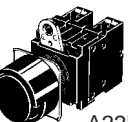

Appearance	Output	Momentary operation (self-reset)	Alternate operation (self-holding)	Illumination color
Square/Projection type  A22-C	SPST-NO	A22-C□-10M	A22-C□-10A	Insert one of the following letters into the box □. R (red) Y (yellow) G (green) W (white) A (blue) B (black)
	SPST-NC	A22-C□-01M	A22-C□-01A	
	SPST-NO + SPST-NC	A22-C□-11M	A22-C□-11A	
	DPST-NO	A22-C□-20M	A22-C□-20A	
	DPST-NC	A22-C□-02M	A22-C□-02A	
Square/Guard type  A22-D	SPST-NO	A22-D□-10M	A22-D□-10A	
	SPST-NC	A22-D□-01M	A22-D□-01A	
	SPST-NO + SPST-NC	A22-D□-11M	A22-D□-11A	
	DPST-NO	A22-D□-20M	A22-D□-20A	
	DPST-NC	A22-D□-02M	A22-D□-02A	

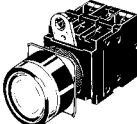
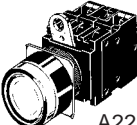
Lighted (Round Type)

Appearance	Output	Lighting	Operating voltage	Momentary operation (self-resetting)	Alternate operation (self-holding)	Illumination color
Round/Projection type LED lighting (without Voltage Reduction Unit)  A22L-T	SPST-NO	LED	6 VDC	A22L-T□-6D-10M	A22L-T□-6D-10A	Insert one of the following letters into the box □. R (red) Y (yellow) G (green) W (white) A (blue)
			6 VAC	A22L-T□-6A-10M	A22L-T□-6A-10A	
			12 VAC/VDC	A22L-T□-12A-10M	A22L-T□-12A-10A	
			24 VAC/VDC	A22L-T□-24A-10M	A22L-T□-24A-10A	
	SPST-NC		6 VDC	A22L-T□-6D-01M	A22L-T□-6D-01A	
			6 VAC	A22L-T□-6A-01M	A22L-T□-6A-01A	
			12 VAC/VDC	A22L-T□-12A-01M	A22L-T□-12A-01A	
			24 VAC/VDC	A22L-T□-24A-01M	A22L-T□-24A-01A	
	SPST-NO + SPST-NC		6 VDC	A22L-T□-6D-11M	A22L-T□-6D-11A	
			6 VAC	A22L-T□-6A-11M	A22L-T□-6A-11A	
			12 VAC/VDC	A22L-T□-12A-11M	A22L-T□-12A-11A	
			24 VAC/VDC	A22L-T□-24A-11M	A22L-T□-24A-11A	
	DPST-NO		6 VDC	A22L-T□-6D-20M	A22L-T□-6D-20A	
			6 VAC	A22L-T□-6A-20M	A22L-T□-6A-20A	
			12 VAC/VDC	A22L-T□-12A-20M	A22L-T□-12A-20A	
			24 VAC/VDC	A22L-T□-24A-20M	A22L-T□-24A-20A	
DPST-NC	6 VDC	A22L-T□-6D-02M	A22L-T□-6D-02A			
	6 VAC	A22L-T□-6A-02M	A22L-T□-6A-02A			
	12 VAC/VDC	A22L-T□-12A-02M	A22L-T□-12A-02A			
	24 VAC/VDC	A22L-T□-24A-02M	A22L-T□-24A-02A			
Round/Projection type LED voltage-reduction lighting (with Voltage Reduction Unit)  A22L-T	SPST-NO	100 VAC	A22L-T□-T1-10M	A22L-T□-T1-10A		
		200 VAC	A22L-T□-T2-10M	A22L-T□-T2-10A		
	SPST-NC	100 VAC	A22L-T□-T1-01M	A22L-T□-T1-01A		
		200 VAC	A22L-T□-T2-01M	A22L-T□-T2-01A		
	SPST-NO + SPST-NC	100 VAC	A22L-T□-T1-11M	A22L-T□-T1-11A		
		200 VAC	A22L-T□-T2-11M	A22L-T□-T2-11A		
	DPST-NO	100 VAC	A22L-T□-T1-20M	A22L-T□-T1-20A		
		200 VAC	A22L-T□-T2-20M	A22L-T□-T2-20A		
DPST-NC	100 VAC	A22L-T□-T1-02M	A22L-T□-T1-02A			
	200 VAC	A22L-T□-T2-02M	A22L-T□-T2-02A			
Round/Half-guard type LED lighting (without Voltage Reduction Unit)  A22L-H	SPST-NO	24 VAC/VDC	A22L-H□-24A-10M	A22L-H□-24A-10A		
	SPST-NC		A22L-H□-24A-01M	A22L-H□-24A-01A		
	SPST-NO + SPST-NC		A22L-H□-24A-11M	A22L-H□-24A-11A		
	DPST-NO		A22L-H□-24A-20M	A22L-H□-24A-20A		
	DPST-NC		A22L-H□-24A-02M	A22L-H□-24A-02A		

Appearance	Output	Lighting	Operating voltage	Momentary operation (self-resetting)	Alternate operation (self-holding)	Illumination color
Round/Half-guard type LED voltage-reduction lighting (with Voltage Reduction Unit)  A22L-H	SPST-NO	LED	100 VAC	A22L-H□-T1-10M	A22L-H□-T1-10A	Insert one of the following letters into the box □. R (red) Y (yellow) G (green) W (white) A (blue)
			200 VAC	A22L-H□-T2-10M	A22L-H□-T2-10A	
	SPST-NC		100 VAC	A22L-H□-T1-01M	A22L-H□-T1-01A	
			200 VAC	A22L-H□-T2-01M	A22L-H□-T2-01A	
	SPST-NO + SPST-NC		100 VAC	A22L-H□-T1-11M	A22L-H□-T1-11A	
			200 VAC	A22L-H□-T2-11M	A22L-H□-T2-11A	
	DPST-NO		100 VAC	A22L-H□-T1-20M	A22L-H□-T1-20A	
			200 VAC	A22L-H□-T2-20M	A22L-H□-T2-20A	
	DPST-NC		100 VAC	A22L-H□-T1-02M	A22L-H□-T1-02A	
			200 VAC	A22L-H□-T2-02M	A22L-H□-T2-02A	
Round/Full-guard type LED lighting (without Voltage Reduction Unit)  A22L-G	SPST-NO	6 VDC	A22L-G□-6D-10M	A22L-G□-6D-10A		
		6 VAC	A22L-G□-6A-10M	A22L-G□-6A-10A		
		12 VAC/VDC	A22L-G□-12A-10M	A22L-G□-12A-10A		
		24 VAC/VDC	A22L-G□-24A-10M	A22L-G□-24A-10A		
	SPST-NC	6 VDC	A22L-G□-6D-01M	A22L-G□-6D-01A		
		6 VAC	A22L-G□-6A-01M	A22L-G□-6A-01A		
		12 VAC/VDC	A22L-G□-12A-01M	A22L-G□-12A-01A		
		24 VAC/VDC	A22L-G□-24A-01M	A22L-G□-24A-01A		
	SPST-NO + SPST-NC	6 VDC	A22L-G□-6D-11M	A22L-G□-6D-11A		
		6 VAC	A22L-G□-6A-11M	A22L-G□-6A-11A		
		12 VAC/VDC	A22L-G□-12A-11M	A22L-G□-12A-11A		
		24 VAC/VDC	A22L-G□-24A-11M	A22L-G□-24A-11A		
	DPST-NO	6 VDC	A22L-G□-6D-20M	A22L-G□-6D-20A		
		6 VAC	A22L-G□-6A-20M	A22L-G□-6A-20A		
		12 VAC/VDC	A22L-G□-12A-20M	A22L-G□-12A-20A		
		24 VAC/VDC	A22L-G□-24A-20M	A22L-G□-24A-20A		
	DPST-NC	6 VDC	A22L-G□-6D-02M	A22L-G□-6D-02A		
		6 VAC	A22L-G□-6A-02M	A22L-G□-6A-02A		
		12 VAC/VDC	A22L-G□-12A-02M	A22L-G□-12A-02A		
		24 VAC/VDC	A22L-G□-24A-02M	A22L-G□-24A-02A		
Round/Full-guard type LED voltage-reduction lighting (with Voltage Reduction Unit)  A22L-G	SPST-NO	100 VAC	A22L-G□-T1-10M	A22L-G□-T1-10A		
		200 VAC	A22L-G□-T2-10M	A22L-G□-T2-10A		
	SPST-NC	100 VAC	A22L-G□-T1-01M	A22L-G□-T1-01A		
		200 VAC	A22L-G□-T2-01M	A22L-G□-T2-01A		
	SPST-NO + SPST-NC	100 VAC	A22L-G□-T1-11M	A22L-G□-T1-11A		
		200 VAC	A22L-G□-T2-11M	A22L-G□-T2-11A		
	DPST-NO	100 VAC	A22L-G□-T1-20M	A22L-G□-T1-20A		
		200 VAC	A22L-G□-T2-20M	A22L-G□-T2-20A		
	DPST-NC	100 VAC	A22L-G□-T1-02M	A22L-G□-T1-02A		
		200 VAC	A22L-G□-T2-02M	A22L-G□-T2-02A		

Lighted (Square Type)



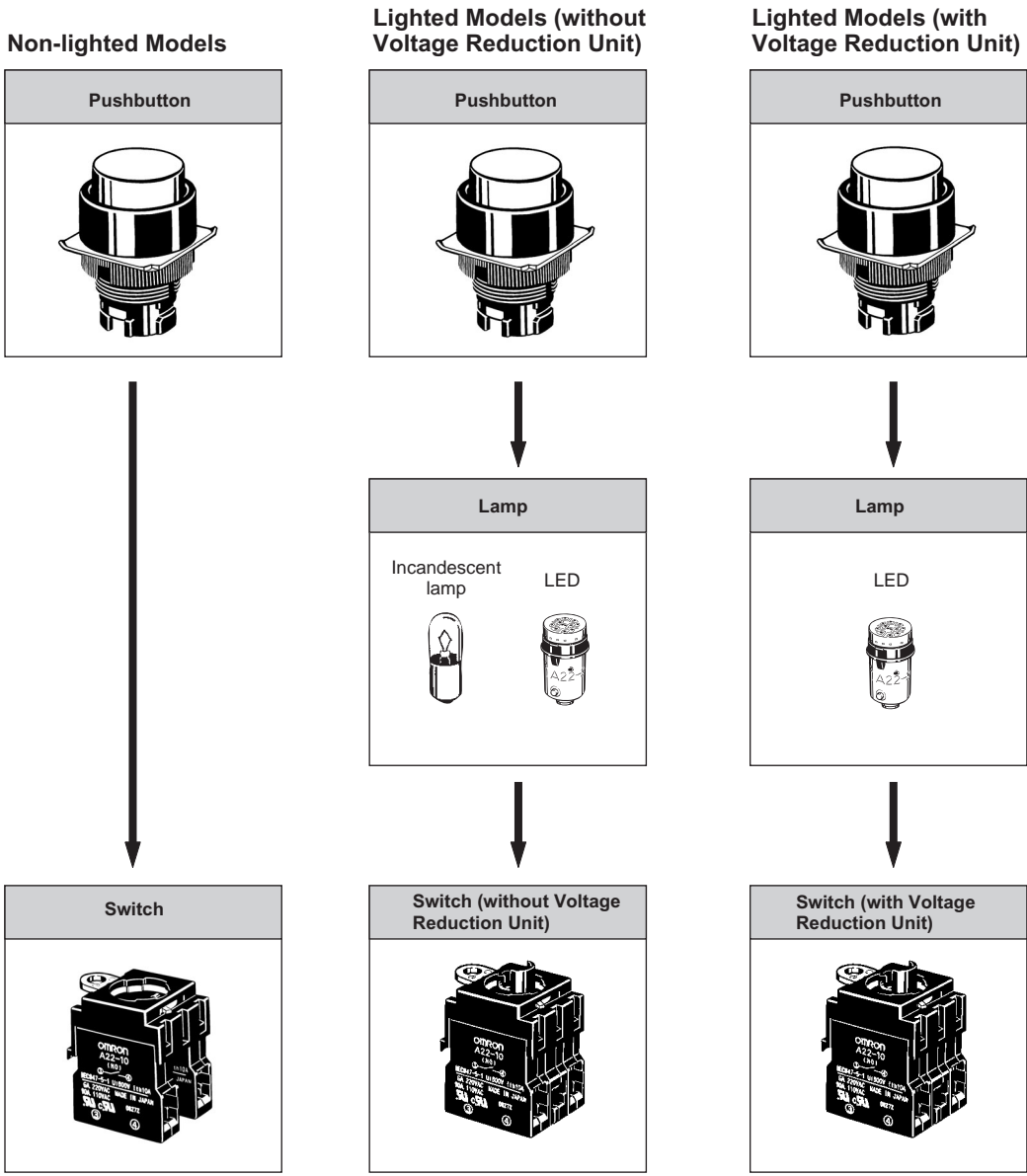

Appearance	Output	Lighting	Operating voltage	Momentary operation (self-resetting)	Alternate operation (self-holding)	Illumination color
Square/Projection type LED lighting (without Voltage Reduction Unit)  A22L-C	SPST-NO	LED	24 VAC/VDC	A22L-C□-24A-10M	A22L-C□-24A-10A	Insert one of the following letters into the box □. R (red) Y (yellow) G (green) W (white) A (blue)
	SPST-NC			A22L-C□-24A-01M	A22L-C□-24A-01A	
	SPST-NO + SPST-NC			A22L-C□-24A-11M	A22L-C□-24A-11A	
	DPST-NO			A22L-C□-24A-20M	A22L-C□-24A-20A	
	DPST-NC			A22L-C□-24A-02M	A22L-C□-24A-02A	
Square/Projection type LED voltage-reduction lighting (with Voltage Reduction Unit)  A22L-C	SPST-NO		100 VAC	A22L-C□-T1-10M	A22L-C□-T1-10A	
	SPST-NC		200 VAC	A22L-C□-T2-10M	A22L-C□-T2-10A	
			100 VAC	A22L-C□-T1-01M	A22L-C□-T1-01A	
	SPST-NO + SPST-NC		200 VAC	A22L-C□-T2-01M	A22L-C□-T2-01A	
			100 VAC	A22L-C□-T1-11M	A22L-C□-T1-11A	
	DPST-NO	200 VAC	A22L-C□-T2-11M	A22L-C□-T2-11A		
		100 VAC	A22L-C□-T1-20M	A22L-C□-T1-20A		
	DPST-NC	200 VAC	A22L-C□-T2-20M	A22L-C□-T2-20A		
		100 VAC	A22L-C□-T1-02M	A22L-C□-T1-02A		
	200 VAC	A22L-C□-T2-02M	A22L-C□-T2-02A			
Square/Full-guard type LED lighting (without Voltage Reduction Unit)  A22L-D	SPST-NO	24 VAC/VDC		A22L-D□-24A-10M	A22L-D□-24A-10A	
	SPST-NC			A22L-D□-24A-01M	A22L-D□-24A-01A	
	SPST-NO + SPST-NC			A22L-D□-24A-11M	A22L-D□-24A-11A	
	DPST-NO			A22L-D□-24A-20M	A22L-D□-24A-20A	
	DPST-NC			A22L-D□-24A-02M	A22L-D□-24A-02A	
Square/Full-guard type LED voltage-reduction lighting (with Voltage Reduction Unit)  A22L-D	SPST-NO		100 VAC	A22L-D□-T1-10M	A22L-D□-T1-10A	
	SPST-NC		200 VAC	A22L-D□-T2-10M	A22L-D□-T2-10A	
			100 VAC	A22L-D□-T1-01M	A22L-D□-T1-01A	
	SPST-NO + SPST-NC		200 VAC	A22L-D□-T2-01M	A22L-D□-T2-01A	
			100 VAC	A22L-D□-T1-11M	A22L-D□-T1-11A	
	DPST-NO	200 VAC	A22L-D□-T2-11M	A22L-D□-T2-11A		
		100 VAC	A22L-D□-T1-20M	A22L-D□-T1-20A		
	DPST-NC	200 VAC	A22L-D□-T2-20M	A22L-D□-T2-20A		
		100 VAC	A22L-D□-T1-02M	A22L-D□-T1-02A		
	200 VAC	A22L-D□-T2-02M	A22L-D□-T2-02A			





Ordering Individually





Pushbutton

Non-lighted

Color	IP65 oil-resistant models			
	Flat type 	Projection type 	Full-guard type 	Half-guard type 
Red	A22-FR	A22-TR	A22-GR	A22-HR
Green	A22-FG	A22-TG	A22-GG	A22-HG
Yellow	A22-FY	A22-TY	A22-GY	A22-HY
White	A22-FW	A22-TW	A22-GW	A22-HW
Blue	A22-FA	A22-TA	A22-GA	A22-HA
Black	A22-FB	A22-TB	A22-GB	A22-HB

Color	IP65 oil-resistant models			
	Square/Projection type 	Square/Full-guard type 	Round/Mushroom type (30-dia. head) 	Round/Mushroom type (40-dia. head) 
Red	A22-CR	A22-DR	A22-SR	A22-MR
Green	A22-CG	A22-DG	A22-SG	A22-MG
Yellow	A22-CY	A22-DY	A22-SY	A22-MY
White	A22-CW	A22-DW	A22-SW	A22-MW
Blue	A22-CA	A22-DA	A22-SA	A22-MA
Black	A22-CB	A22-DB	A22-SB	A22-MB

Lighted

Color	IP65		
	Projection type 	Full-guard type 	Half-guard type 
Red	A22L-TR	A22L-GR	A22L-HR
Green	A22L-TG	A22L-GG	A22L-HG
Yellow	A22L-TY	A22L-GY	A22L-HY
White	A22L-TW	A22L-GW	A22L-HW
Blue	A22L-TA	A22L-GA	A22L-HA

Note: Common to incandescent lamps and LED lamps.

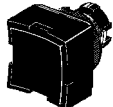
Color	IP65	
	Square/Projection 	Square/Full-guard type 
Red	A22L-CR	A22L-DR
Green	A22L-CG	A22L-DG
Yellow	A22L-CY	A22L-DY
White	A22L-CW	A22L-DW
Blue	A22L-CA	A22L-DA

Lamp

LED Lamp

Appearance	Operating voltage		6 V	12 V	24 V	24 V Super-bright
	AC/DC	LED light	Model			
	DC	Red	A22-6DR	---	---	---
		Green	A22-6DG	---	---	---
		Yellow (See note 2.)	A22-6DY	---	---	---
		Blue	A22-6DA	---	---	---
	AC	Red	A22-6AR	---	---	---
		Green	A22-6AG	---	---	---
		Yellow (See note 2.)	A22-6AY	---	---	---
		Blue	A22-6AA	---	---	---
	AC and DC	Red	---	A22-12AR	A22-24AR	A22-24ASR
		Green	---	A22-12AG	A22-24AG	A22-24ASG
		Yellow (See note 2.)	---	A22-12AY	A22-24AY	A22-24ASY
		Blue	---	A22-12AA	A22-24AA	A22-24ASA

- Note:** 1. For voltage-reduction lighting, use the A22-24A□.
 2. Used when the Pushbutton color is yellow or white.

Incandescent Lamp

Operating voltage	5 VAC/VDC	12 VAC/VDC	24 VAC/VDC
	A22-5	A22-12	A22-24

Switch (Standard Load)

Non-lighted

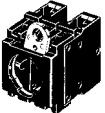
Switch operation	Contacts	Model
	SPST-NO	A22-10M
	SPST-NC	A22-01M
	SPST-NO + SPST-NC	A22-11M
	DPST-NO	A22-20M
	DPST-NC	A22-02M
	Alternate	SPST-NO
SPST-NC		A22-01A
SPST-NO + SPST-NC		A22-11A
DPST-NO		A22-20A
DPST-NC		A22-02A



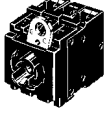
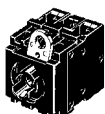
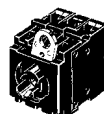



Lighted









Switch operation	Contacts	Voltage reduction circuits		
		Without Voltage Reduction Unit 	With Voltage Reduction Unit	
			110 VAC 	220 VAC 
Momentary	SPST-NO	A22L-10M	A22L-10M-T1	A22L-10M-T2
	SPST-NC	A22L-01M	A22L-01M-T1	A22L-01M-T2
	SPST-NO + SPST-NC	A22L-11M	A22L-11M-T1	A22L-11M-T2
	DPST-NO	A22L-20M	A22L-20M-T1	A22L-20M-T2
	DPST-NC	A22L-02M	A22L-02M-T1	A22L-02M-T2
Alternate	SPST-NO	A22L-10A	A22L-10A-T1	A22L-10A-T2
	SPST-NC	A22L-01A	A22L-01A-T1	A22L-01A-T2
	SPST-NO + SPST-NC	A22L-11A	A22L-11A-T1	A22L-11A-T2
	DPST-NO	A22L-20A	A22L-20A-T1	A22L-20A-T2
	DPST-NC	A22L-02A	A22L-02A-T1	A22L-02A-T2

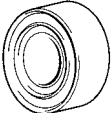
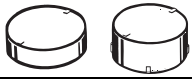



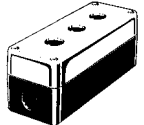

Note: 1. The above diagrams show the DPST-NO contact models as representative examples.
 2. For voltage-reduction lighting, use the A22-24A□.

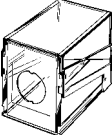
■ Accessories (Order Separately)

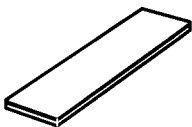
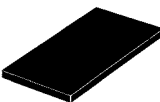
Common to A22, A22S/W, A22K, M22, and A22E

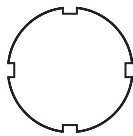
Item		Appearance	Classification		Model	Remarks
Switch Blocks			SPST-NO	Standard load	A22-10	Provided as standard. Order Switch Blocks only when adding or replacing them.
				Microload	A22-10S	
			SPST-NC	Standard load	A22-01	
				Microload	A22-01S	
			DPST-NO	Standard load	A22-20	
				Microload	A22-20S	
DPST-NC	Standard load	A22-02				
	Microload	A22-02S				
Lamp Sockets			Direct lighting		A22-TN	Used when changing the lighting method. (LED only)
			Voltage-reduction lighting	110 VAC	A22-T1	
				220 VAC	A22-T2	
Mounting Latches			For momentary models		A22-3200	Provided as standard. Order Mounting Latches only when mounting Switch Blocks or Lamp Sockets that are purchased individually.
			For alternate models		A22-3210	
Legend Plate Frames	Standard size		With Snap-in Legend Plate (Without text)	White	A22Z-3321	Snap-in Legend Plate is acrylic.
				Red	A22Z-3322	
				Black	A22Z-3323	
	Without Snap-in Legend Plate		A22Z-3320			
	Large size		With Snap-in Legend Plate (Without text)	White	A22Z-3331	
				Red	A22Z-3332	
Black		A22Z-3333				
Without Snap-in Legend Plate		A22Z-3330				
Lock Ring			Round		A22Z-3360	The body is equipped with a Lock Ring. This Lock Ring is used when a more secure lock feature is required.
Metallic Bezel Rings			For flat or projection models		A22Z-3580	Replace with the standard model. Material: nickel-plated zinc
			For full-guard models		A22Z-3582	

Item		Appearance	Classification		Model	Remarks
Sealing Caps			For flat models		A22Z-3600F	Used to prevent dust or water from entering the Operation Unit (Pushbutton, etc.). Color: opaque Material: silicon
			For projection models		A22Z-3600T	
			For full-guard models		A22Z-3600G	
Caps	A22	For A22 For M22 	For projection, full-guard, or half-guard models		A22Z-3490	Material: polycarbonate resin
	M22		For round models		A22Z-3495	
Color Caps			Red		A22Z-30TR	Used for changing the Pushbutton color of the (round) Pushbutton Switches.
			Green		A22Z-30TG	
			Yellow		A22Z-30TY	
			White		A22Z-30TW	
			Blue		A22Z-30TA	
Three-throw Spacer					A22Z-3003	Used when mounting three Non-lighted Switches. (See page 164.)
Hole Plug			Round		A22Z-3530	Can be plugged into pre-cut panel holes for future expansion. The color is black.
Control Boxes (Enclosures)			One hole	Exclusively for A22	A22Z-B101	For those designed exclusively for A22, DPST-NO or DPST-NC Switches cannot be used. Material: Polycarbonate resin
				Compatible with A3T	A22Z-B201	
			One hole, yellow box (for emergency stop)	Exclusively for A22	A22Z-B101Y	
				Compatible with A3T	A22Z-B201Y	
			Two holes	Exclusively for A22	A22Z-B102	
				Compatible with A3T	A22Z-B202	
			Three holes	Exclusively for A22	A22Z-B103	
Compatible with A3T	A22Z-B203					
Connectors			Applicable cable diameter (mm)	7 to 9 dia.	A22Z-3500-1	Plastic connector used to extend a cable from the Switch Box. (See page 162.)
				9 to 11 dia.	A22Z-3500-2	
25-dia. Ring			---		A22Z-R25	Use when mounting to a panel with a 25-dia. hole. For details, refer to page 153. Since this is not attached to the main body, order separately.
30-dia. Resin Attachment			Round		A22Z-A30	Use when mounting to a panel with a 30-dia. hole. For details, refer to page 155.
Lock Plate			---		A22Z-3380	Use to fix the lever on the Switch.
Simple Protective Cover			---		A11Z-3700	Prevents foreign matter entering into the Switch from the back of the panel.

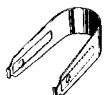
Item		Appearance	Classification		Model	Remarks	
Snap-in Legend Plates	Standard size		Without text	Black	A22Z-3443B	Attached to the Standard-size Legend Plate Frame. Material: Acrylic (See page 154.)	
				Red	A22Z-3443R		
				White	A22Z-3443W		
				Transparent	A22Z-3443C		
			White text on red background	m	A22Z-3443R-2		
				STOP	A22Z-3443R-4		
				White text on black background			A22Z-3443B-1
					START		A22Z-3443B-3
					ON		A22Z-3443B-5
					OFF		A22Z-3443B-6
	UP	A22Z-3443B-7					
	DOWN	A22Z-3443B-8					
	Large size		Without text	Black	A22Z-3453B		Attached to the Large-size Legend Plate Frame Material: Acrylic (See page 154.)
				Red	A22Z-3453R		
White				A22Z-3453W			
Transparent				A22Z-3453C			
For Emergency Stop Switch		60-dia. round plate with black letters on a yellow background	A22Z-3466-1		"EMERGENCY STOP" is engraved on the plate. Used as an Emergency Stop Switch Legend Plate		
		90-dia. round plate with black letters on a yellow background	A22Z-3476-1				
Character Films		No print (Round)	A22Z-3460		After printing on a film, affix to the indicator plate of the Lighted Pushbutton Switch. (The back is coated with adhesive.)		
		Character print (Round)		A22Z-3460-1			
			○	A22Z-3460-2			
			START	A22Z-3460-3			
			STOP	A22Z-3460-4			
No print (Square)	A22Z-3480						
Lamp Extractor		---	A22Z-3901		Rubber tool used to easily replace Lamps		
Tightening Wrench		---	A22Z-3905		Tool used to tighten nuts from the back of the panel		
Cap Tightening Tool		---	A22Z-3908		Used for replacing the cap of the Half-guard Pushbutton Switch.		
Cap Puller		---	A3PJ-5080		Used for removing the cap from the Pushbutton of the Square Lighted Pushbutton Switch.		

Specifications

Common to A22, A22S/W, A22K, and A22E

Approved Standards

Recognized organization	Standards	File No.
UL (See note.)	UL508	E41515
TÜV Product Service	EN60947-5-1	Inquire
CQC (CCC)	GB14048.5	2003010303070635

Note: UL-certification for CSA C22.2 No. 14 and bears the  mark.

Approved Standard Ratings

UL, cUL (File No. E41515)

6 A at 220 VAC, 10 A at 110 VAC

EN60947-5-1 (Low Voltage Directive)

3 A at 220 VAC

CCC (GB14048.5)

3 A at 240 VAC, 1.5 A at 24 VDC

Ratings

Contacts (Standard Load)

Rated carry current	Rated voltage	Rated current (A)			
		AC15 (inductive load)	AC12 (resistive load)	DC13 (inductive load)	DC12 (resistive load)
10	24 VAC	10	10	---	---
	110 VAC	5	10		
	220 VAC	3	6		
	380 VAC	2	3		
	440 VAC	1	2		
	24 VDC	---	---	1.5	10
	110 VDC			0.5	2
	220 VDC			0.2	0.6
	380 VDC			0.1	0.2

Note: 1. Rated current values are determined according to the testing conditions. The above ratings were obtained by conducting tests under the following conditions.

- (1) Ambient temperature: 20°±2°C
- (2) Ambient humidity: 65±5%
- (3) Operating frequency: 20 operations/minute

2. Minimum applicable load: 10 mA at 5 VDC

Contacts (Microload)

Rated applicable load	Minimum applicable load
50 mA at 24 VDC (Resistive load)	1 mA at 5 VDC

LED Indicators without Voltage Reduction Unit

Rated voltage	Rated current	Operating voltage
6 VDC	60 mA (20 mA)	6 VDC±5%
6 VAC	60 mA (20 mA)	6 VAC/VDC±5%
12 VAC/VDC	30 mA (10 mA)	12 VAC/VDC±5%
24 VAC/VDC	15 mA (10 mA)	24 VAC/VDC±5%

Note: Values in parentheses are for blue Pushbuttons.

Super-bright LED Indicator

Rated voltage	Rated current	Operating voltage
24 VAC/VDC	15 mA	24 VAC/VDC ±5%

Incandescent Lamp

Rated voltage	Rated current	Operating voltage
6 VAC/VDC	200 mA	5 VAC/VDC
14 VAC/VDC	80 mA	12 VAC/VDC
28 VAC/VDC	40 mA	24 VAC/VDC
130 VAC/VDC	20 mA	100 VAC/VDC

Voltage-reduction Lighting

Rated voltage	Operational voltage	Applicable lamp (BA8S/13□ gold)
110 VAC	95 to 115 VAC	LED Lamp (A22-24A□)
220 VAC	190 to 230 VAC	

■ Characteristics

Item		Pushbutton Switches		Emergency Stop Switches		Knob-type Selector Switches		Key-type Selector Switch
		Non-lighted models: A22-F A22-T A22-G A22-S A22-C A22-D A22-H A22-M	Lighted models: A22L-T A22L-G A22L-H A22L-D A22L-C	Non-lighted model: A22E	Lighted model: A22EL	Non-lighted model: A22S	Lighted model: A22W	Non-lighted model: A22K
Allowable operating frequency	Mechanical	Momentary operation: 60 operations/minute max.		30 operations/minute max.		Manual reset: 30 operations/minute max. Automatic reset: 30 operations/minute max.		
	Electrical	30 operations/minute max.				30 operations/minute max.		
Insulation resistance		100 MΩ min. (at 500 VDC)						
Dielectric strength		2,500 VAC, 50/60 Hz for 1 min between terminals of same polarity 2,500 VAC, 50/60 Hz for 1 min between terminals of different polarity and also between each terminal and ground						
Vibration resistance		Malfunction (See note 2.): 10 to 55 Hz, 1.5-mm double amplitude						
Shock resistance	Destruction	1,000 m/s ²	1,000 m/s ²	1,000 m/s ²		1,000 m/s ²	1,000 m/s ²	1,000 m/s ²
	Malfunction (See note 2.)	1,000 m/s ² max.	600 m/s ² max.	250 m/s ² max.		1,000 m/s ² max.	600 m/s ² max.	1,000 m/s ² max.
Durability	Mechanical	Momentary operation: 5,000,000 operations min.		300,000 operations min.		500,000 operations min.	100,000 operations min.	500,000 operations min.
	Electrical	500,000 operations min.		300,000 operations min.	300,000 operations min.	500,000 operations min.	100,000 operations min.	500,000 operations min.
Ambient temperature (See note 1.)		Operating: -20°C to 70°C Storage: -40°C to 70°C	Operating: -20°C to 55°C Storage: -40°C to 70°C	Operating: -20°C to 70°C Storage: -40°C to 70°C	Operating: -20°C to 55°C Storage: -40°C to 70°C	Operating: -20°C to 70°C Storage: -40°C to 70°C	Operating: -20°C to 55°C Storage: -40°C to 70°C	Operating: -20°C to 70°C Storage: -40°C to 70°C
Ambient humidity		Operating: 35% to 85%						
Degree of protection		IP65 (oil-resistant)	IP65	IP65 (oil-resistant)	IP65	IP65 (oil-resistant)	IP65	IP65 (oil-resistant)
Electric shock protection class		Class II						
PTI (tracking characteristic)		175						
Degree of contamination		3 (IEC947-5-1)						

- Note:** 1. With no icing or condensation.
2. Malfunction within 1 ms.

Operating Characteristics (for SPST-NO/SPST-NC)

Item	Pushbutton Switches	Emergency Stop Switches	Knob-type Selector Switches		Key-type Selector Switch	
	Lighted Non-lighted Pushbutton Switches	Push-lock turn-reset system	Manual reset	Automatic reset	Manual reset	Automatic reset
	A22-F A22-G A22-C A22-S A22-T A22-H A22-D A22-M A22L-T A22L-H A22L-D A22L-G A22L-C	A22E, A22EL	A22S, A22W	A22S, A22W	A22K	
Total travel force (TTF) max.	29.4 N	44.1 N	0.34 N·m (See note.)	0.25 N·m for two notches (See note.) 0.34 N·m for three notches (See note.)	0.34 N·m (See note.)	0.25 N·m for two notches (See note.) 0.34 N·m for three notches (See note.)
Total travel (TT)	5.5 mm max.	10±1 mm	Approx. 90° for two notches (Approx. 45° for three notches)		Approx. 90° for two notches (Approx. 45° for three notches)	
Resetting force (RF) min.	---	0.25 N·m max. (See note.)	0.34 N·m max. (See note.)	---	0.34 N·m max. (See note.)	---

Note: Rotation torque for Emergency Stop Pushbutton, Knob-type Selector, and Key-type Selector Switches.

Nomenclature

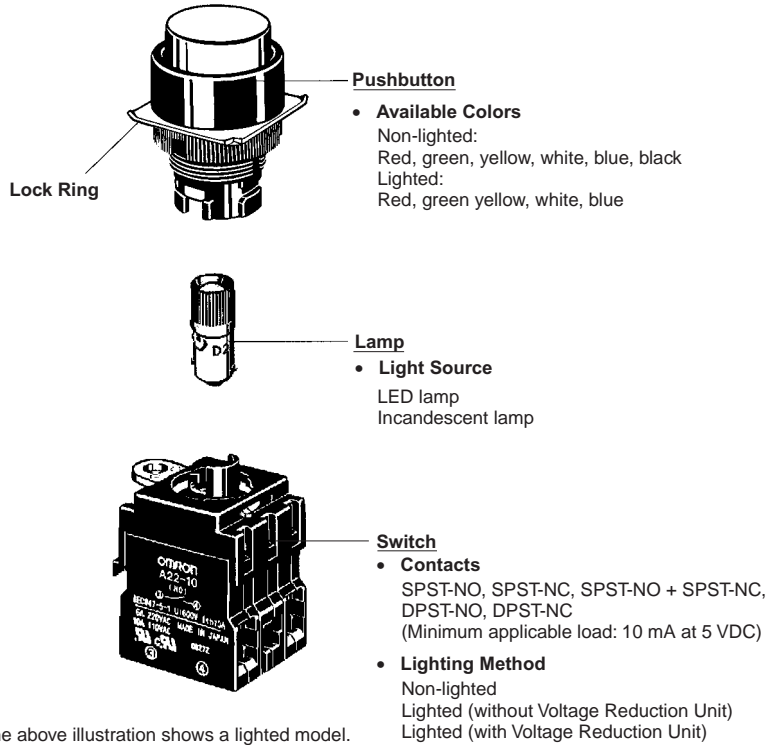

Dimensions

Note: 1. All units are in millimeters unless otherwise indicated.
 2. The following illustrations are for momentary operation.

Lighted/Non-lighted Pushbutton Switches

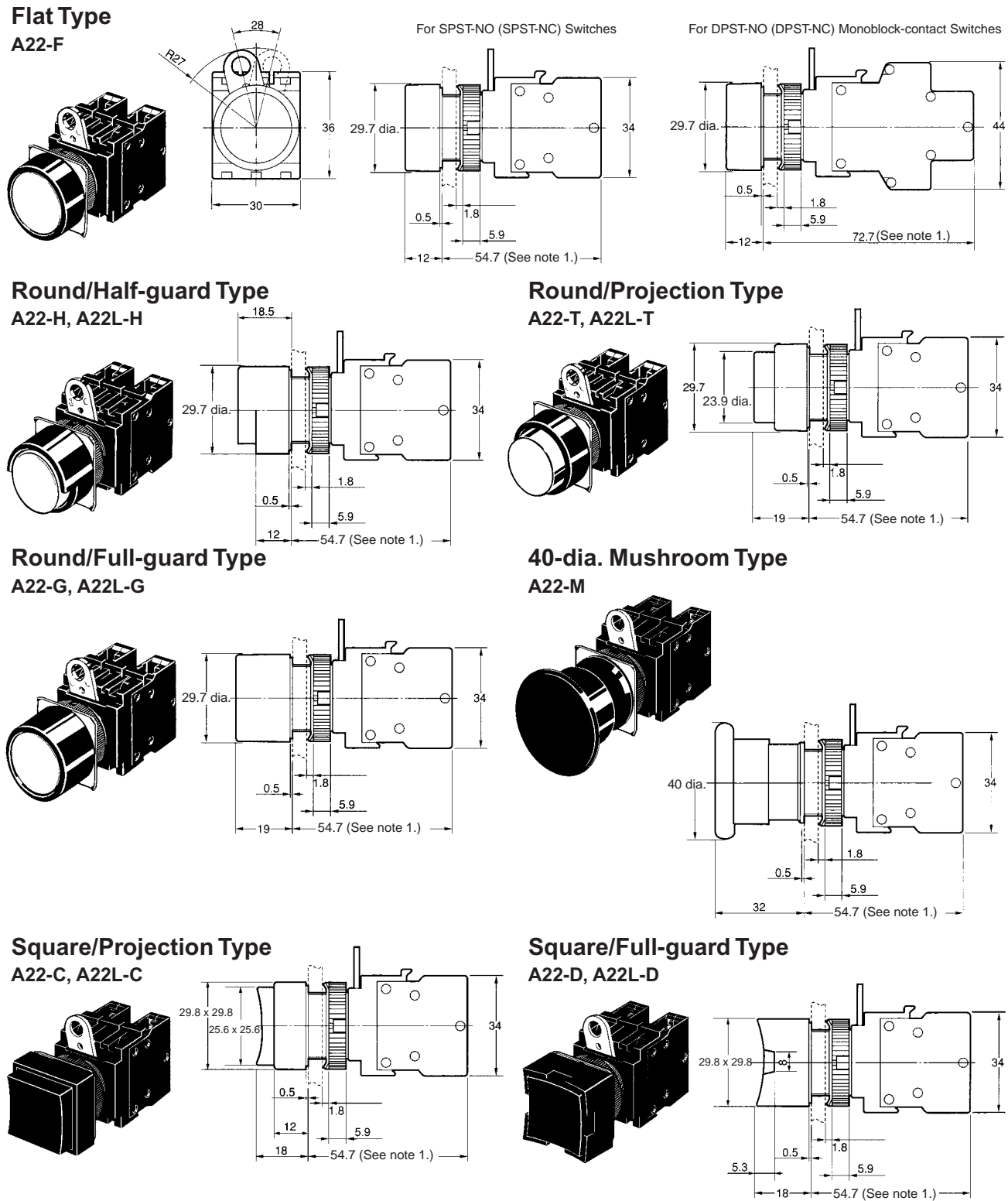

Note: 1. Alternate operation models are 9.3 mm longer.
 2. Lighted models have the same dimensions as shown above, whether they are with or without Voltage Reduction Units.

■ Accessories

Note: All units are in millimeters unless otherwise indicated.

Legend Plate Frames

A22Z-332□

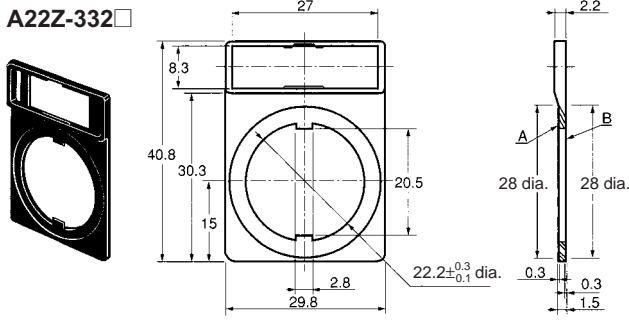

A22Z-333□

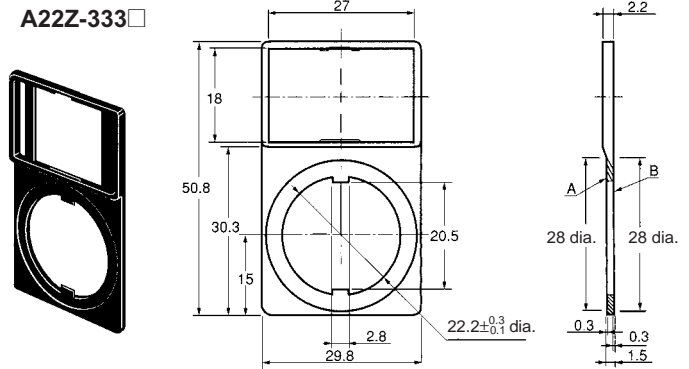

Lock Ring
A22Z-3360

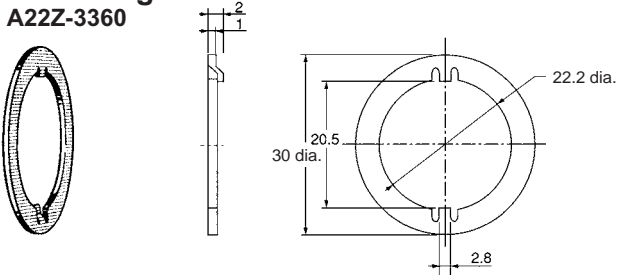

25-dia. Ring
A22Z-R25

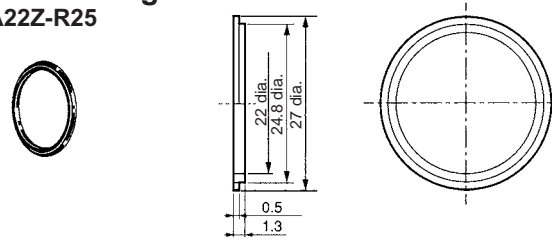

Color Cap
A22L-30T□

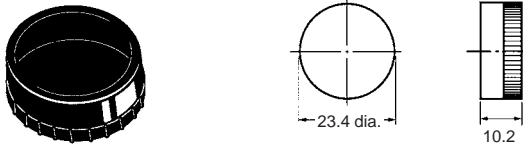

Hole Plug (Round)
A22Z-3530

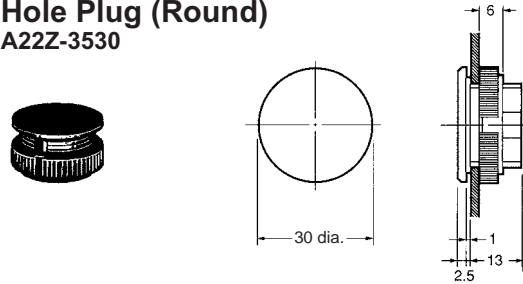

Sealing Caps

For Flat Models
A22Z-3600F

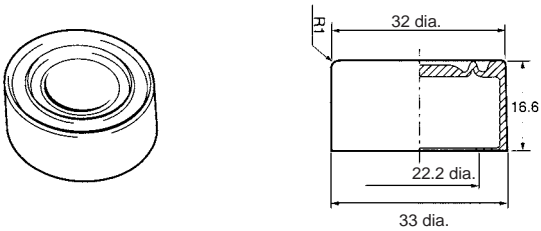

For Projection Models
A22Z-3600T

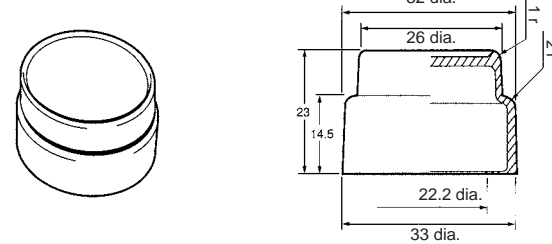

For Full-guard Models
A22Z-3600G

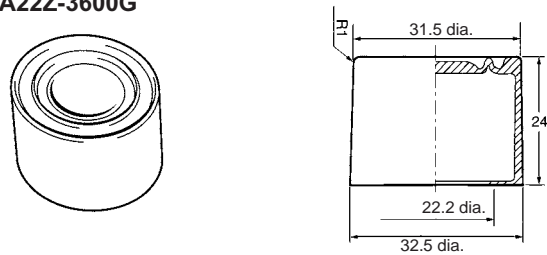

Three-throw Spacer

A22Z-3003

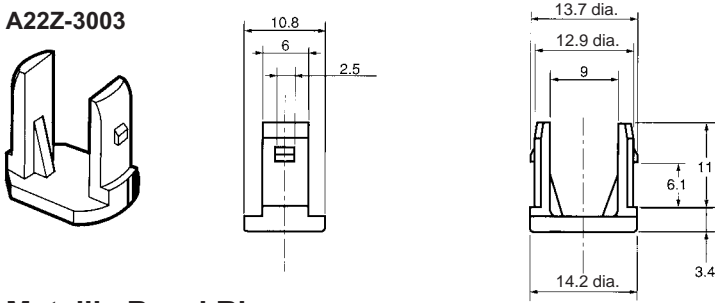

Metallic Bezel Rings

For Flat/Projection Models
A22Z-3580

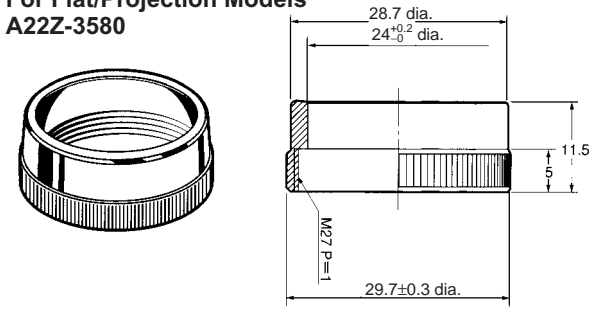

For Full-guard Models
A22Z-3582

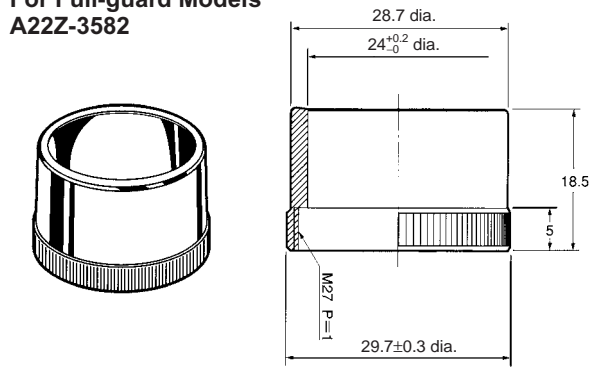

Snap-in Legend Plates

For Standard Models
A22Z-3443□-□

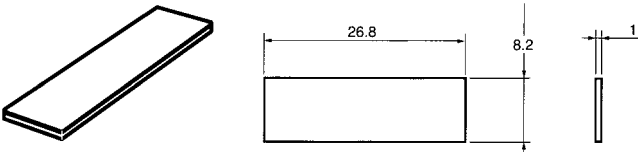

For Large Models
A22Z-3453□

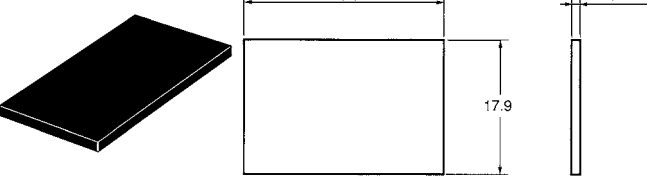

For Emergency-stop Models

A22Z-3476-1 (90 dia.)

A22Z-3466-1 (60 dia.)

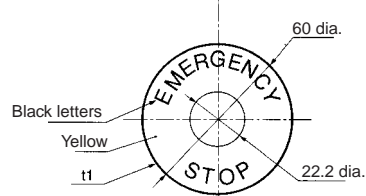
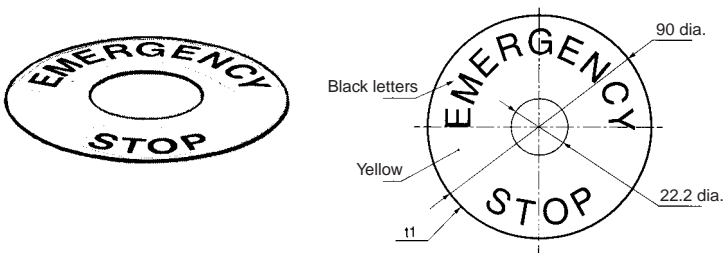

Character Film

For Round Models
A22Z-3460-□

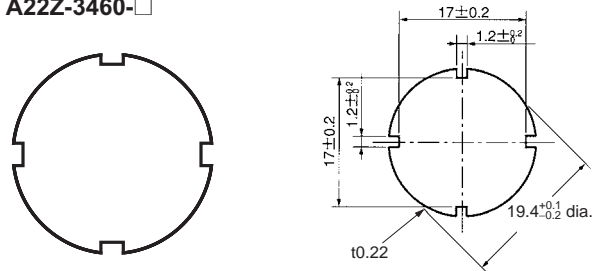

For Square Models
A22Z-3480

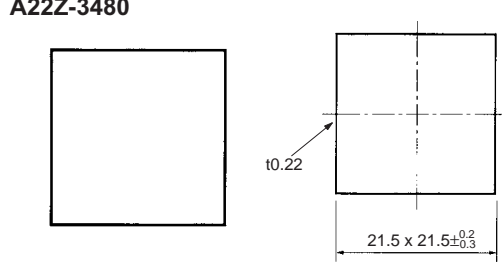

Lamp Extractor

A22Z-3901

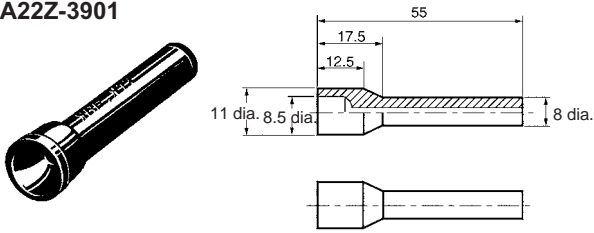

Tightening Wrench

A22Z-3905

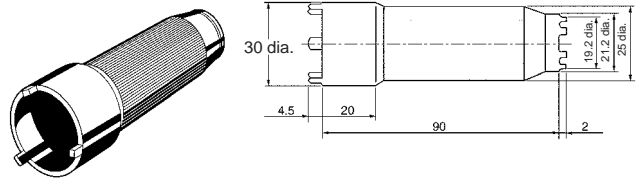

Cap Tightening Tool

A22Z-3908

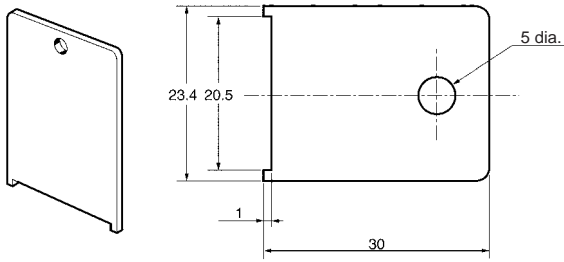

30-dia. Resin Attachment

A22Z-A30

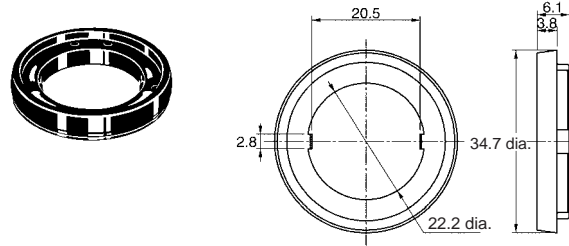

Cap Puller

A3PJ-5080

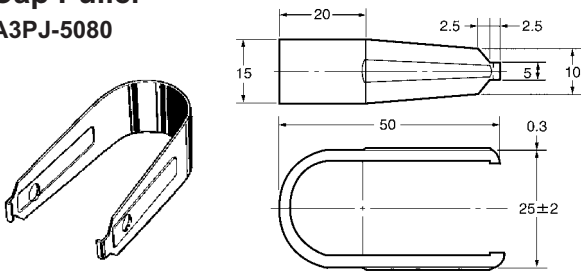

Lock Plate

A22Z-3380

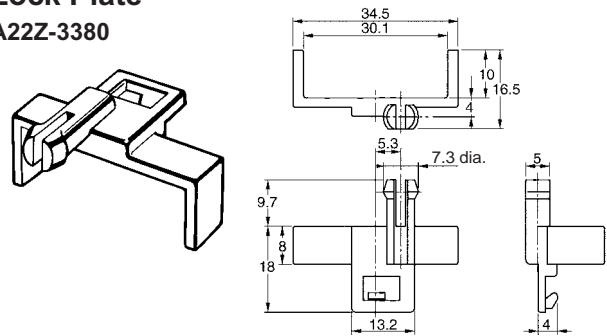

Simple Protective Cover

A22Z-3700

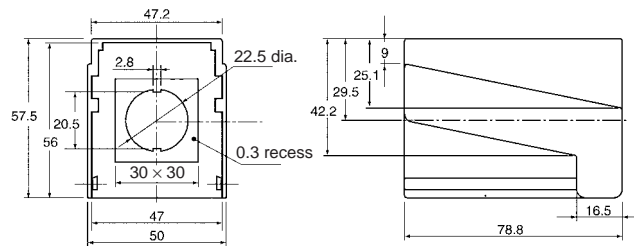
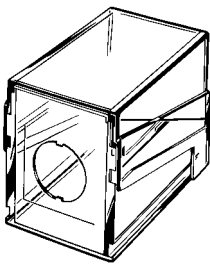

Control Box (Enclosure)

A22Z-B10□

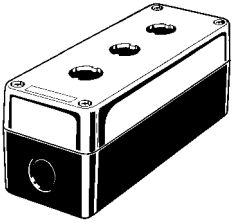

A22Z-B101 (One Hole)
A22Z-B101Y

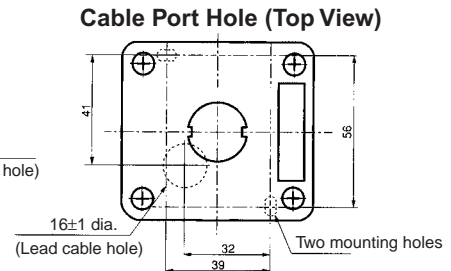
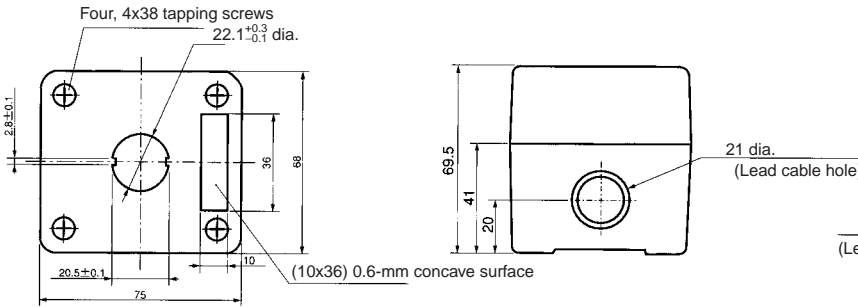

A22Z-B102 (Two Holes)

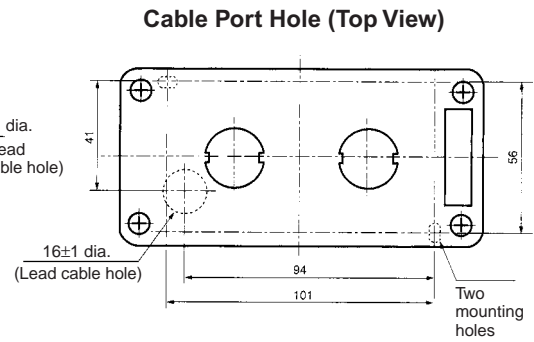
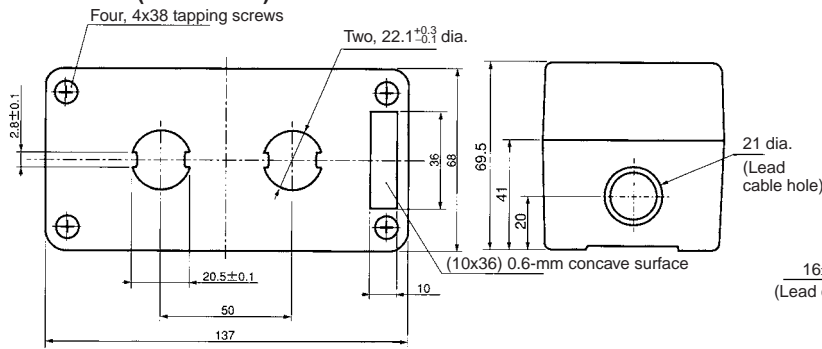

A22Z-B103 (Three Holes)

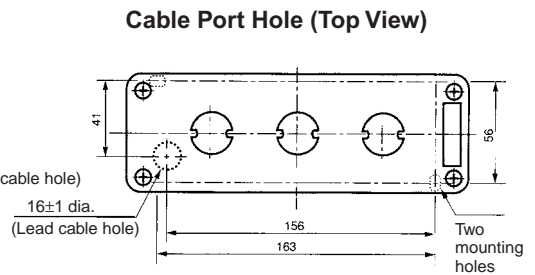
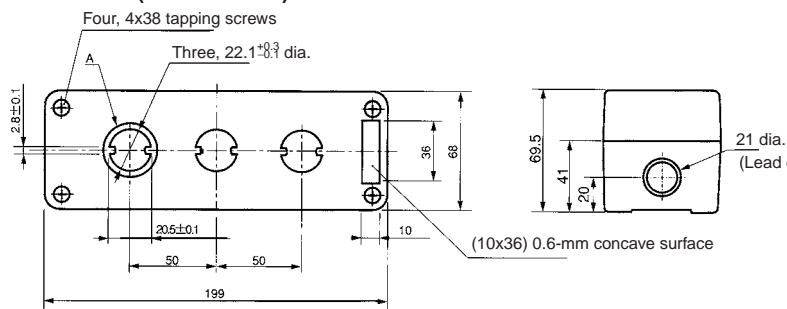

Panel Mounting Hole

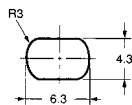

A22Z-B201 (One Hole)
A22Z-B201Y

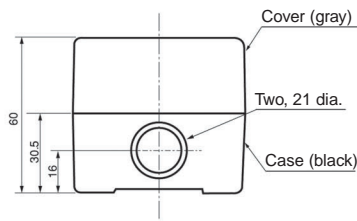
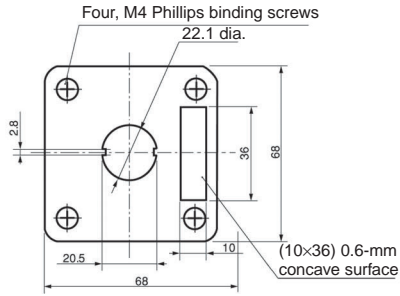

Cable Port Hole (Top View)

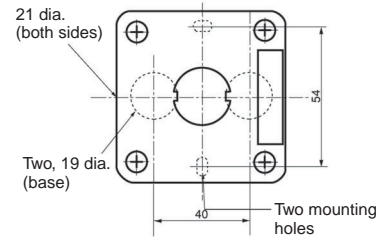

A22Z-B202 (Two Holes)

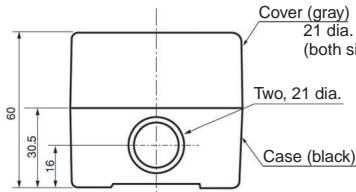
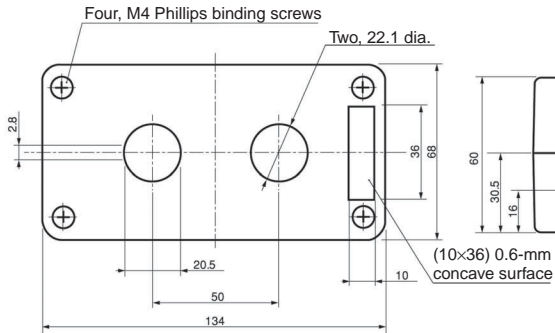

Cable Port Hole (Top View)

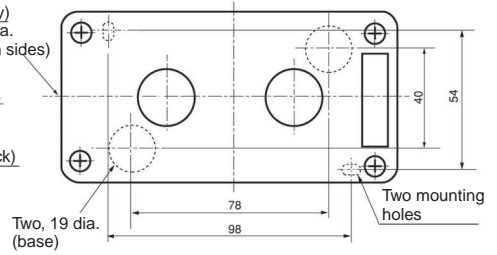

A22Z-B203 (Three Holes)

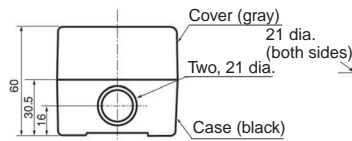
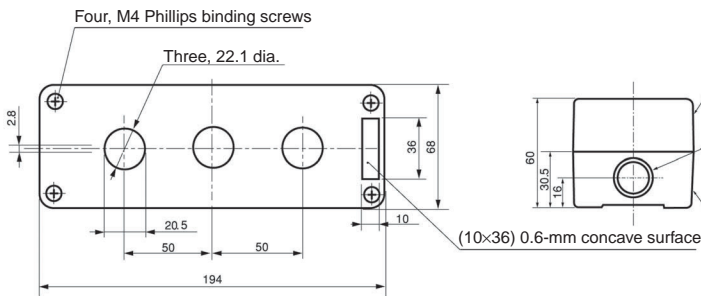

Cable Port Hole (Top View)

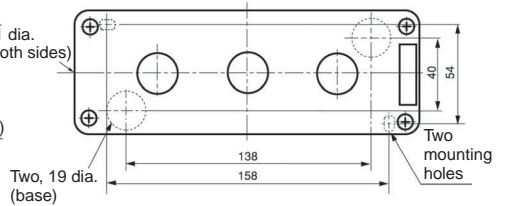

Panel Mounting Hole

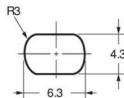

Terminal Arrangement (Bottom View)

Non-lighted (SPST-NO + SPST-NC)	Lighted (SPST-NO + SPST-NC)	Non-lighted (DPST-NO + DPST-NC)

Terminal Connection

Type	Terminal connection
Non-lighted (SPST-NO + SPST-NC)	<p>Bottom view</p>
Non-lighted (DPST-NO + DPST-NC)	<p>Bottom view</p>
Lighted without Voltage Reduction Unit (SPST-NO + SPST-NC)	<p>Bottom view</p>
Lighted with Voltage Reduction Unit (SPST-NO + SPST-NC)	<p>Bottom view</p>

Panel Cutouts

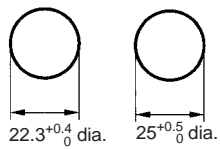

- Note:**
1. When applying coating such as paint to the panel, the dimensions should be those after the application of coating. Lock ring is provided as a standard item.
 2. Recommended panel thickness: 1 to 5 mm.
 3. Use an A22Z-R25 Ring when mounting to a panel with 25-mm holes.

Installation

Common to A22, A22S/W, A22K, M22, and A22E

■ Mounting to the Panel

Panel Hole Dimensions

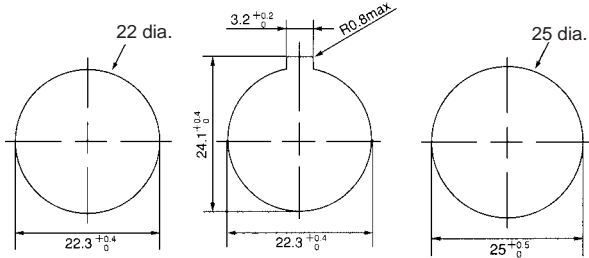

For 25-dia. holes, always use 25-dia. Rings. (Since the cutout dimensions are large, IP65 cannot be guaranteed unless 25-dia. Rings are used.)

If outer surface treatment such as coating is performed for the panel, the panel dimensions after outer surface treatment must meet the specified panel dimensions.

Note: Recommended panel thickness: 1 to 5 mm.

Matrix Installation

1. The following panel hole dimensions apply when Switch Unit and the Standard-size Legend Plate Frame and Lock Ring are mounted, and lead wires are connected directly to the Switch Block.

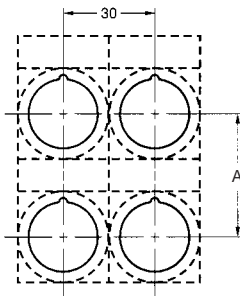

2. The following panel hole dimensions apply when the Large-size Legend Plate Frame is mounted, and when crimp terminals are connected to the Switch Block terminals.

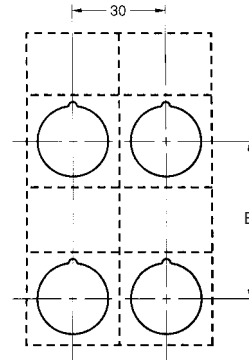

Pitches A and B between the centers of the mounting holes are as follows:

For 1. above:

Switch Blocks	A
A22-10, A22-10S, A22-01, A22-01S	45 mm min.
A22-20, A22-20S, A22-02, A22-02S, A22-11, A22-11S	55 mm min.

For 2. above:

Type of crimp terminal	Switch Blocks	B
Bare crimp terminals	A22-10, A22-10S, A22-01, A22-01S	51 mm min.
	A22-20, A22-20S, A22-02, A22-02S, A22-11, A22-11S	61 mm min.
Crimp terminals with insulating sheath	A22-10, A22-10S, A22-01, A22-01S	60 mm min.
	A22-20, A22-20S, A22-02, A22-02S, A22-11, A22-11S	70 mm min.

Note: 1. The above dimensions are the minimum dimensions for when the wires described under *Applicable Wire Size* on page 165 are used. If a different wires are used, the wiring dimensions may be different so determine an appropriate pitch before setup.

2. With pushbuttons of external dimensions greater than 30 mm, set the pitch according to the dimensions. (When using matrix installation for the A22-M□, mount with a pitch of 40 mm instead of 30 mm in the diagram above.)

3. When using a pushbutton with external dimensions exceeding 30 mm, use a pitch appropriate for the pushbutton.

Mounting the Operation Unit on the Panel

Insert the Operation Unit (Pushbutton, etc.) from the front surface of the panel, insert the Lock Ring and the mounting nut from the terminal side, then tighten the nut. Before tightening, check that the rubber washer is present between the Pushbutton Unit and the panel.

When using a Legend Plate Frame, put one rubber washer each between the Legend Plate Frame and the panel and between the Operation Unit and the Legend Plate Frame. (One rubber washer will be provided when one Legend Plate Frame is ordered.)

Align the Lock Ring with the groove in the casing, then insert the Lock Ring so that its edge is located on the panel side.

Tighten the mounting nut at a torque of 0.98 to 1.96 N·m.

When using a Lock Ring, replace with the supplied Lock Ring, insert the projecting part into the lock slot, and then tighten the mounting nut.

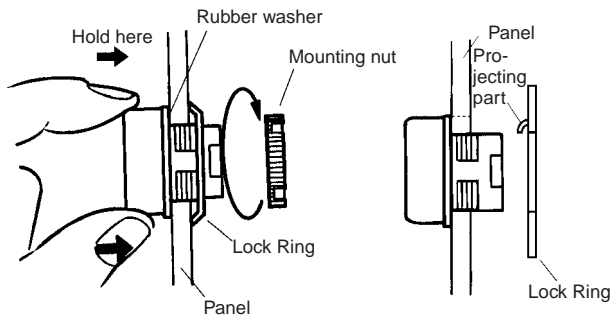

When the panel cutout dimension is 25 dia., remove the supplied rubber washer and mount the 25-dia. Ring as shown below. (Since the A22Z-R25 is not attached to the main body, order separately.)

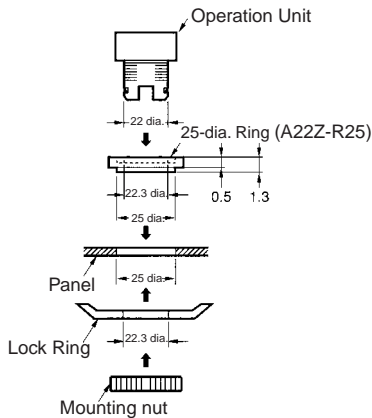

Mounting the Switch on the Pushbutton Unit

Insert the Pushbutton Unit into the Switch Unit, aligning the arrow mark inscribed on the Case with the lever on the Switch Blocks, then move the lever in the direction indicated by the arrow in the following figure.

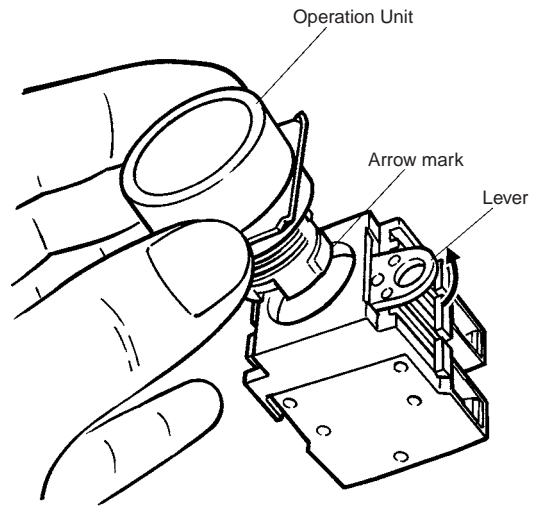

Removing the Switch

Move the lever in the direction indicated by the arrow in the following figure, then pull the Pushbutton Unit or the Switch Blocks.

Since the lever has a hole with an inside diameter of 6.5 mm, the lever can be moved in the specified direction by inserting a screwdriver into the hole and then moving the screwdriver.

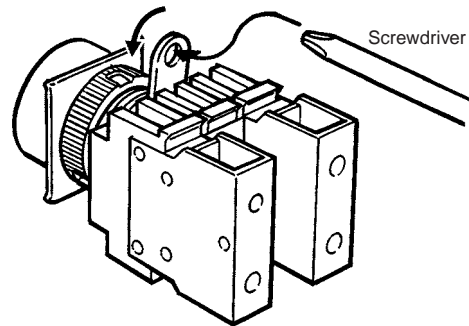

Mounting/Replacing the Color Cap

Projection, Fall-guard

Grip and rotate the Color Cap with your fingers.

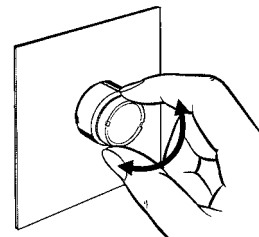

Half-guard Indicators

Put the tips of the Cap Tightening Tool (A22Z-3908) into the Color Cap slot and turn the Tool.

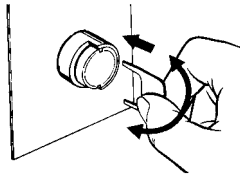

Assembling the Cap

Lighted Pushbutton Switch

Mount the Color Cap so that the protrusions inside the cap fit into the grooves in the Pushbutton Unit.

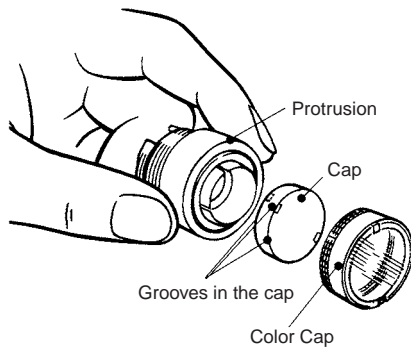

Indicator

Mount the Color Cap so that the protrusions inside the Pushbutton Unit fit into the grooves in the cap.

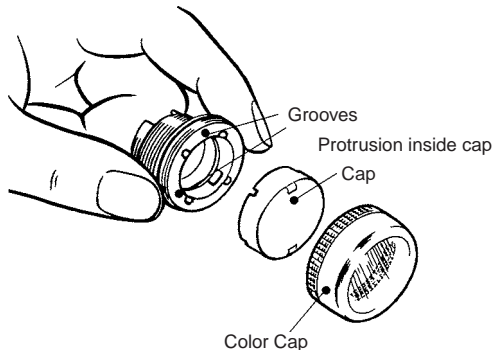

Square Pushbutton/Indicator

Removing the Color Cap:
Insert the protruding tip of the Cap Puller (A3PJ-5080) into the Cap slot, hold the plate spring, and pull them to remove the Color Cap.

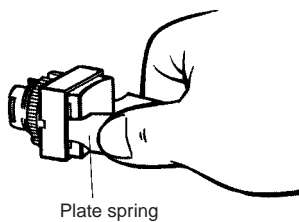

Mounting the Color Cap:

Mount the Color Cap on the flange and firmly push the Color Cap. When the Color Cap is inserted, check whether it operates properly. When replacing the Lamp, remove the Color Cap and diffusion plate with fingers or Cap Puller.

Attach the Character Film properly so that it fits inside the protruding part of the diffusion plate. Then, match the diffusion plate to the square flange and insert the Cap.

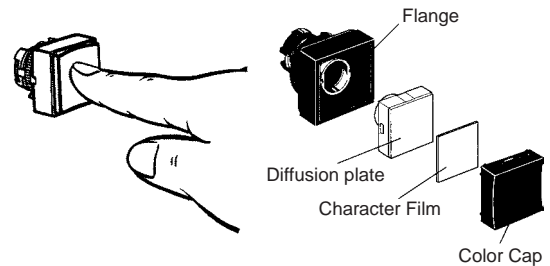

Emergency Stop Switch

Insert the protrusion of the Tightening Wrench (A22Z-3905) into the Cap slot and then turn to remove the Cap.

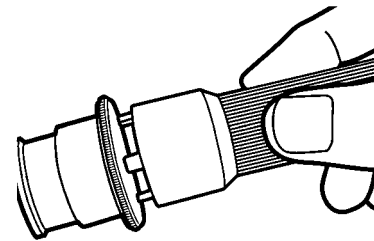

Installing/Replacing the Lamp

Installing/Replacing from the Panel Surface

Insert the Lamp Extractor (A22Z-3901) into the lamp, then rotate the Extractor while pressing it.

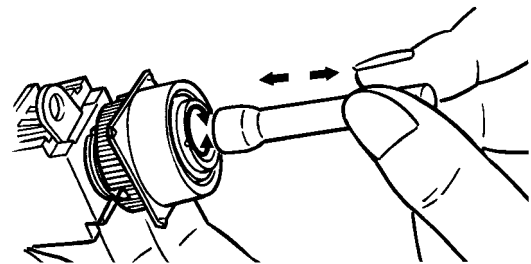

Installing/Replacing on the Switch

Grip the lamp with your fingers, then rotate the lamp while pressing it against the Switch.

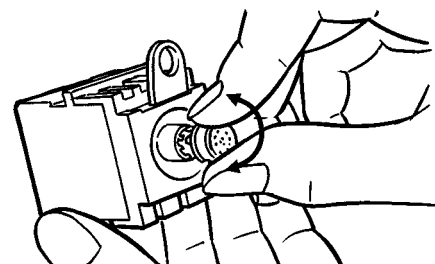

■ Control Box (Enclosure)

Mounting the Switch

The Standard-size Legend Plate Frame can be mounted. Mount the Frame as shown in the following diagram. Mount the Switch in the same way as for an ordinary panel.

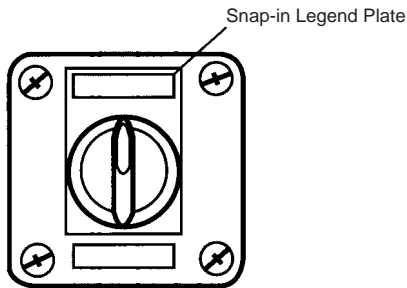

Creating a Cable Port Hole

Place the tip of a screwdriver on the surface where the cable port hole is to be created with the cover attached and strike the screwdriver to punch a hole. Attempts to punch a hole on the other side of the case will damage the Box.

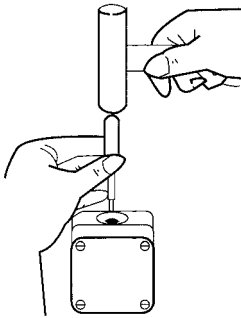

Securing the Connector Cable

1. Insert the connector into the cable port hole in the Box and secure with the fixing nut inside the box.
2. Open a hole in the thin rubber section of the rubber ring.
3. Pass the tightening cap through the cable, insert the cable into the connector, and tighten the hexagonal nut to secure the cable.

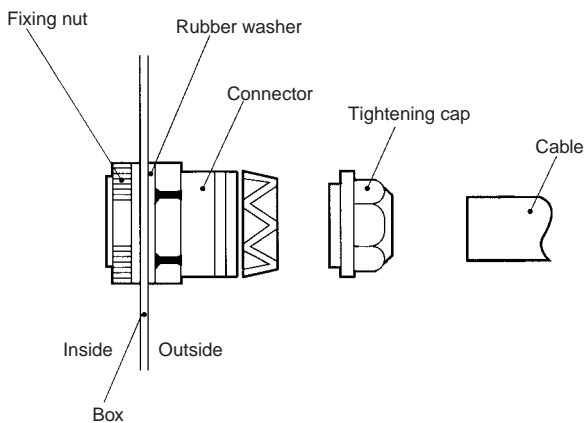

Cable diameter	Connector
7 to 9 dia.	A22Z-3500-1
9 to 11 dia.	A22Z-3500-2

■ Installing/Removing the Switch Blocks

Installing the Switch Blocks

Hook the small protrusion on the Switch Block into the groove on the Mounting Latch on the other side of the lever, then push up the Switch Block in the direction indicated by the arrow in the figure below.

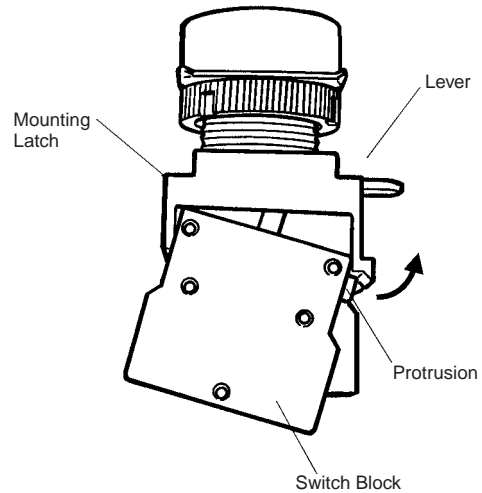

Removing the Switch Blocks

Insert a screwdriver between the Mounting Latch and the Switch Block, then push down the screwdriver in the direction indicated by the arrow in the following figure.

Use either of the following screwdrivers.

Flat-head screwdriver 3 to 6 mm

Phillips screwdriver 3 to 6 mm

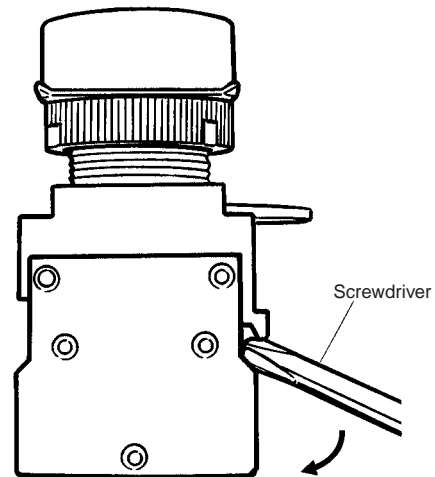

■ Wiring

Wiring Round Crimp Terminals

Loosen the terminal screw from the Switch Unit until it completely comes off the groove, insert a screwdriver as shown in the following figure, then push up the washer in the direction indicated by the arrow to temporarily secure it. Now, a round crimp terminal can be connected. After inserting the terminal, tighten the screws to complete wiring.

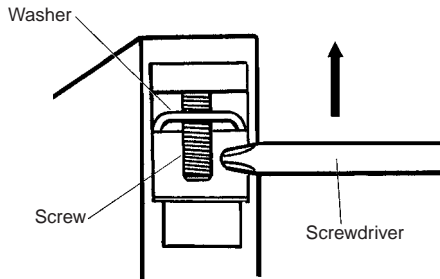

■ Engraving

Engrave the characters on the surface on the Cap. Make sure that the characters are aligned parallel to the imaginary line connecting the two protruding portions to the left and right of the Cap.

The characters must not be engraved deeper than 0.5 mm. Apply an alcohol-based paint coating, such as melamine, alkyd, or acrylic resin paint coating, to the engraved characters.

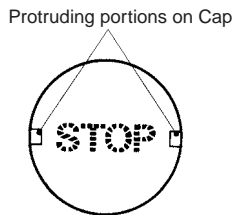

■ Affixing Character Film

Hold the Cap, remove the cardboard on the Film, and attach the Film to the Cap. Make sure that the protruding portions of the Cap engage the cutout portions of the Film and that the characters are aligned parallel to the imaginary line connecting the two protruding portions to the left and right of the Cap.

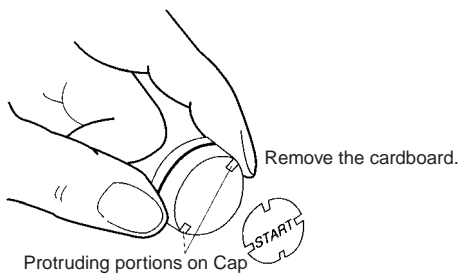

■ Mounting and Dismounting Snap-in Legend

Press and secure the Snap-in Legend Plate onto the Legend Plate Frame.

The direction of the characters will vary with the mounting direction of the control panel if the Switch is a knob or key selector model.

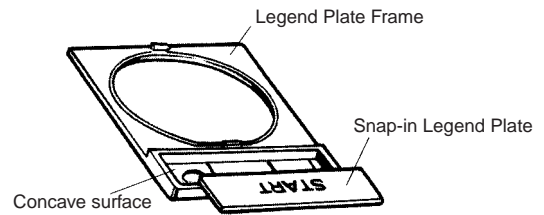

To easily remove the Snap-in Legend Plate from the Legend Plate Frame mounted to the panel, insert a Tool with a thin tip into the space between the Snap-in Legend Plate and the Legend Plate Frame.

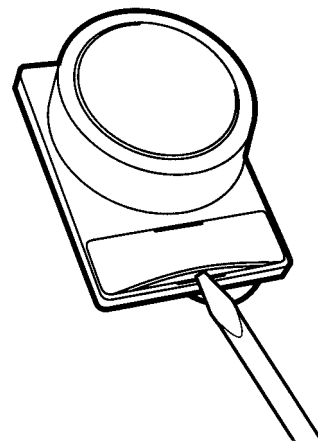

The Snap-in Legend Plate is easily removed by pressing the Snap-in Legend Plate from the back of the Legend Plate Frame.

The Legend Plate Frame is made of acrylic resin, which is easily damaged by shock. Be sure to handle the Legend Plate Frame with care.

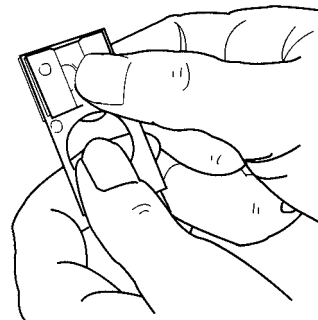

■ Engraving Method

Material: Acrylic

Engrave the characters directly on the matted side of the Snap-in Legend Plate.

The characters must be engraved no deeper than 0.5 mm.

Apply alcohol-based paint coating to the engraved characters.

If the Snap-in Legend Plate is transparent, engrave the mirror-written characters on the back of the Snap-in Legend Plate and apply paint coating to the characters. Then apply paint coating of a different color to the remaining part of the Snap-in Legend Plate.

■ Mounting Three-throw Spacer (A22Z-3003)

Press and secure the two protruding portions of the Three-throw Spacer to the two indented portions of the inner side of the control panel.

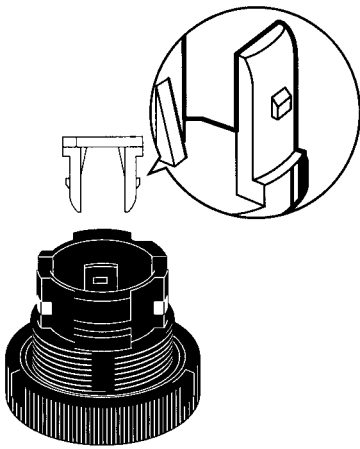

Precautions

Common to A22, A22S/W, A22K, M22, and A22E

⚠ WARNING

Do not apply a voltage between the incandescent lamp and the terminal that is greater than the rated voltage. If the incandescent lamp is broken, the Operation Units may pop out.
Always turn OFF the power and wait for 10 minutes before replacing the incandescent lamp. If the lamp is replaced immediately after the power is turned OFF, the remaining heat may cause burns.

Correct Use

Mounting

Always make sure that the power is turned OFF before mounting, removing, or wiring the Switch, or performing maintenance.
Do not tighten the mounting ring more than necessary using tools such as pointed-nose pliers. Doing so will damage the mounting ring. The tightening torque is 0.98 to 1.96 N·m.
Recommended panel thickness: 1 to 5 mm.

Wiring

After wiring the Switch, maintain an appropriate clearance and creepage distance.
When DC-specific LEDs are used, wire the Switch so that the X1 terminal is positive.
Terminal screws must be Phillips or slotted M3.5 screws with a square washer.
The tightening torque is 1.08 to 1.27 N·m.
Single wires, stranded wires, and crimp terminals can be connected to the Switch.

Applicable Wire Size

Stranded wire: 2 mm² max.
Solid wire: 1.6 dia. max.

Bare Crimp Terminals

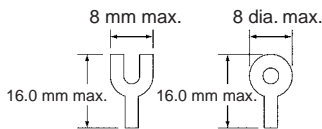

Crimp Terminals with Insulating Sheath

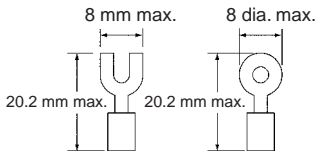

ALL DIMENSIONS SHOWN ARE IN MILLIMETERS.
To convert millimeters into inches, multiply by 0.03937. To convert grams into ounces, multiply by 0.03527.

Operating Environment

The IP65 model is designed with a degree of protection so that it will not sustain damage if it is subjected to water from any direction to the front of the panel.

Using the Microload

Insert a contact protection circuit, if necessary, to prevent the reduction of life expectancy due to extreme wear on the contacts caused by loads where inrush current occurs when the contact is opened and closed.

The minimum applicable load is the N-level reference value. This value indicates the malfunction reference level for the reliability level of 60% (λ 60) (conforming to JIS C5003).

The equation, λ 60 = 0.5×10^{-6} /operations indicates that the estimated malfunction rate is less than 1/2,000,000 operations with a reliability level of 60%.

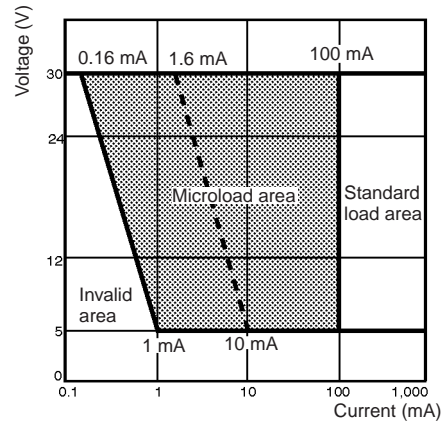

LED

The LED current-limiting resistor is built-in, so internal resistance is not required.
If commercially available LEDs are used, select the ones that meet the following conditions:
Base: BA9S/13□
Overall length: 26 mm max.
Power consumption: 2.6 W max.

Others

If the panel is to be finished with coating, etc., make sure that the panel meets the specified dimensions after the coating.
Do not subject the Switch to extreme shock or vibration. Doing so will cause malfunctions and damage to the Switch.

Knob-type Selector Switch A22S/W

Install in 22-dia. or 25-dia. Panel Cutout

- Easy mounting and removal of Switch Unit.
- Increase wiring efficiency with three-row mounting of Switch Blocks.
- Finger protection mechanism on Switch Unit provided as a standard feature.
- Use 25-dia. ring to install in 25-dia. panel cutouts.
- Mounted using either open-type (fork-type) or closed-type (round-type) crimp terminals.
- IP65 oil resistance (non-lighted models)
IP65 (lighted models)
- EN60947-5-1
- UL and cUL approved (File No. E41515).

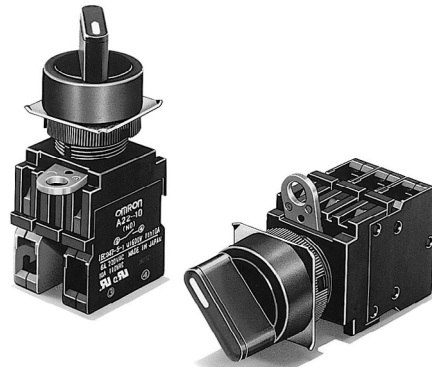

Model Number Structure

Model Number Legend

Completely Assembled

Shipped as a set which includes the Selector, Lamp (lighted models only), and Switch.

A22-1-2-3-4-5

1 Lighted/Non-lighted

Code	Description
S	Non-lighted
W	Lighted

2 Number of Notches/Reset Method

Code	Description
2M	2 notches/Manual
2A	2 notches/Automatic
3M	3 notches/Manual
3A	3 notches/Automatic

3 Illumination Color

Code	Description
None	Black (for non-lighted models only)
R	Red
G	Green
Y	Yellow
A	Blue

4 Light Source

Without Voltage Reduction Unit		
Code	Operating Voltage	
None	Non-lighted	
6D	LED	6 VDC
6A		6 VAC
12A		12 VAC/VDC
24A		24 VAC/VDC
5	Incandescent lamp	5 VAC/VDC
12		12 VAC/VDC
24		24 VAC/VDC

5 Contacts

Code	Description
10	SPST-NO (See note 1.)
01	SPST-NC (See note 1.)
11	SPST-NO + SPST-NC
20	DPST-NO
02	DPST-NC

Note: 1. For models with 2 notches

2. The contacts are rated for standard loads. For microloads, refer to Accessories section for the A22.

With Voltage Reduction Unit		
None	Non-lighted	
T1	LED	100 VAC (See note 2.)
T2		200 VAC (See note 3.)

Note: 1. The LED lamp (24 VAC/VDC) can be lit by directly applying 100 VAC/VDC (200 VAC/VDC) to the lamp terminal. LED incorporates the 24-VAC/VDC models.

2. Operational voltage: 95 to 115 VAC
3. Operational voltage: 190 to 230 VAC

Subassembled

The Selector, Lamp, or Switch can be ordered separately. Use them in combination for models that are not available as assembled Units. These can also be used as inventory for maintenance parts.

1. Selector

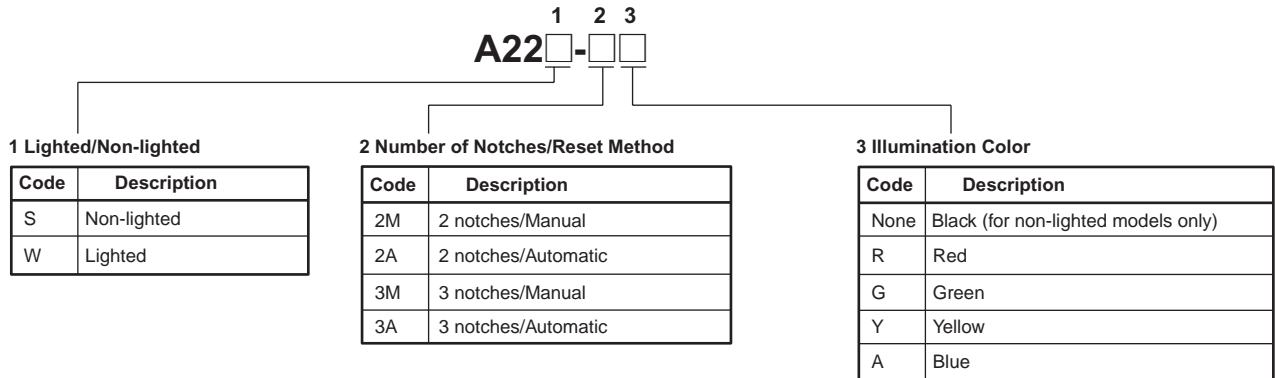

2. Lamp

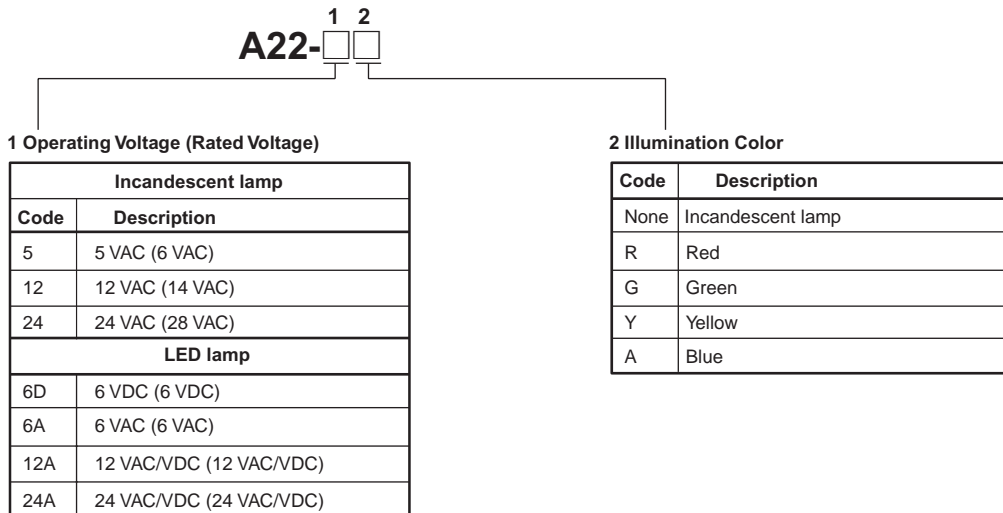

3. Switch (General-purpose Load)

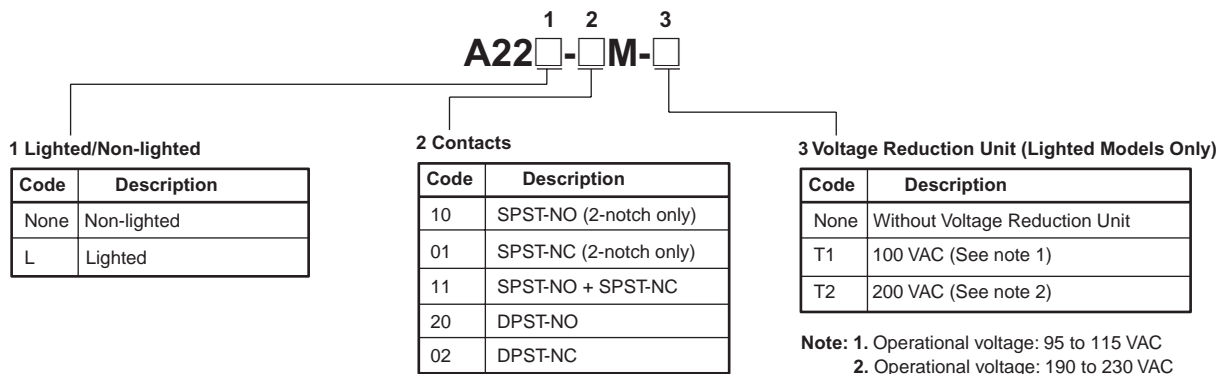





Ordering Information



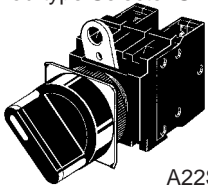



■ List of Models

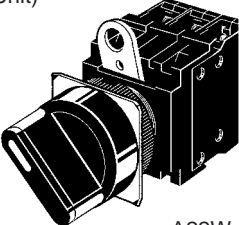

Ordering as a Set

Non-lighted



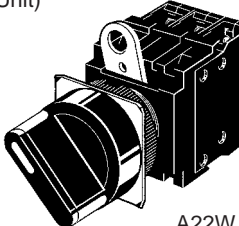

Appearance	Number of notches	Resetting method	Output	Model	Color of Selector
Knob-type Selector Switch  A22S	2 notches	Manual 	SPST-NO	A22S-2M-10	Black
			SPST-NC	A22S-2M-01	
			SPST-NO + SPST-NC	A22S-2M-11	
			DPST-NO	A22S-2M-20	
			DPST-NC	A22S-2M-02	
		Automatic 	SPST-NO	A22S-2A-10	
			SPST-NC	A22S-2A-01	
			SPST-NO + SPST-NC	A22S-2A-11	
			DPST-NO	A22S-2A-20	
			DPST-NC	A22S-2A-02	
	3 notches	Manual 	SPST-NO + SPST-NC	A22S-3M-11	
			DPST-NO	A22S-3M-20	
			DPST-NC	A22S-3M-02	
		Automatic 	SPST-NO + SPST-NC	A22S-3A-11	
			DPST-NO	A22S-3A-20	
DPST-NC			A22S-3A-02		

Lighted (Without Voltage Reduction Unit)

Appearance	Number of notches	Resetting method	Output	Operating voltage	Model	Illumination color
Knob-type Selector Switch LED lighting (without Voltage Reduction Unit)  <p>A22W</p>	2 notches	Manual 	SPST-NO	6 VDC	A22W-2M□-6D-10	Insert one of the following letters into the box □. R (red) Y (yellow) G (green) A (blue)
				6 VAC	A22W-2M□-6A-10	
				12 VAC/VDC	A22W-2M□-12A-10	
				24 VAC/VDC	A22W-2M□-24A-10	
			SPST-NC	6 VDC	A22W-2M□-6D-01	
				6 VAC	A22W-2M□-6A-01	
				12 VAC/VDC	A22W-2M□-12A-01	
				24 VAC/VDC	A22W-2M□-24A-01	
			SPST-NO + SPST-NC	6 VDC	A22W-2M□-6D-11	
				6 VAC	A22W-2M□-6A-11	
				12 VAC/VDC	A22W-2M□-12A-11	
				24 VAC/VDC	A22W-2M□-24A-11	
			DPST-NO	6 VDC	A22W-2M□-6D-20	
				6 VAC	A22W-2M□-6A-20	
				12 VAC/VDC	A22W-2M□-12A-20	
				24 VAC/VDC	A22W-2M□-24A-20	
			DPST-NC	6 VDC	A22W-2M□-6D-02	
				6 VAC	A22W-2M□-6A-02	
	12 VAC/VDC	A22W-2M□-12A-02				
	24 VAC/VDC	A22W-2M□-24A-02				
	Automatic 	2 notches	Automatic 	SPST-NO	6 VDC	A22W-2A□-6D-10
					6 VAC	A22W-2A□-6A-10
					12 VAC/VDC	A22W-2A□-12A-10
					24 VAC/VDC	A22W-2A□-24A-10
				SPST-NC	6 VDC	A22W-2A□-6D-01
					6 VAC	A22W-2A□-6A-01
					12 VAC/VDC	A22W-2A□-12A-01
					24 VAC/VDC	A22W-2A□-24A-01
				SPST-NO + SPST-NC	6 VDC	A22W-2A□-6D-11
					6 VAC	A22W-2A□-6A-11
12 VAC/VDC					A22W-2A□-12A-11	
24 VAC/VDC					A22W-2A□-24A-11	
DPST-NO				6 VDC	A22W-2A□-6D-20	
				6 VAC	A22W-2A□-6A-20	
				12 VAC/VDC	A22W-2A□-12A-20	
				24 VAC/VDC	A22W-2A□-24A-20	
DPST-NC				6 VDC	A22W-2A□-6D-02	
				6 VAC	A22W-2A□-6A-02	
	12 VAC/VDC	A22W-2A□-12A-02				
	24 VAC/VDC	A22W-2A□-24A-02				
3 notches	Manual 	Manual 	SPST-NO + SPST-NC	6 VDC	A22W-3M□-6D-11	
				6 VAC	A22W-3M□-6A-11	
				12 VAC/VDC	A22W-3M□-12A-11	
				24 VAC/VDC	A22W-3M□-24A-11	
			DPST-NO	6 VDC	A22W-3M□-6D-20	
				6 VAC	A22W-3M□-6A-20	
				12 VAC/VDC	A22W-3M□-12A-20	
				24 VAC/VDC	A22W-3M□-24A-20	
			DPST-NC	6 VDC	A22W-3M□-6D-02	
				6 VAC	A22W-3M□-6A-02	
				12 VAC/VDC	A22W-3M□-12A-02	
				24 VAC/VDC	A22W-3M□-24A-02	

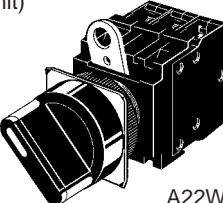
Appearance	Number of notches	Resetting method	Output	Operating voltage	Model	Illumination color
Knob-type Selector Switch LED lighting (without Voltage Reduction Unit)  A22W	3 notches	Automatic 	SPST-NO + SPST-NC	6 VDC	A22W-3A□-6D-11	Insert one of the following letters into the box □. R (red) Y (yellow) G (green) A (blue)
				6 VAC	A22W-3A□-6A-11	
				12 VAC/VDC	A22W-3A□-12A-11	
				24 VAC/VDC	A22W-3A□-24A-11	
			DPST-NO	6 VDC	A22W-3A□-6D-20	
				6 VAC	A22W-3A□-6A-20	
				12 VAC/VDC	A22W-3A□-12A-20	
				24 VAC/VDC	A22W-3A□-24A-20	
			DPST-NC	6 VDC	A22W-3A□-6D-02	
				6 VAC	A22W-3A□-6A-02	
				12 VAC/VDC	A22W-3A□-12A-02	
				24 VAC/VDC	A22W-3A□-24A-02	

Lighted (With Voltage Reduction Unit)

Appearance	Number of notches	Resetting method	Output	Operating voltage	Model	Selector symbol (color)		
Knob-type Selector Switch LED voltage-reduction lighting (with Voltage Reduction Unit)  A22W	2 notches	Manual 	SPST-NO	100 VAC	A22W-2M□-T1-10	Insert one of the following letters into the box □. R (red) Y (yellow) G (green) A (blue)		
				200 VAC	A22W-2M□-T2-10			
			SPST-NC	100 VAC	A22W-2M□-T1-01			
				200 VAC	A22W-2M□-T2-01			
			SPST-NO + SPST-NC	100 VAC	A22W-2M□-T1-11			
				200 VAC	A22W-2M□-T2-11			
			DPST-NO	100 VAC	A22W-2M□-T1-20			
				200 VAC	A22W-2M□-T2-20			
			DPST-NC	100 VAC	A22W-2M□-T1-02			
				200 VAC	A22W-2M□-T2-02			
			3 notches	Automatic 	SPST-NO		100 VAC	A22W-2A□-T1-10
							200 VAC	A22W-2A□-T2-10
	SPST-NC	100 VAC			A22W-2A□-T1-01			
		200 VAC			A22W-2A□-T2-01			
	SPST-NO + SPST-NC	100 VAC			A22W-2A□-T1-11			
		200 VAC			A22W-2A□-T2-11			
	DPST-NO	100 VAC			A22W-2A□-T1-20			
		200 VAC			A22W-2A□-T2-20			
	DPST-NC	100 VAC			A22W-2A□-T1-02			
		200 VAC			A22W-2A□-T2-02			
	Manual				SPST-NO + SPST-NC	100 VAC	A22W-3M□-T1-11	
						200 VAC	A22W-3M□-T2-11	
			DPST-NO	100 VAC	A22W-3M□-T1-20			
				200 VAC	A22W-3M□-T2-20			
DPST-NC			100 VAC	A22W-3M□-T1-02				
			200 VAC	A22W-3M□-T2-02				
Automatic		SPST-NO + SPST-NC	100 VAC	A22W-3A□-T1-11				
			200 VAC	A22W-3A□-T2-11				
		DPST-NO	100 VAC	A22W-3A□-T1-20				
			200 VAC	A22W-3A□-T2-20				
		DPST-NC	100 VAC	A22W-3A□-T1-02				
			200 VAC	A22W-3A□-T2-02				



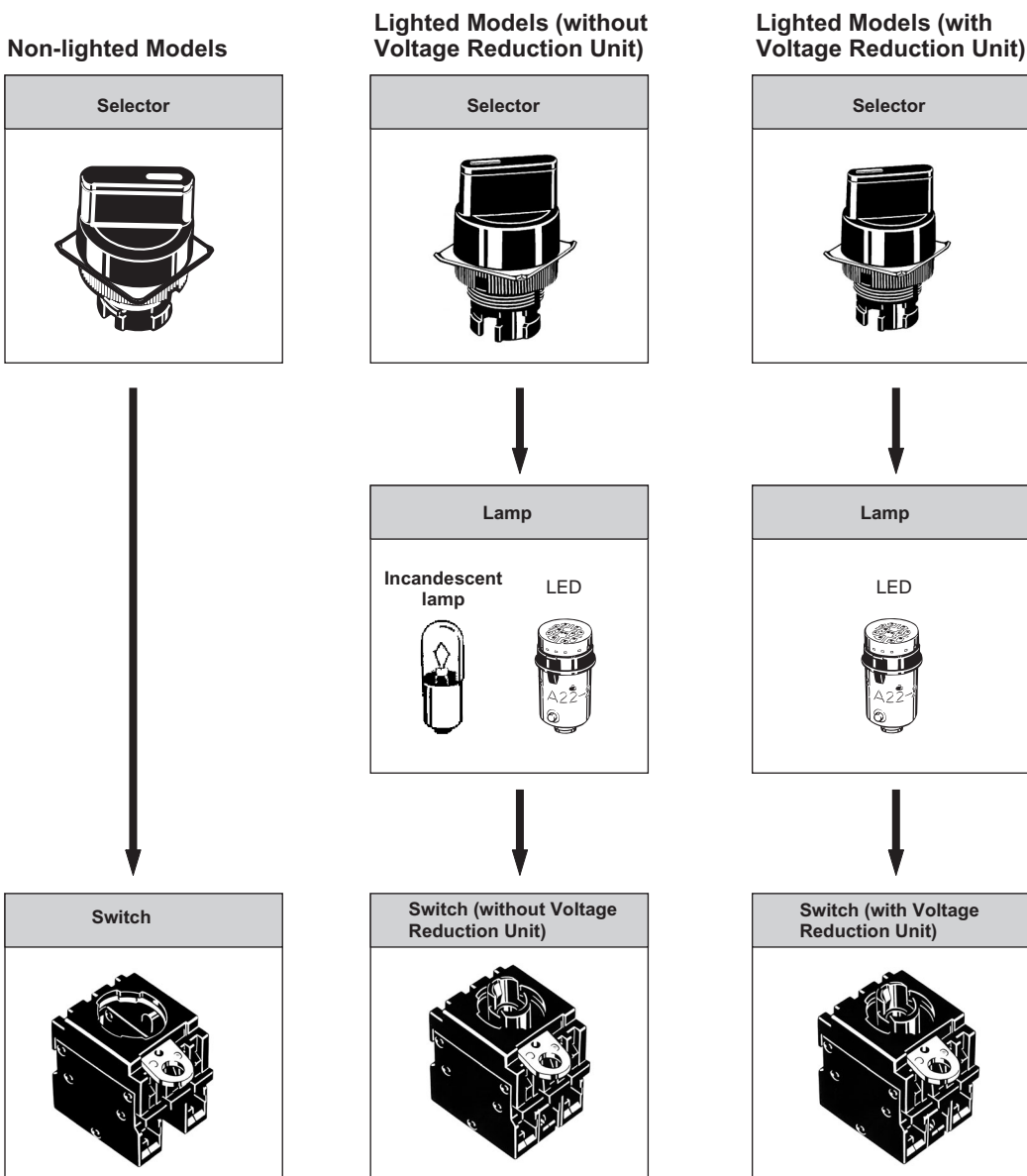

Note: When ordering, specify the symbol that indicates color of the Selector in the □ of the model number.





Ordering Individually







Selectors

Non-lighted (Color: Only Black is Available)

Notches	Reset method	Standard lever IP65 (oil-resistant)
2 notches	Manual 	A22S-2M
	Automatic 	A22S-2A
3 notches	Manual 	A22S-3M
	Automatic 	A22S-3A

Notches	Reset method	Standard lever IP65 (oil-resistant)
2 notches	Manual 	A22S-C2M
	Automatic 	A22S-C2A
3 notches	Manual 	A22S-C3M
	Automatic 	A22S-C3A

Lighted

Notches	Reset method	Selector color	Standard lever IP65
2 notches	Manual 	Red	A22W-2MR
		Green	A22W-2MG
		Yellow	A22W-2MY
		Blue	A22W-2MA
	Automatic 	Red	A22W-2AR
		Green	A22W-2AG
		Yellow	A22W-2AY
		Blue	A22W-2AA
3 notches	Manual 	Red	A22W-3MR
		Green	A22W-3MG
		Yellow	A22W-3MY
		Blue	A22W-3MA
	Automatic 	Red	A22W-3AR
		Green	A22W-3AG
		Yellow	A22W-3AY
		Blue	A22W-3AA

Note: Either incandescent lamps or LED lamps can be used with the above models.

Lamps

LED Lamp

Appearance	Operating voltage		6 V	12 V	24 V	24 V Super-bright
	AC/DC	LED light	Model			
	DC	Red	A22-6DR	---	---	---
		Green	A22-6DG	---	---	---
		Yellow (See note 2.)	A22-6DY	---	---	---
		Blue	A22-6DA	---	---	---
	AC	Red	A22-6AR	---	---	---
		Green	A22-6AG	---	---	---
		Yellow (See note 2.)	A22-6AY	---	---	---
		Blue	A22-6AA	---	---	---
	AC and DC	Red	---	A22-12AR	A22-24AR	A22-24ASR
		Green	---	A22-12AG	A22-24AG	A22-24ASG
		Yellow (See note 2.)	---	A22-12AY	A22-24AY	A22-24ASY
		Blue	---	A22-12AA	A22-24AA	A22-24ASA

Note: 1. For voltage-reduction lighting, use the A22-24A□.
 2. Used when the Selector color is yellow or white.

Incandescent Lamp

Operating voltage	5 VAC/VDC	12 VAC/VDC	24 VAC/VDC
	A22-5	A22-12	A22-24

Switches (General-purpose Load)

Non-lighted

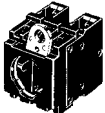
Switch operation 	Contacts	Model
Automatic	SPST-NO	A22-10M
	SPST-NC	A22-01M
	SPST-NO + SPST-NC	A22-11M
	DPST-NO	A22-20M
	DPST-NC	A22-02M

Lighted

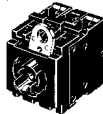
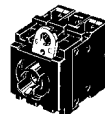
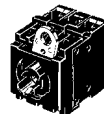
Switch operation	Contacts	Voltage-reduction circuit		
		Without Voltage Reduction Unit 	With Voltage Reduction Unit	
			110 VAC 	220 VAC 
Automatic	SPST-NO	A22L-10M	A22L-10M-T1	A22L-10M-T2
	SPST-NC	A22L-01M	A22L-01M-T1	A22L-01M-T2
	SPST-NO + SPST-NC	A22L-11M	A22L-11M-T1	A22L-11M-T2
	DPST-NO	A22L-20M	A22L-20M-T1	A22L-20M-T2
	DPST-NC	A22L-02M	A22L-02M-T1	A22L-02M-T2

Note: For voltage-reduction lighting, use the A22-24A□.

■ Accessories (Order Separately)

The A22S/W uses the same accessories as the A22. Refer to the relevant information in the section for the A22.

Specifications

With the exception of the following items, the specifications are the same as for the A22. Refer to the relevant information in the *Specifications* section for the A22.

■ Operation Angle

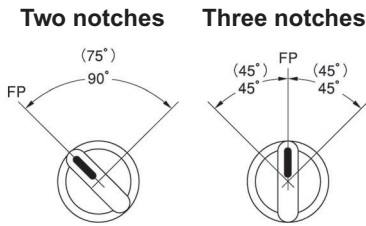

Note: 1. The angle used for automatic reset is shown in parentheses.
2. FP: Free Position

■ Contacts

2-notch Type

Knob position	SPST-NO	SPST-NC	SPST-NO + SPST-NC	DPST-NO	DPST-NC

3-notch Type

Knob position	SPST-NO + SPST-NC	DPST-NO	DPST-NC

Nomenclature

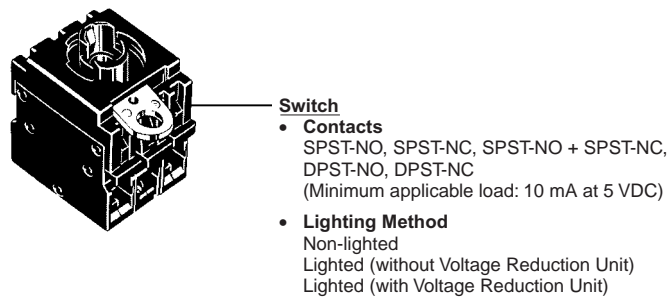
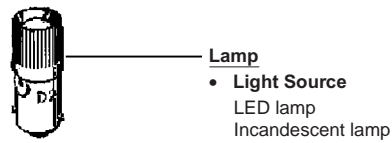
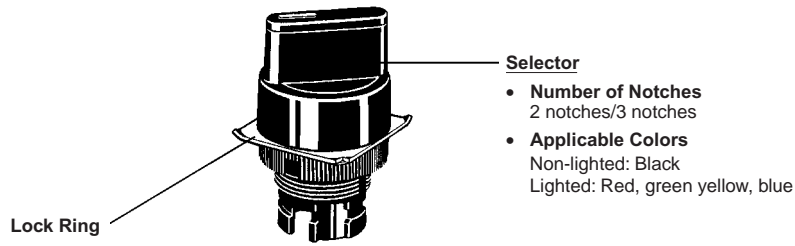

Dimensions

Note: All units are in millimeters unless otherwise indicated.

■ Knob-type Selector Switch (Lighted/Non-lighted)

A22S/A22W

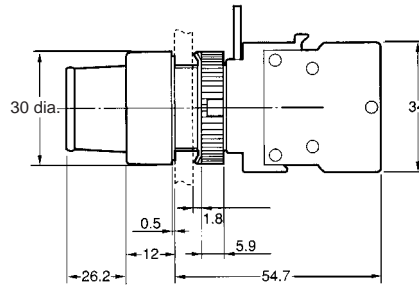
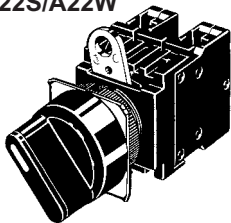

A22S-C

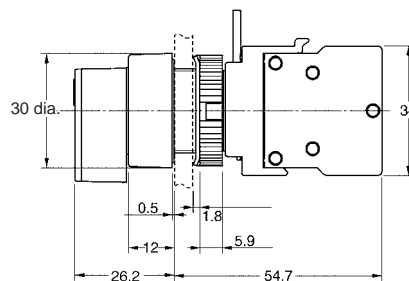
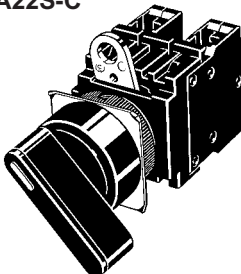

■ Accessories (Common to A22, A22S/W, A22K, M22, and A22E)

The A22S/W uses the same accessories as the A22. Refer to the relevant information in the corresponding section for the A22.

■ Terminal Arrangement (Bottom View)

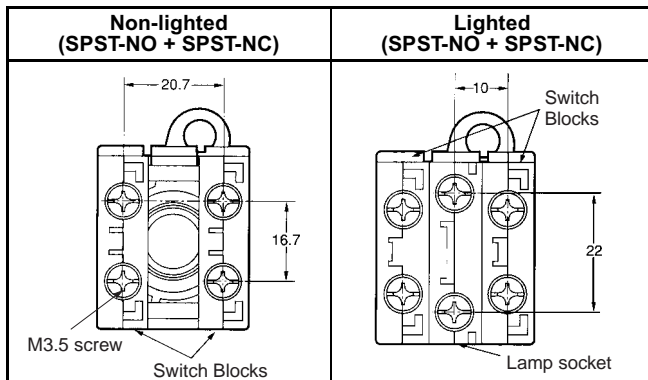

■ Terminal Connection

Type	Connection diagram
Non-lighted	<p>Bottom view</p>
Lighted without Voltage Reduction Unit	<p>Bottom view</p>
Lighted with Voltage Reduction Unit	<p>Bottom view</p>

Note: The above terminal connection diagrams are examples for SPST-NO + SPST-NC.

■ Panel Cutouts (Top View)

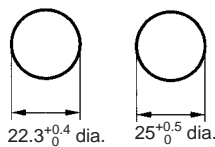

- Note:**
1. When applying coating such as paint to the panel, the dimensions should be those after the application of coating. Lock Ring is provided as a standard item.
 2. Recommended panel thickness: 1 to 5 mm.
 3. Use an A22Z-R25 Ring when mounting to a panel with 25-mm holes.

Installation

The A22S/W uses the same installation method as the A22. Refer to the relevant information in the *Installation* section for the A22.

Precautions

The precautions for the A22S/W are the same as those for the A22. Refer to the relevant information in the *Precautions* section for the A22 and the *Technical Information for Pushbutton Switches* (Cat. No. A143).

ALL DIMENSIONS SHOWN ARE IN MILLIMETERS.
To convert millimeters into inches, multiply by 0.03937. To convert grams into ounces, multiply by 0.03527.

3Key-type Selector Switch A22K

Install in 22-dia. or 25-dia. Panel Cutout

- Easy mounting and removal of Switch Unit.
- Increase wiring efficiency with three-row mounting of Switch Blocks.
- Finger protection mechanism on Switch Unit provided as a standard feature.
- Use 25-dia. ring to install in 25-dia. panel cutouts.
- Mounted using either open-type (fork-type) or closed-type (round-type) crimp terminals.
- IP65 oil resistance
- EN60947-5-1
- UL and cUL approved (File No. E41515).

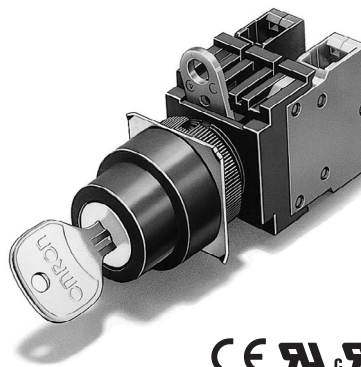

Model Number Structure

■ Model Number Legend

Completely Assembled

Shipped as a set which includes the Selector and Switch.

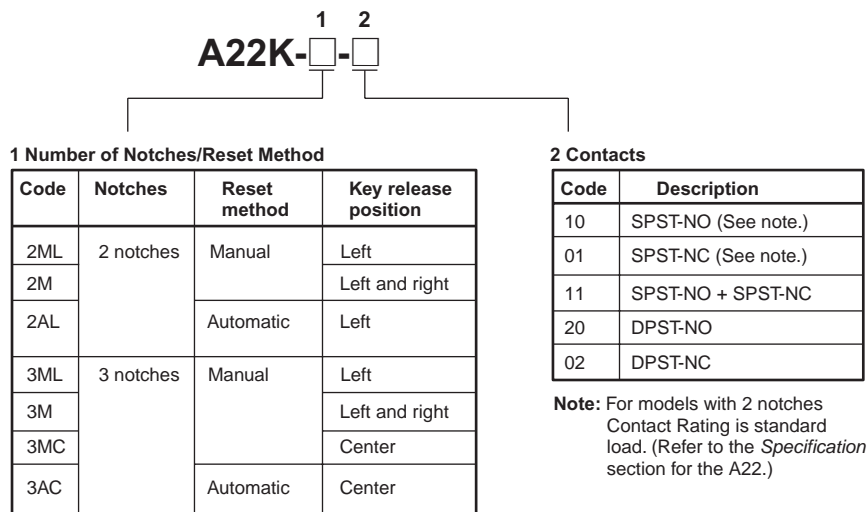

Subassembled

The Selector, Lamp, or Switch can be ordered separately. Use them in combination for models that are not available as assembled Units. These can also be used as inventory for maintenance parts.

1. Selector

A22K-¹
□

1 Number of Notches/Reset Method

Code	Notches	Reset method	Key release position
2ML	2 notches	Manual	Left
2M			Left and right
2AL		Automatic	Left
3ML	3 notches	Manual	Left
3M			Left and right
3MC			Center
3AC		Automatic	Center

2. Switch

Non-lighted

A22-¹
□M











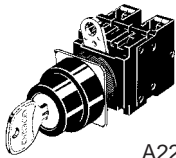

















1 Contacts

Code	Description
10	SPST-NO (2-notch models only)
01	SPST-NC (2-notch models only)
11	SPST-NO + SPST-NC
20	DPST-NO
02	DPST-NC

Ordering Information

■ List of Models

Ordering as a Set

Appearance	Number of notches	Reset method	Output	Key release position	Model	Color of Selector	
Key-type Selector Switch  A22K	2 notches	Manual 	SPST-NO		A22K-2ML-10	Black	
					A22K-2M-10		
			SPST-NC		A22K-2ML-01		
					A22K-2M-01		
			SPST-NO + SPST-NC		A22K-2ML-11		
					A22K-2M-11		
			DPST-NO		A22K-2ML-20		
					A22K-2M-20		
			DPST-NC		A22K-2ML-02		
					A22K-2M-02		
	Automatic 			SPST-NO		A22K-2AL-10	
						SPST-NC	A22K-2AL-01
						SPST-NO + SPST-NC	A22K-2AL-11
						DPST-NO	A22K-2AL-20
						DPST-NC	A22K-2AL-02
	3 notches	Manual 		SPST-NO + SPST-NC		A22K-3ML-11	
						A22K-3M-11	
						A22K-3MC-11	
				DPST-NO		A22K-3ML-20	
						A22K-3M-20	
					A22K-3MC-20		
DPST-NC					A22K-3ML-02		
					A22K-3M-02		
					A22K-3MC-02		
Automatic 						SPST-NO + SPST-NC	
	DPST-NO		A22K-3AC-20				
	DPST-NC		A22K-3AC-02				

Note: Two Keys are provided.

Ordering Individually

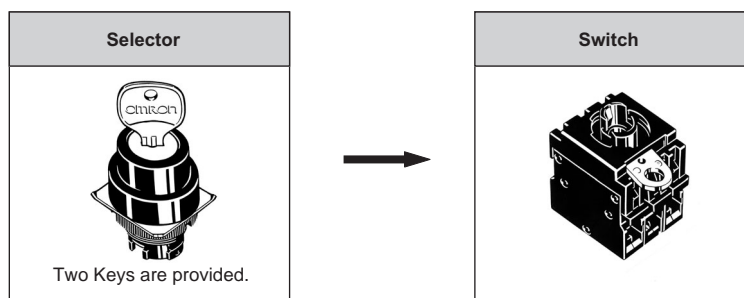

Selector

(Color: Only Black is available)

Appearance	Number of notches	Reset method	Key release position	Model
	2 notches	Manual		A22K-2ML
				A22K-2M
	3 notches	Automatic		A22K-2AL
				A22K-3ML
				A22K-3M
				A22K-3MC
	Automatic		A22K-3AC	

Note: Two keys are provided.

Switch

Appearance	Classification		Model	
	Lighted	Socket (without voltage-reduction circuit)	SPST-NO	A22-10M
			SPST-NC	A22-01M
			SPST-NO + SPST-NC	A22-11M
			DPST-NO	A22-20M
			DPST-NC	A22-02M

Note: DPST-NO + DPST-NC combination is also possible.

Accessories

Appearance	Model
	A22K-K

Note: Two keys are provided.

Accessories

The A22K uses the same accessories as the A22. Refer to the relevant information in the corresponding section for the A22.

Specifications

With the exception of the following items, the specifications are the same as for the A22. Refer to the relevant information in the *Specifications* section for the A22.

■ Operation Angle

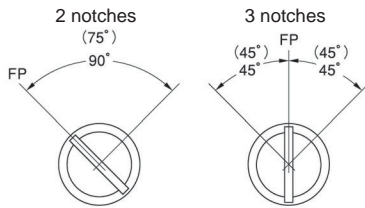

Note: 1. The angles in parentheses are for automatic-reset models.
 2. FP: Free position

■ Contacts

2-notch Type

Knob position	SPST-NO	SPST-NC	SPST-NO + SPST-NC	DPST-NO	DPST-NC

3-notch Type

Knob position	SPST-NO + SPST-NC	DPST-NO	DPST-NC

Nomenclature

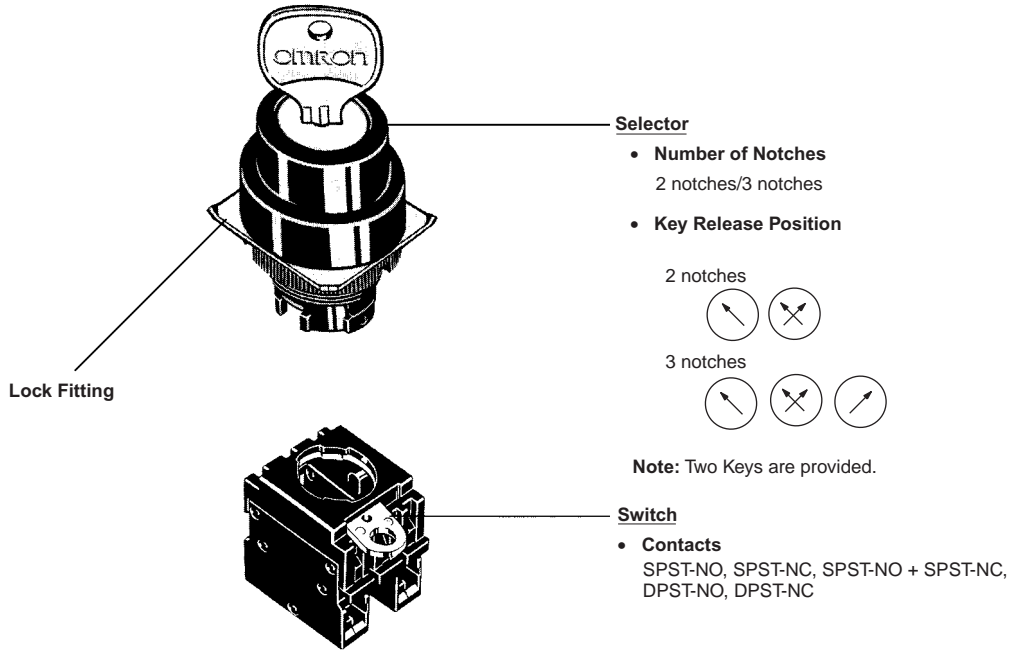

Dimensions

Note: All units are in millimeters unless otherwise indicated.

■ Key-type Selector Switch

A22K

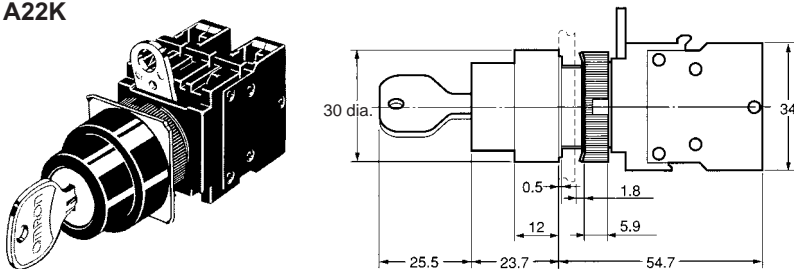

■ Accessories

The A22K uses the same accessories as the A22. Refer to the relevant information in the corresponding section for the A22.

■ Terminal Arrangement (Bottom View)

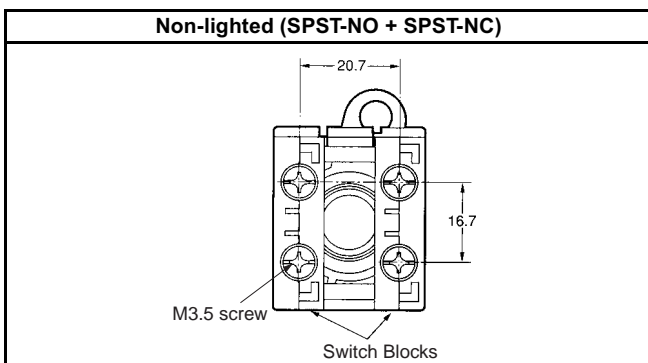

Terminal Connection

Type	Terminal connection
Non-lighted	<p style="text-align: center;">Bottom view</p>

Note: The above terminal connection diagrams are examples for SPST-NO + SPST-NC.

Panel Cutouts (Top View)

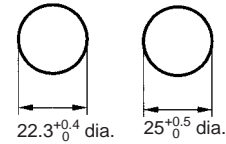

- Note:**
1. When applying coating such as paint to the panel, the dimensions should be those after the application of coating. Lock fitting is provided as a standard item.
 2. Recommended panel thickness: 1 to 5 mm.
 3. Use an A22Z-R25 Ring when mounting to a panel with 25-mm holes.

Installation

The A22K uses the same installation method as the A22. Refer to the relevant information in the *Installation* section for the A22.

Precautions

The precautions for the A22K are the same as those for the A22. Refer to the relevant information in the *Precautions* section for the A22 and the *Technical Information for Pushbutton Switches* (Cat. No. A143).

ALL DIMENSIONS SHOWN ARE IN MILLIMETERS.

To convert millimeters into inches, multiply by 0.03937. To convert grams into ounces, multiply by 0.03527.

Emergency Stop Switch A22E

Install in 22-dia. or 25-dia. Panel Cutout

- Direct opening mechanism to open the circuit when the contact welds →.
- Safety lock mechanism prevents operating errors.
- Easy mounting and removal of Switch Blocks using a lever.
- Mount three Switch Units in series to improve wiring efficiency.
- Finger protection mechanism on Switch Unit provided as a standard feature.
- Install using either round, or forked crimp terminals.
- Oil-resistant to IP65 (non-lighted models)/IP65 (lighted models)

Note: Refer to the *Common Precautions* for Pushbutton Switches on page 14, as well as the “*Safety Precautions*” on page 201.

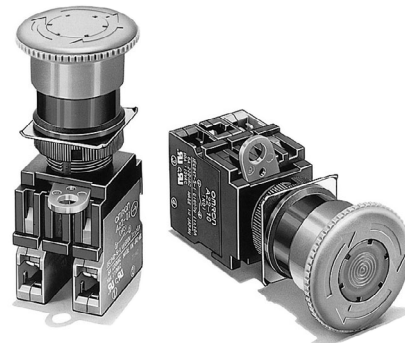

Model Number Structure

■ Model Number Legend

Completely Assembled

Shipped as a set which includes the Operation Unit, Lamp (lighted models only), and Switch.

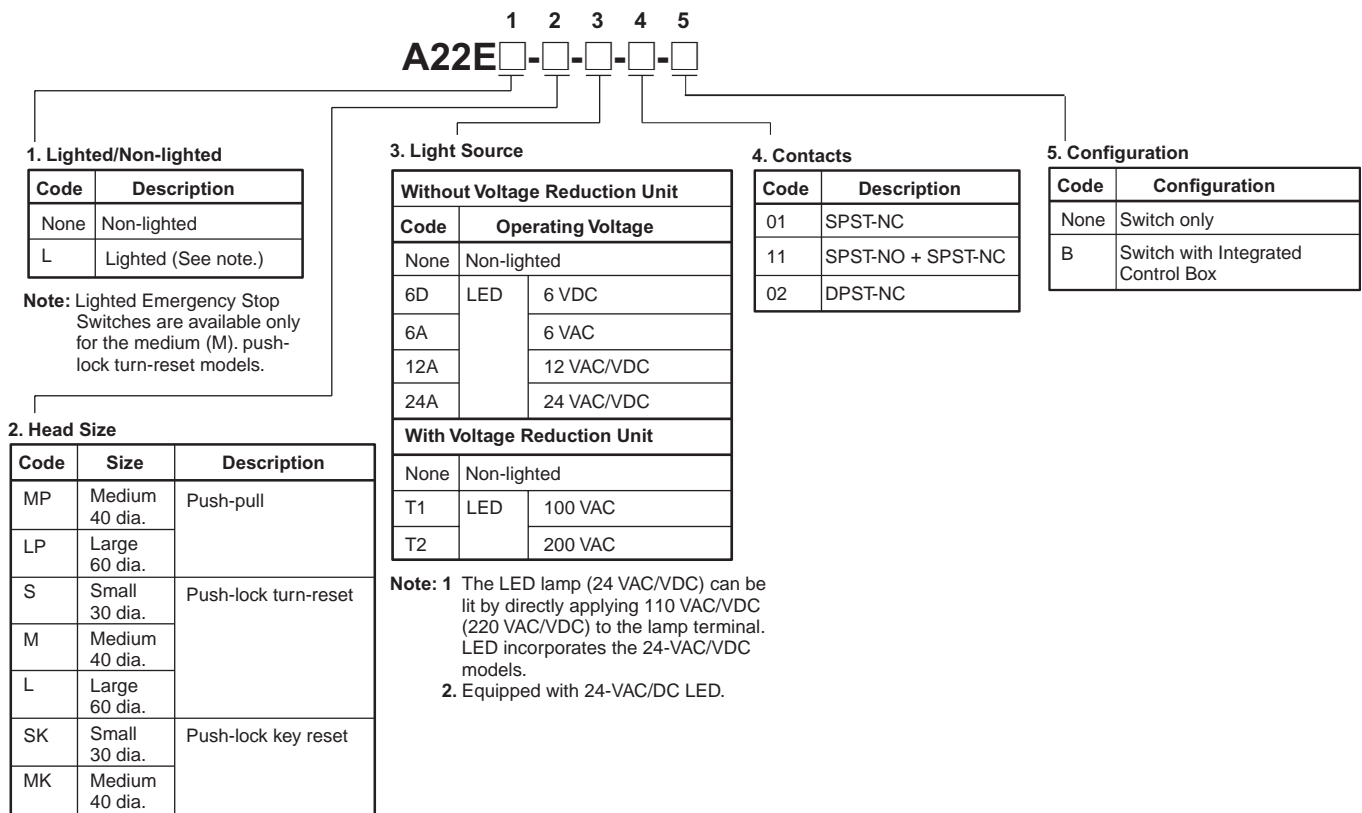

Subassembled

The Pushbutton, Lamp, or Switch can be ordered separately. Use them in combination for models that are not available as assembled Units. These can also be used as inventory for maintenance parts.

Unit Combinations

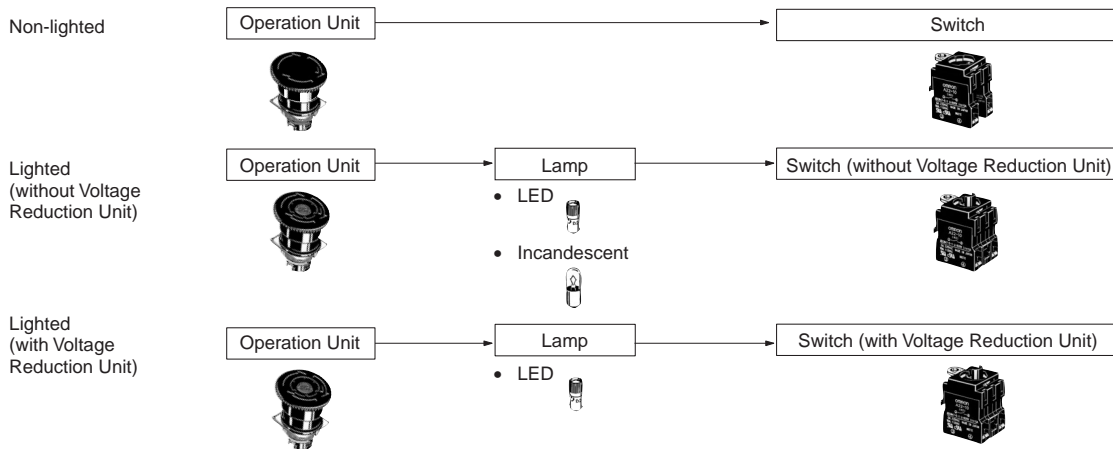

1. Operation Unit

Lighted/Non-lighted

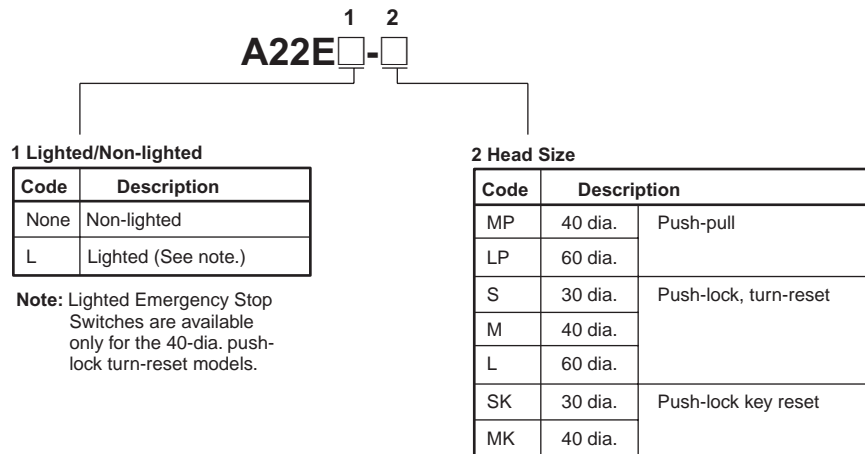

2. Lamp

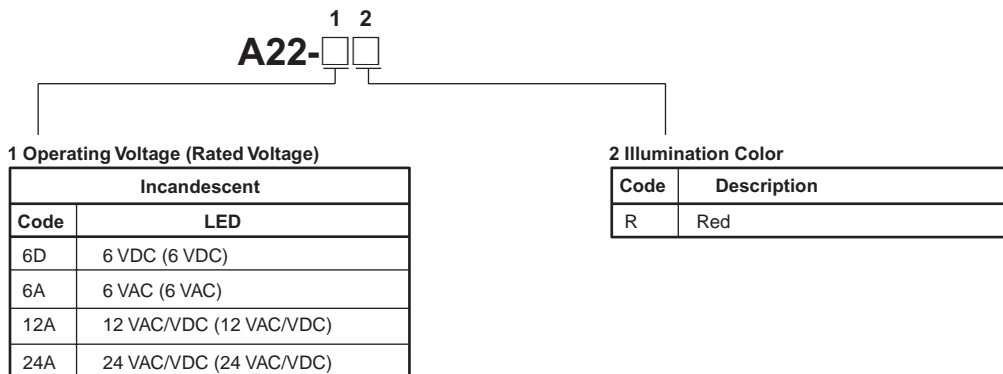

3. Switch

Lighted/Non-lighted

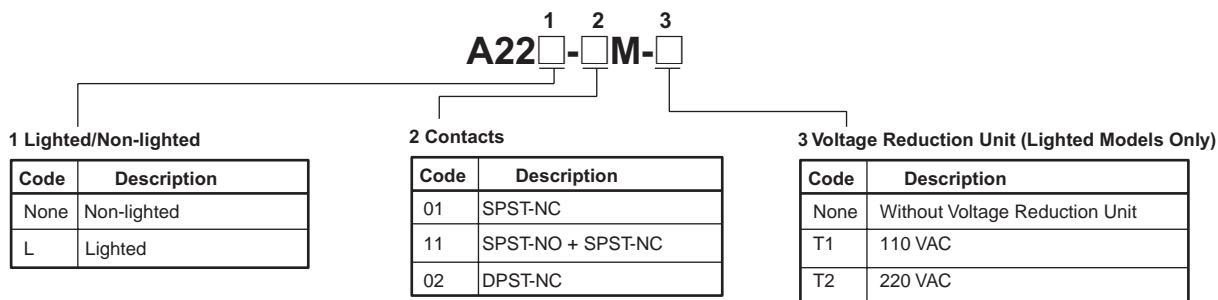







Note: Equipped with 24-VAC/DC LED.

Ordering Information

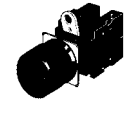

List of Models

Completely Assembled

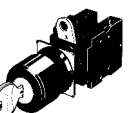
Non-lighted Models

Appearance		Output	Push-lock turn-reset system	Color of cap
40-dia. head Medium Push-pull A22E-MP		SPST-NC	A22E-MP-01	Red
		SPST-NO/SPST-NC	A22E-MP-11	
		DPST-NC	A22E-MP-02	
60-dia. head Large Push-pull A22E-LP		SPST-NC	A22E-LP-01	
		SPST-NO/SPST-NC	A22E-LP-11	
		DPST-NC	A22E-LP-02	
30-dia. head Small Push-lock Turn-reset A22E-S		SPST-NC	A22E-S-01	
		SPST-NO/SPST-NC	A22E-S-11	
		DPST-NC	A22E-S-02	
		DPST-NC + SPST-NO	A22E-S12	
		TPST-NC	A22E-S-03	
40-dia. head Medium Push-lock Turn-reset A22E-M		SPST-NC	A22E-M-01	
		SPST-NO/SPST-NC	A22E-M-11	
		DPST-NC	A22E-M-02	
		DPST-NC + SPST-NO	A22E-M-12	
		TPST-NC	A22E-M-03	
60-dia. head Large Push-lock Turn-reset A22E-L		SPST-NC	A22E-L-01	
		SPST-NO/SPST-NC	A22E-L-11	
		DPST-NC	A22E-L-02	
30-dia. head Small Push-lock Key-reset A22E-SK		SPST-NC	A22E-SK-01	
		SPST-NO/SPST-NC	A22E-SK-11	
		DPST-NC	A22E-SK-02	
40-dia. head Medium Push-lock Key-reset A22E-MK		SPST-NC	A22E-MK-01	
		SPST-NO/SPST-NC	A22E-MK-11	
		DPST-NC	A22E-MK-02	

Lighted Models





Appearance	Output	Lighting	Rated voltage	Push-lock turn-reset system	Color of cap
40-dia. head Push-lock Turn-reset without voltage Reduction Unit 	SPST-NC	LED	6 VDC	A22EL-M-6D-01	Red
			6 VAC	A22EL-M-6A-01	
			12 VAC/VDC	A22EL-M-12A-01	
			24 VAC/VDC	A22EL-M-24A-01	
	SPST-NO/SPST-NC		6 VDC	A22EL-M-6D-11	
			6 VAC	A22EL-M-6A-11	
			12 VAC/VDC	A22EL-M-12A-11	
			24 VAC/VDC	A22EL-M-24A-11	
	DPST-NC		6 VDC	A22EL-M-6D-02	
			6 VAC	A22EL-M-6A-02	
			12 VAC/VDC	A22EL-M-12A-02	
			24 VAC/VDC	A22EL-M-24A-02	
40-dia. head Push-lock Turn-reset with Voltage Reduction Unit 	SPST-NC	110 VAC	A22EL-M-T1-01		
	SPST-NO/SPST-NC	220 VAC	A22EL-M-T2-01		
		110 VAC	A22EL-M-T1-11		
	DPST-NC	220 VAC	A22EL-M-T2-11		
		110 VAC	A22EL-M-T1-02		
		220 VAC	A22EL-M-T2-02		

Switch with Integrated Control Box

Appearance	Output	Model
	SPST-NC	A22E-M-01B
	SPST-NO/SPST-NC	A22E-M-11B
	DPST-NC	A22E-M-02B

Operation Units

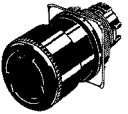
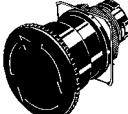
Non-lighted

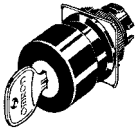
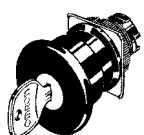
Sealing capability and size	IP65 oil-resistant models		
	Small (30 dia.)	Medium (40 dia.)	Large (60 dia.)
Push-pull	---	A22E-MP 	A22E-LP 
Push-lock, Turn-reset	A22E-S 	A22E-M 	A22E-L 
Push-lock, key-reset (push-lock, turn-reset)	A22E-SK 	A22E-MK 	---

Lighted

Sealing capability and size	IP65
	Medium (40 dia.)
Push-lock, Turn-reset	A22EL-M 

Lamp

LED

Appearance	LED light		Rated voltage	Model
	Red	Standard	6 VDC	A22-6DR
			6 VAC	A22-6AR
			12 VAC/VDC	A22-12AR
			24 VAC/VDC	A22-24AR
	Bright	24 VAC/VDC	A22-24ASR	

Note: For voltage-reduction lighting, use the A22-24AR.

Incandescent

Appearance	Rated voltage	Model
	6 VDC	A22-5
	14 VAC	A22-12
	28 VAC	A22-24
	130 VAC	A22-H1

Switch (Standard Load)

Without Voltage Reduction Unit













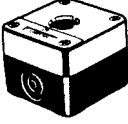

Contacts	Classification Appearance	Non-lighted	Lighted
		Momentary	Momentary
For standard loads	SPST-NO	A22-10M	A22L-10M
	SPST-NC	A22-01M	A22L-01M
	SPST-NO + SPST-NC	A22-11M	A22L-11M
	DPST-NO	A22-20M	A22L-20M
	DPST-NC	A22-02M	A22L-02M

With Voltage Reduction Unit

Contacts	Classification Appearance	Lighted (110 VAC)	Lighted (220 VAC)
		Momentary	Momentary
For standard loads	SPST-NO	A22L-10M-T1	A22L-10M-T2
	SPST-NC	A22L-01M-T1	A22L-01M-T2
	SPST-NO + SPST-NC	A22L-11M-T1	A22L-11M-T2
	DPST-NO	A22L-20M-T1	A22L-20M-T2
	DPST-NC	A22L-02M-T1	A22L-02M-T2

Note: 1. The above illustrations are for the DPST-NO contact.
 2. When using with a Voltage Reduction Unit, use the A22-24AR.

Accessories (Order Separately)

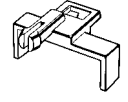
Item	Appearance	Classification	Model	Remarks	
Switch Blocks		SPST-NO	A22-10	Provided as standard. Order Switch Blocks only when adding or replacing them.	
		SPST-NC	A22-01		
		DPST-NO, one-piece	A22-20		
		DPST-NC, one-piece	A22-02		
Lamp Sockets		Direct lighting	A22-TN	Used when changing the lighting method.	
		Voltage-reduction lighting	100 VAC		A22-T1
			220 VAC		A22-T2
Mounting Latches		---	A22-3200	Provided as standard. Order Mounting Latches only when mounting Switch Blocks or Lamp Sockets that are purchased individually.	
Lock Ring		Rounded shape	A22Z-3360	The body is equipped with a Lock Fitting. This Lock Fitting is used when a more secure lock feature is required. (Refer to page 194.)	
Hole Plug		Round	A22Z-3530	Can be plugged into pre-cut panel holes for future expansion. The color is black.	
Control Boxes (Enclosures)		One hole, yellow box (for emergency stop)	A22Z-B101Y	Material: Polycarbonate resin	
Operation Keys		---	A22K-K	Two keys are provided.	
Connectors		Applicable cable diameter (mm)	7 to 9 dia.	A22Z-3500-1	Plastic connector used to extend a cable from the Switch Box.
			9 to 11 dia.	A22Z-3500-2	
25-dia. Ring		---	A22Z-R25	Can be fit into a 25-dia. hole in the panel. Since this is not attached to the main body, order separately. (Refer to page 194.)	
30-dia. Resin Attachment		---	A22Z-A30	Can be fit into a 30-dia. hole in the panel. (Refer to page 194.)	
Legend Plates for Emergency Stop		60-dia. black letters on yellow back-ground	A22Z-3466-1	"EMERGENCY STOP" is indicated on the plate.	
		90-dia. black letters on yellow back-ground	A22Z-3476-1		
		60-dia. black letters on yellow back-ground	A22Z-3466-2	"EMERGENCY OFF" is indicated on the plate.	
Lamp Extractor		---	A22Z-3901	Rubber tool used to replace Lamps easily	
Tightening Tool		---	A22Z-3905	Tool used to tighten nuts from the back of the panel and to attach caps to lighted models.	
Lock Plate		---	A22Z-3380	Use to fix the lever on the Switch.	

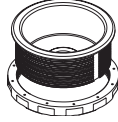
Item	Appearance	Classification	Model	Remarks
E-stop Shroud (See note.)		---	A22Z-EG1	The SEMI S2-compatible Shroud and legend plate for EMERGENCY OFF come as a set. Use with an A22E Emergency Stop Switch.
E-stop Shroud (See note.)		---	A22Z-EG2	SEMI-S2/SEMATECH Application Guide for SEMI 2S-compatible Shroud. Used together with an A22E Emergency Stop Pushbutton.

Note: These E-stop Shrouds are designed for use only in semiconductor manufacturing equipment. Do not use them for any other application.

Specifications

■ Certified Standards

Certification body	Standards	File No.
UL (See note 2.)	UL508	E41515
TÜV Product Service	EN60947-5-1, EN60947-5-5 (certified direct opening mechanism)	Inquire
CQC (CCC)	GB14048.5	2003010303070635
KOSHA (See note 3.)	EN60947-5-1	2004-220

- Note:**
- Only models with NC contacts have a direct opening mechanism.
 - UL-certification for CSA C22.2 No. 14 and bears the  mark.
 - Some models have been certified. Contact your OMRON sales representative.

■ Certified Standard Ratings

- UL, cUL (File No.E41515)
6A at 220 VAC, 10 A at 110 VAC
- TÜV (EN60947-5-1) (Low Voltage Directive)
3 A at 220VAC
- CCC (GB14048.5)
3 A at 240 VAC, 1.5 A at 24 VDC

■ Ratings

Contacts (Standard Load)

Rated carry current	Rated voltage	Rated current (A)			
		AC15 (inductive load)	AC12 (resistive load)	DC13 (inductive load)	DC12 (resistive load)
10	24 VAC	10	10	---	---
	110 VAC	5	10		
	220 VAC	3	6		
	380 VAC	2	3		
	440 VAC	1	2		
	24 VDC	---	---	1.5	10
	110 VDC			0.5	2
	220 VDC			0.2	0.6
	380 VDC			0.1	0.2

- Note:**
- Rated current values are determined according to the testing conditions. The above ratings were obtained by conducting tests under the following conditions.
 - Ambient temperature: 20±2°C
 - Ambient humidity: 65±5%
 - Operating frequency: 20 operations/minute
 - Minimum applicable load: 10 mA at 5 VDC

LED Indicators without Voltage Reduction Unit

Rated voltage	Rated current	Operating voltage
6 VDC	60 mA	6 VDC±5%
6 VAC	60 mA	6 VAC/VDC±5%
12 VAC/VDC	30 mA	12 VAC/VDC±5%
24 VAC/VDC	15 mA	24 VAC/VDC±5%

■ Characteristics

Item		Emergency Stop Switches	
		Non-lighted model: A22E	Lighted model: A22EL
Allowable operating frequency	Mechanical	30 operations/minute max. (See note 3.)	
	Electrical	30 operations/minute max. (See note 3.)	
Insulation resistance		100 MΩ min. (at 500 VDC)	
Dielectric strength		2,500 VAC, 50/60 Hz for 1 min between terminals of same polarity 2,500 VAC, 50/60 Hz for 1 min between terminals of different polarity and also between each terminal and ground	
Vibration resistance		Malfunction (See note 2.): 10 to 55 Hz, 1.5-mm double amplitude	
Shock resistance	Mechanical	1,000 m/s ²	
	Malfunction (See note 2.)	250 m/s ² max.	
Durability	Mechanical	Momentary operation: 300,000 operations min. (See note 3.)	
	Electrical	300,000 operations min. (See note 3.)	
Ambient temperature (See note 1.)		Operating: -20°C to 70°C Storage: -40°C to 70°C	Operating: -20°C to 55°C Storage: -40°C to 70°C
Ambient humidity		Operating: 35% to 85%	
Degree of protection		IP65 (oil-resistant) (See note 4.)	IP65 (See note 4.)
Electric shock protection class		Class II	
PTI (tracking characteristic)		175	
Degree of contamination		3 (IEC60947-5-1)	

- Note:**
1. With no icing or condensation.
 2. Malfunction within 1 ms.
 3. Setting and resetting once is counted as one operation.
 4. The degree of protection from the front of the panel.

Nomenclature

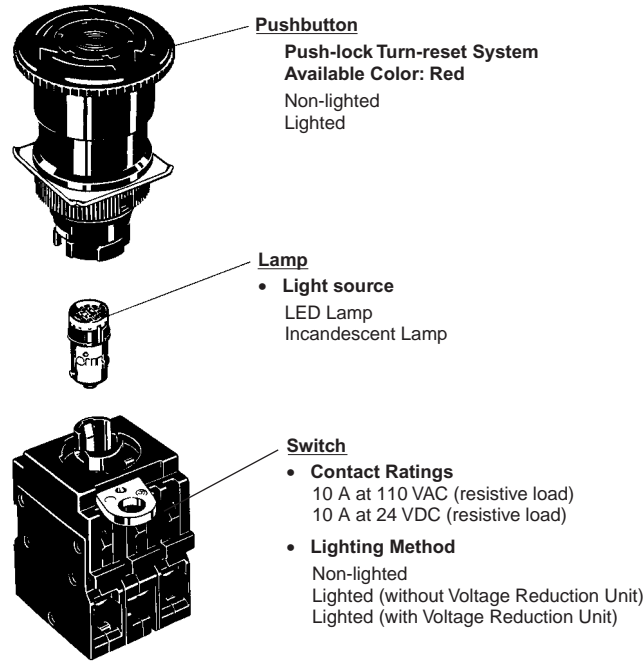

(The above figures are examples of the lighted model.)

Safety Lock Mechanism to Prevent Misuse

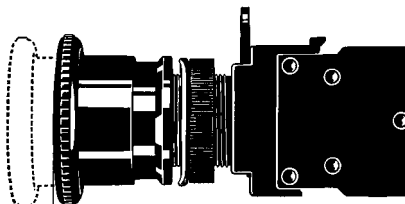

Lock position

This Switch can be intentionally used to stop equipment in an emergency. Even if an object or person touches the Pushbutton by mistake, the contact will not be released unless the Pushbutton reaches the lock position.

This Switch uses a finger protection mechanism to prevent electrical shocks. Moreover, it is provided with a mechanism to prevent terminal screws from coming off and also allows connection to either round or forked crimp terminals.

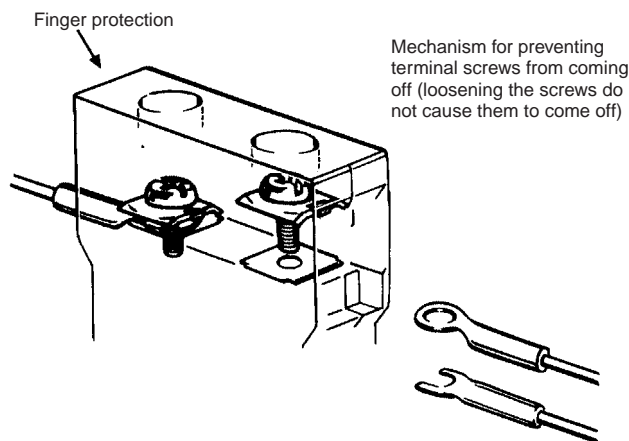

Dimensions

Note: All units are in millimeters unless otherwise indicated.

Non-lighted Models

A22E-MP

Medium Push-pull (40-dia.)

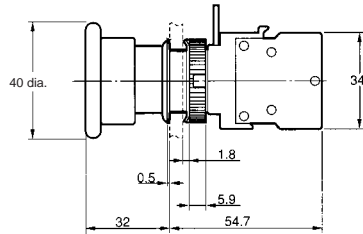
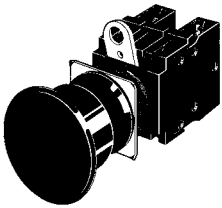

A22E-LP

Large Push-pull (60-dia.)

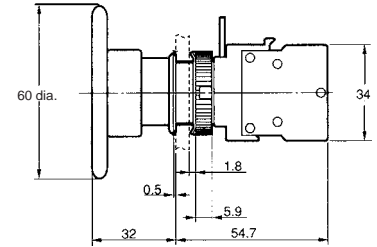
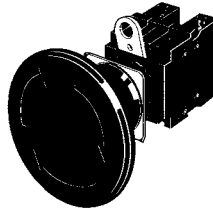

A22E-S

Small Push-lock, Turn-reset (30-dia.)

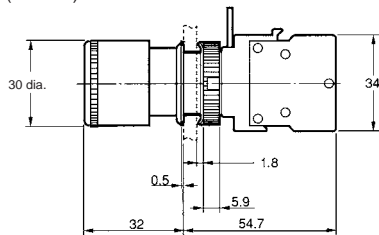
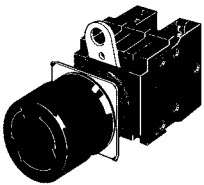

A22E-M

Medium Push-lock, Turn-reset (40-dia.)

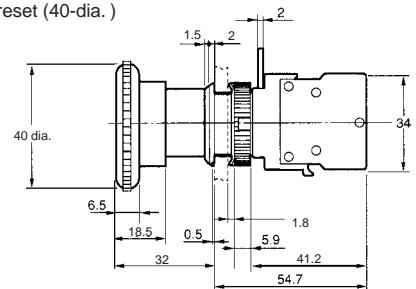
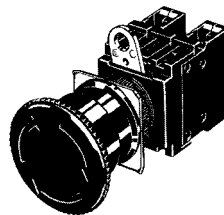

A22E-L

Large Push-lock, Turn-reset (60-dia.)

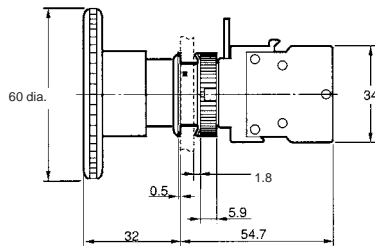
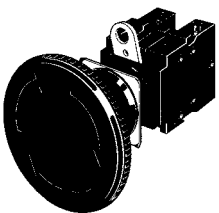

A22E-SK

Small Push-lock, Key-reset (30-dia.)

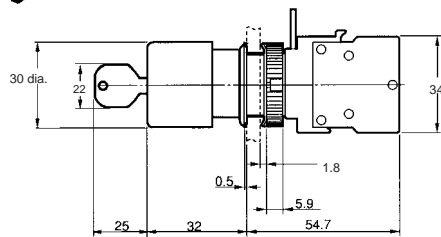
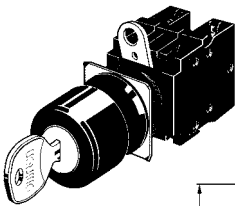

A22E-MK

Medium Push-lock, Key-reset (40-dia.)

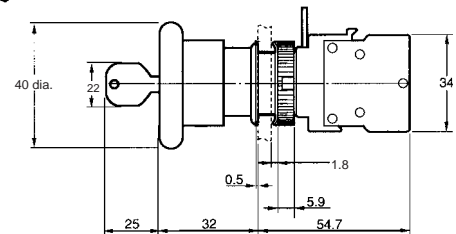
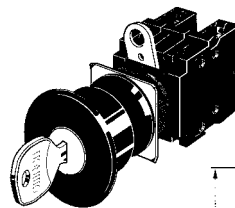

Lighted Models

A22EL-M

Medium Push-lock, Turn-reset (40-dia.)

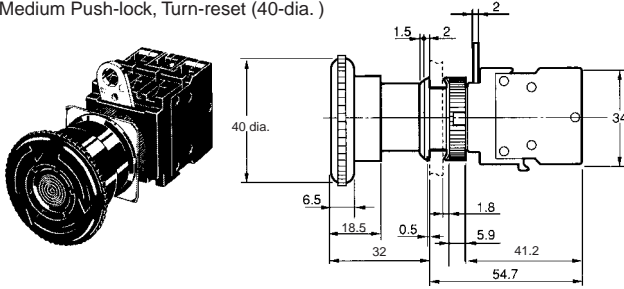

■ Dimensions for Accessories

Hole Plug

Round A22Z-3530

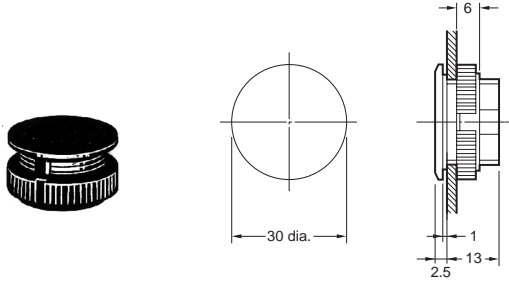

30-dia. Resin Attachment

A22Z-A30

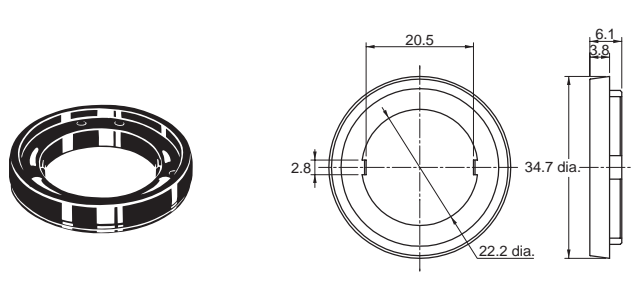

Legend Plates for Emergency Stop

A22Z-3466-1 (φ60)

A22Z-3476-1 (φ90)

A22Z-3466-2 (φ60)

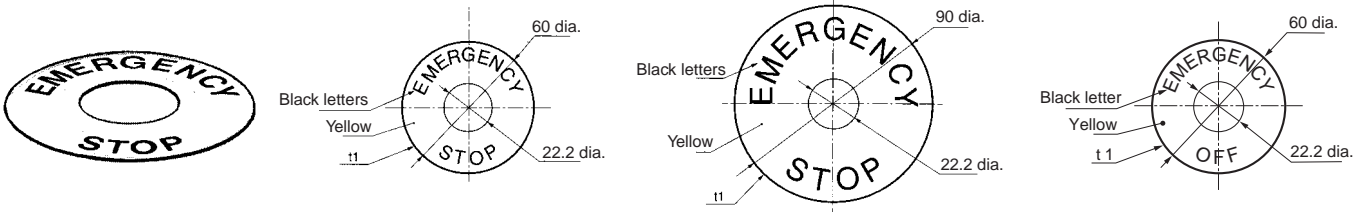

Lamp Extractor

A22Z-3901

Tightening Wrench

A22Z-3905

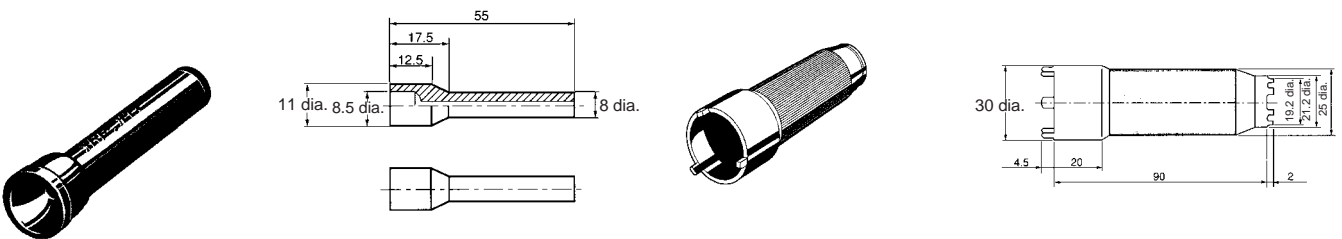

Material: Chloroprene rubber

Lock Ring

A22Z-3360

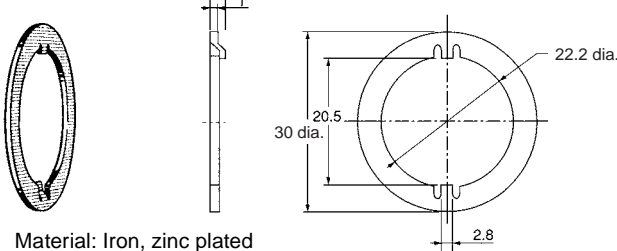

Material: Iron, zinc plated

25-dia. Ring

A22Z-R25

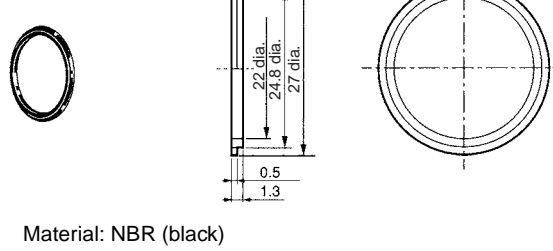

Material: NBR (black)

Lamp

LED A22-6□, 12□, 24□

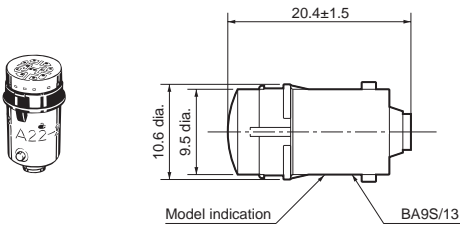

Incandescent Lamp A22-5, 12, 24, H1

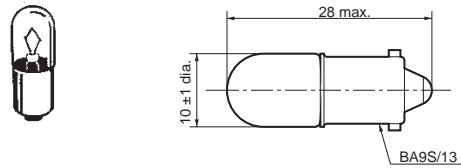

Control Box

A22Z-B101Y (1 hole)

Cable Draw-out Hole (Top View)

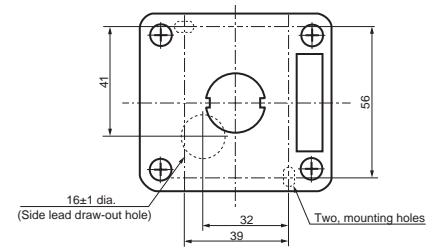
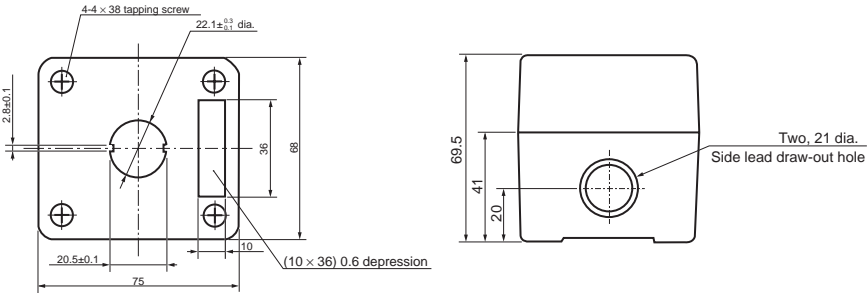

Lock Plate

A22Z-3380

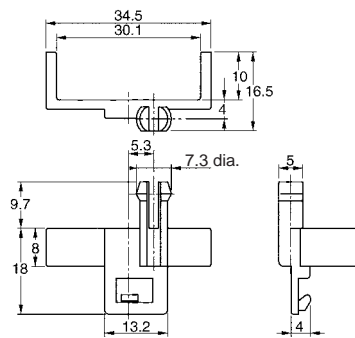
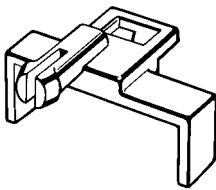

E-stop Shroud

A22Z-EG1

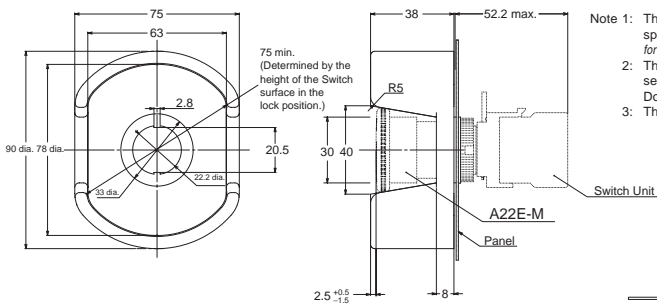

- Note 1: The dimensions of the Shroud conform to the specifications of the SEMATECH Application Guide for SEM S2-93.
- Note 2: These Shrouds are designed for use only in semiconductor manufacturing equipment. Do not use them for any other application.
- Note 3: The Shroud is not provided with the Switch.



Panel Cutout Dimensions
Allowable panel thickness: 1 to 3 mm

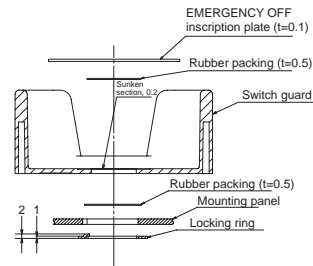

E-stop Shroud

A22Z-EG2, A22Z-EG21, A22Z-EG22

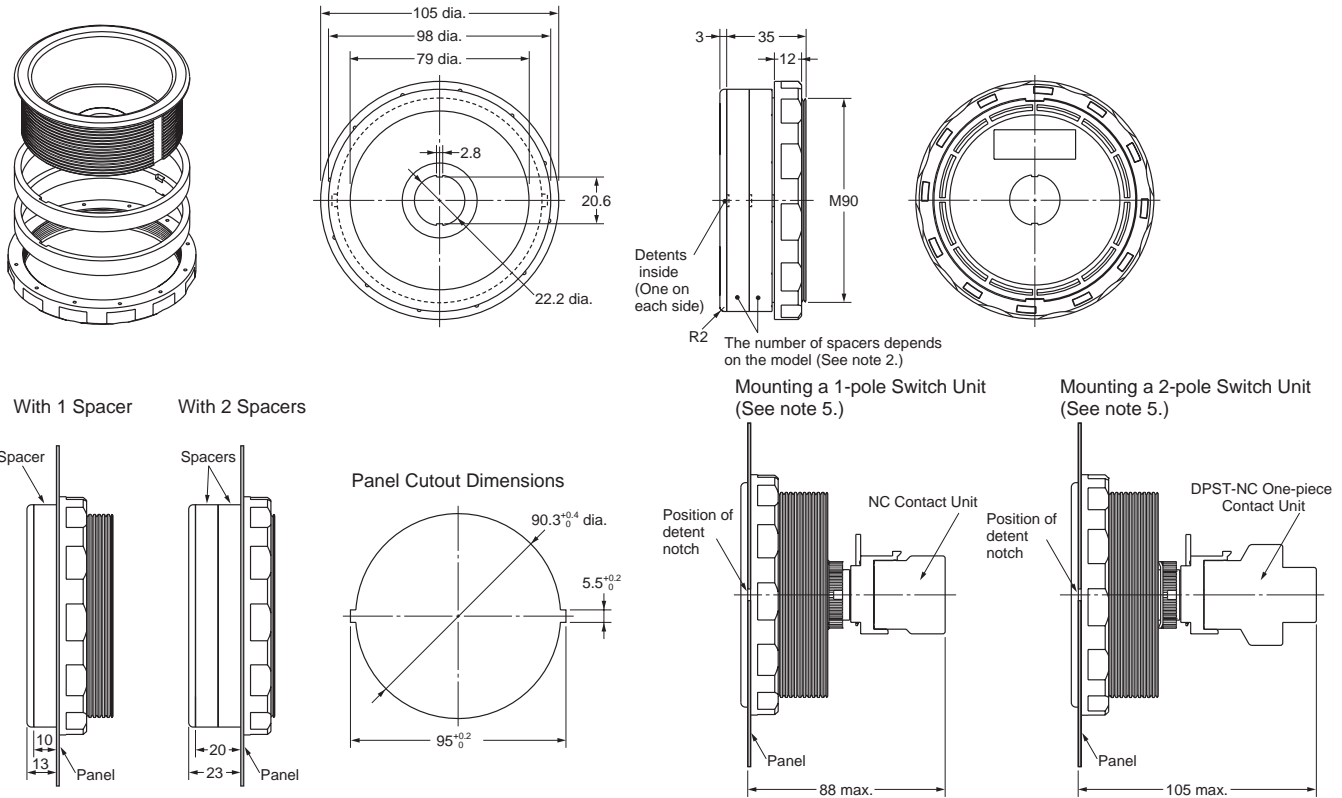

- Note:**
1. These Shrouds are designed for use only in semiconductor manufacturing equipment. Do not use them for any other application.
 2. The number of Spacers that are combined depends on the model.

Model	No. of Spacers
A22Z-EG2	0
A22Z-EG21	1
A22Z-EG22	2

3. Tighten to a torque of 1.96 to 2.94 N·m.
4. The allowable panel thicknesses are as follows:
 Without Spacers: $t=1.3$ to 22.5 mm
 With 1 Spacer: $t=1.3$ to 12.5 mm
 With 2 Spacers: $t=1.3$ to 2.5 mm
5. These are the dimension from the front of the panel when the Switch Unit is attached.

Terminal Arrangement

Terminal Arrangement (Bottom View)

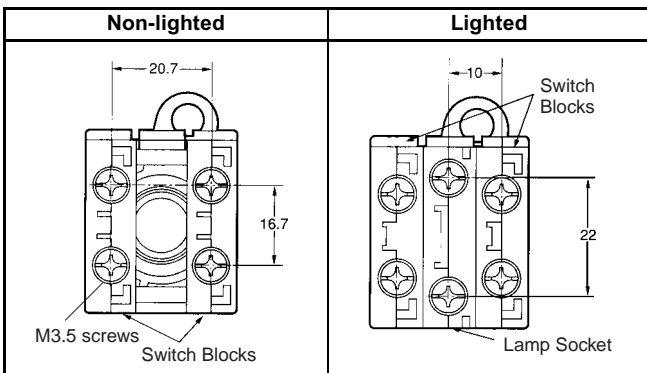

Terminal Connection

Type	Terminal connection (BOTTOM VIEW)	
	SPST-NO + SPST-NC	DPST-NC
Non-lighted		
Lighted without Voltage Reduction Unit		
Lighted with Voltage Reduction Unit		

Note: The above terminal connection diagrams are examples for SPST-NO + SPST-NC and DPST-NC.

Panel Cutouts

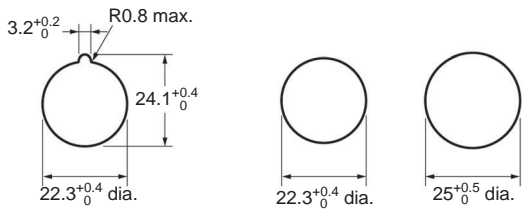

With Lock Fitting

Without Lock Fitting

A Lock Ring is provided as a standard feature.

- Note:**
- When painting or coating the panel, make sure that the specified panel dimensions apply to the panel after painting or coating.
 - Use an A22Z-R25 Ring when mounting to a panel with a 25-mm diameter hole.

Installation

Mounting to the Panel

Preparing the Panel

- The panel dimensions are shown below.
- The panel thickness must be 1 to 5 mm.

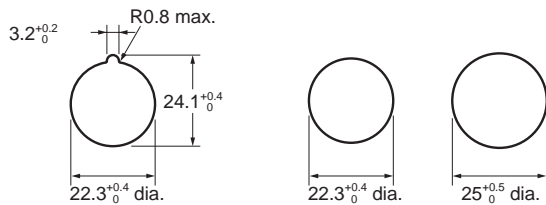

With Lock Ring

Without Lock Ring

- Always use a 25-mm-dia. Lock Ring for a 25-mm-dia. hole. IP65 degree of protection will be lost if the 25-mm-dia. Lock Ring is not used because of the larger size of a 25-mm-dia. hole.
- When painting or coating the panel, make sure that the specified panel dimensions apply to the panel after painting or coating.

Mounting the Operation Unit on the Panel

Insert the Operation Unit (Pushbutton) from the front surface of the panel, insert the Lock Ring and the mounting nut from the terminal side, then tighten the nut. Before tightening, check that the rubber washer is present between the Operation Unit and the panel.

When using a Legend Plate Frame, put one rubber washer each between the Legend Plate Frame and the panel and between the Operation Unit and the Legend Plate Frame. (One rubber washer will be provided when one Legend Plate Frame is ordered.)

Align the Lock Ring with the groove in the casing, then insert the Lock Ring so that its edge is located on the panel side.

Tighten the mounting nut at a torque of 0.98 to 1.96 N·m.

When using a Lock Ring, replace with the supplied Lock Ring, insert the projecting part into the lock slot, and then tighten the mounting nut.

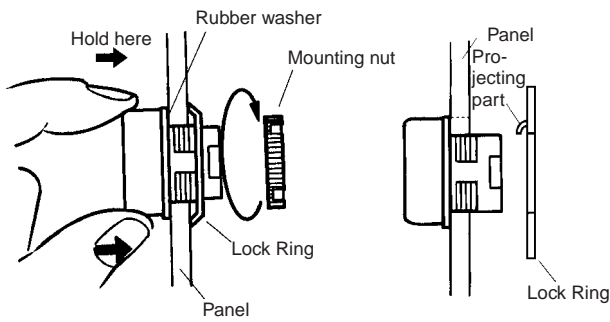

1. When the panel cutout dimension is 25 dia., remove the supplied rubber washer and mount the 25-dia. Ring as shown below. (Since the A22Z-R25 is not attached to the main body, order separately.)

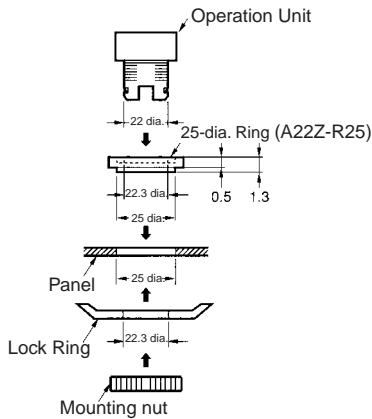

2. When the panel cutout dimension is 30 dia., the A22Z-A30 Attachment is not attached to the main body, order separately.

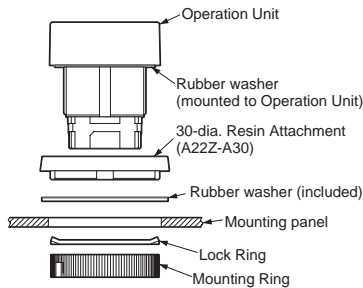

Matrix Mounting

1. The following diagram provides the dimensions for mounting individual Switches, Legend Plates, and Lock Rings with leads connected directly to Switch terminals.

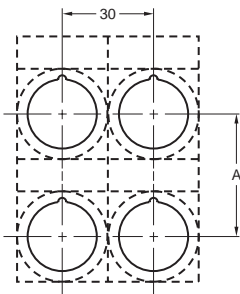

2. The following diagram provides the dimensions for mounting Large Legend Plates with crimp terminals connected to Switch terminals.

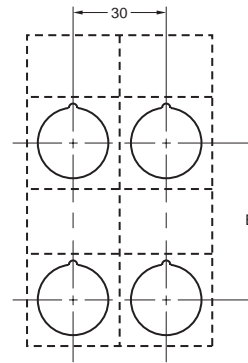

Dimensions A and B between mounting hole centers are given in the following tables.

For 1., Above

Switch model	Dimension A
A22-10, A22-10S, A22-01, A22-01S	45 mm min.
A22-20, A22-20S, A-22-02, A22-02S, A22-11, A22-11S	55 mm min.

For 2., Above

Type of crimp terminal	Switch model	Dimension B
Naked crimp terminals	A22-10, A22-10S, A22-01, A22-01S	51 mm min.
	A22-20, A22-20S, A22-02, A22-02S, A22-11, A22-11S	61 mm min.
Crimp terminals with insulating sheaths	A22-10, A22-10S, A22-01, A22-01S	60 mm min.
	A22-20, A22-20S, A22-02, A22-02S, A22-11, A22-11S	70 mm min.

Note: 1. The above dimensions are the minimum dimensions when using the applicable wiring materials listed on page 201. If any other materials are used, check the suitability of dimensions in advance.

2. When using pushbuttons exceeding 30 mm, adjust dimension A or B accordingly. (When mounting the A22-M□ in a matrix, "30 mm" would have to be increased to 40 mm.)

Mounting the Switch on the Operation Unit

Insert the Operation Unit into the Switch Unit, aligning the arrow mark inscribed on the Case with the lever on the Switch Blocks, then move the lever in the direction indicated by the arrow in the following figure.

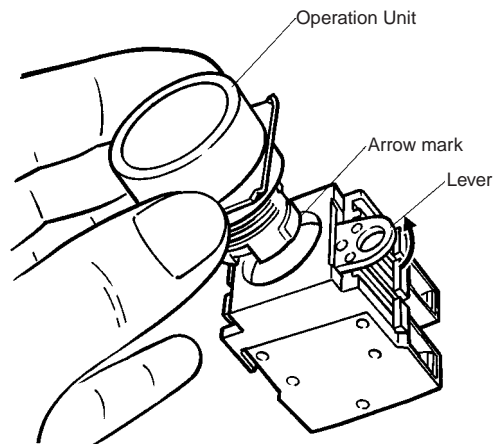

Removing the Switch

Move the lever in the direction indicated by the arrow in the following figure, then pull the Operation Unit or the Switch Blocks.

Since the lever has a hole with an inside diameter of 6.5 mm, the lever can be moved in the specified direction by inserting a screwdriver into the hole and then moving the screwdriver.

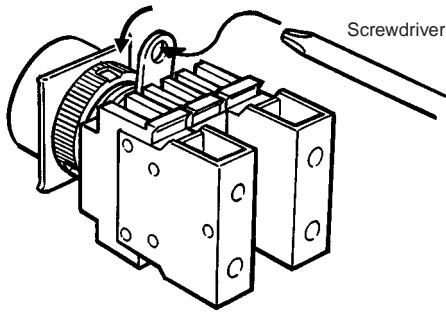

■ Assembling the Cap Emergency Stop Switch

Insert the protrusion of the Tightening Wrench (A22Z-3905) into the Cap slot and then turn to remove the Cap.

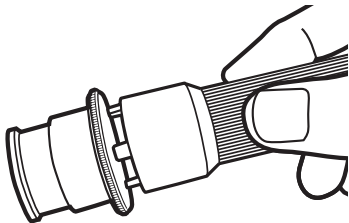

■ Installing/Replacing the Lamp Installing/Replacing from the Panel Surface

Insert the Lamp Extractor (A22Z-3901) into the lamp, then rotate the Extractor while pressing it.

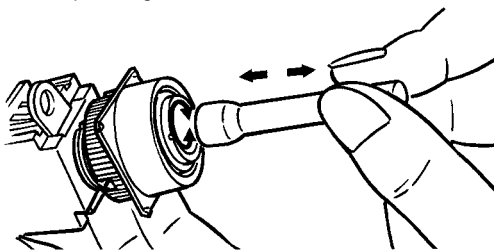

Installing/Replacing on the Switch

Grip the indicator with your fingers, then rotate the indicator while pressing it against the Switch.

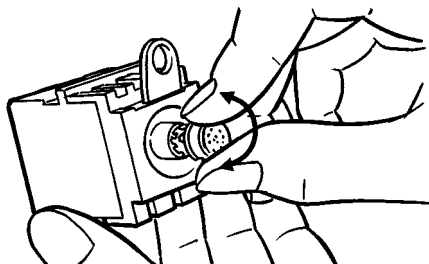

■ Control Box (Enclosure)

Mounting the Switch

The Standard-size Legend Plate Frame can be mounted. Mount the Frame as shown in the following diagram. Mount the Switch in the same way as for an ordinary panel.

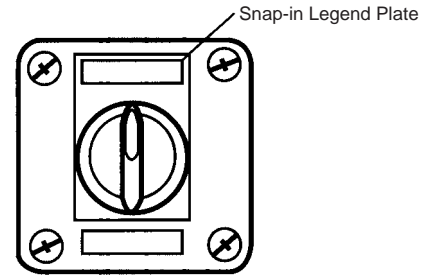

Creating a Cable Port Hole

Place the tip of a screwdriver on the surface where the cable port hole is to be created with the cover attached and strike the screwdriver to punch a hole. Attempts to punch a hole on the other side of the case will damage the Box.

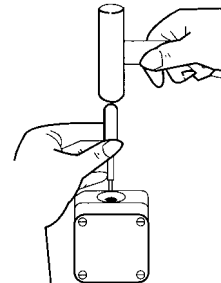

Securing the Connector Cable

1. Insert the connector into the cable port hole in the Box and secure with the fixing nut inside the box.
2. Open a hole in the thin rubber section of the rubber ring.
3. Pass the tightening cap through the cable, insert the cable into the connector, and tighten the hexagonal nut to secure the cable.

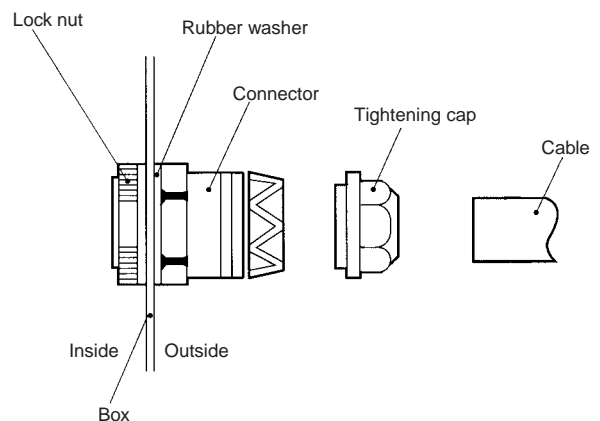

Cable diameter	Connector
7 to 9 dia.	A22Z-3500-1
9 to 11 dia.	A22Z-3500-2

■ Installing/Removing the Switch Blocks

Installing the Switch Blocks

Hook the small protrusion on the Mounting Latch into the groove on the other side of the lever, then push up the Switch Block in the direction indicated by the arrow in the figure below.

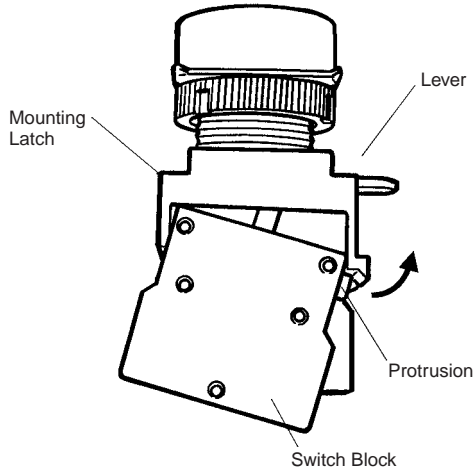

Removing the Switch Blocks

Insert a screwdriver between the Mounting Latch and the Switch Block, then push down the screwdriver in the direction indicated by the arrow in the following figure.

Use either of the following screwdrivers.

Flat-head screwdriver	3 to 6 mm	
Phillips screwdriver	3 to 6 mm dia.	

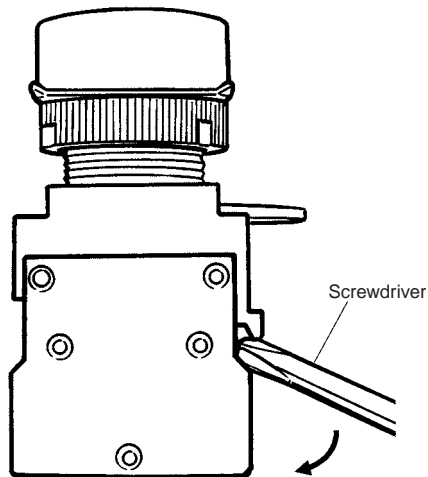

■ Wiring

Wiring Round Crimp Terminals

Loosen the terminal screw from the Switch Unit until it completely comes off the groove, insert a screwdriver as shown in the following figure, then push up the washer in the direction indicated by the arrow to temporarily secure it. Now, a round crimp terminal can be connected. After inserting the terminal, tighten the screws to complete wiring.

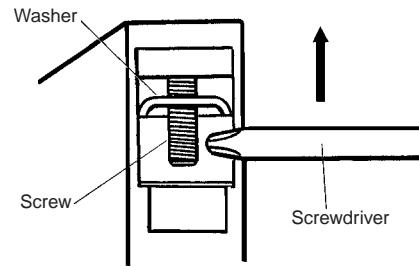

Safety Precautions

Refer to the *Common Precautions for Pushbutton Switches* on page 14.



Caution

Do not apply a voltage exceeding the rated voltage across the incandescent lamp terminals.
The lamp may be destroyed and the operation unit may fly out.

Precautions for Correct Use

Mounting

Always make sure that the power is turned OFF before mounting, removing, or wiring the Switch, or performing maintenance. Electric shock may occur.

Do not tighten the mounting ring more than necessary using tools such as pointed-nose pliers. Doing so will damage the mounting ring. The tightening torque is 0.98 to 1.96 N·m.

Recommended panel thickness: 1 to 5 mm.

Wiring

When DC-specific LEDs are used, wire the Switch so that the X1 terminal is positive.

Terminal screws must be Phillips or slotted M3.5 screws with a square washer.

The tightening torque is 1.08 to 1.27 N·m.

Single wires, stranded wires, and crimp terminals can be connected to the Switch.

Applicable Wiring Materials:

Twisted strands: 2 mm² max.

Solid wire: 1.6 mm dia.

Naked Crimp Terminals

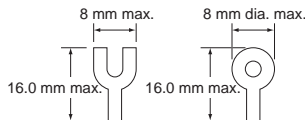

Crimp Terminals with Insulating Sheaths

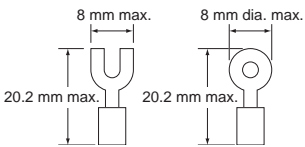

After wiring the Switch, maintain an appropriate clearance and creepage distance.

Operating Environment

The IP65 model is designed with a protective structure so that it will not sustain damage if it is subjected to water from any direction to the front of the panel.

Using the Microload

Contact failure may occur if a Switch designed for a standard load is used to switch a microload. Use Switches within the application ranges shown in the following graph. Even within the application range, insert a contact protection circuit, if necessary, to prevent the reduction of life expectancy due to extreme wear on the contacts caused by loads where inrush current occurs when the contact is opened and closed.

The minimum applicable load is the N-level reference value. This value indicates the malfunction reference level for the reliability level of 60% ($\lambda 60$) (conforming to JIS C5003).

The equation, $\lambda 60 = 0.5 \times 10^{-6}/\text{time}$ indicates that the estimated malfunction rate is less than 1/2,000,000 with a reliability level of 60%.

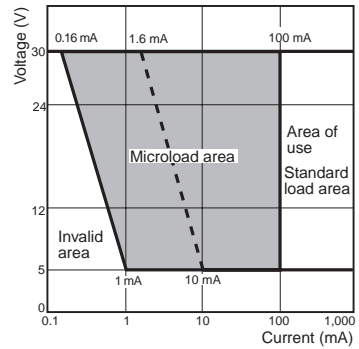

LEDs

The LED current-limiting resistor is built-in, so internal resistance is not required.

If commercially available LEDs are used, select the ones that meet the following conditions:

Base: BA9S/13□

Overall length: 26 mm max.

Power consumption: 2.6 W max.

Others

The oil-resistant IP65 uses NBR rubber and is resistant to general cutting oil and cooling oil. Some particular oils cannot be used with the oil-resistant IP65, however, so contact your OMRON representative for details.

If the panel is to be finished with coating, etc., make sure that the panel meets the specified dimensions after the coating.

Do not subject the Switch to extreme shock or vibration. Doing so will cause malfunctions and damage to the Switch.

Do not let sharp objects come into contact with the Switches that are made of resin. Doing so will damage the Switches, causing scratches on the outside of the Pushbuttons, and malfunction.

When handling the Switches, do not throw or drop them.

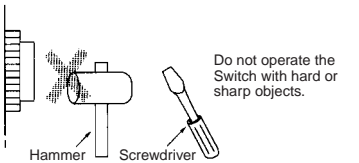
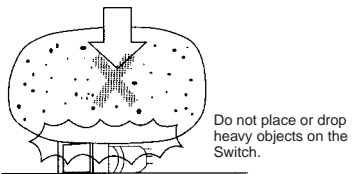
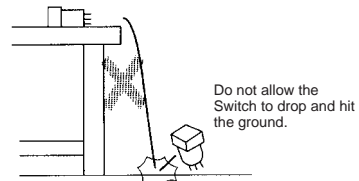

ALL DIMENSIONS SHOWN ARE IN MILLIMETERS.

To convert millimeters into inches, multiply by 0.03937. To convert grams into ounces, multiply by 0.03527.

Indicator M22

22-dia. and 25-dia. Round Indicator Series

- Easy mounting and removal of Socket Unit.
- Use 25-dia. ring to install in 25-dia. panel cutouts.
- Finger protection mechanism on Lamp provided as a standard feature.
- UL and cUL approved (File No. E41515)

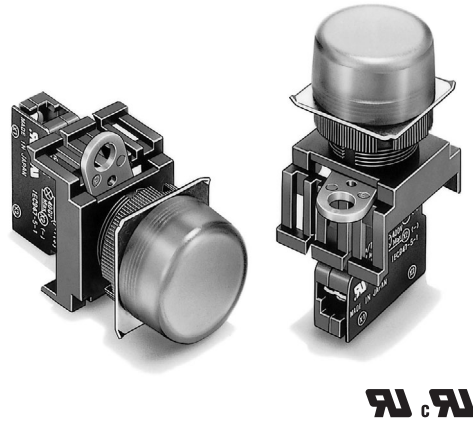

Model Number Structure

■ Model Number Legend

Completely Assembled

Shipped as a set which includes the Display, Lamp, and Socket Unit.

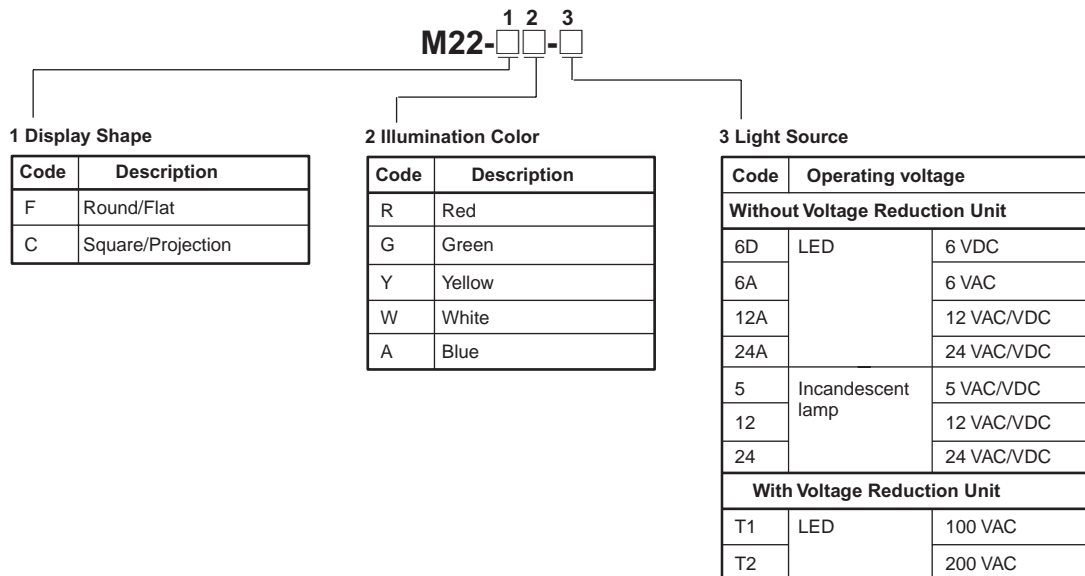

Note: The LED lamp (24 VAC/VDC) can be lit by directly applying 110 VAC/VDC (220 VAC/VDC) to the lamp terminal. LED incorporates the 24-VAC/VDC type.

Subassembled

The Display, Lamp, or Socket Unit can be ordered separately. Use them in combination for models that are not available as assembled Units. These can also be used as inventory for maintenance parts.

1. Display

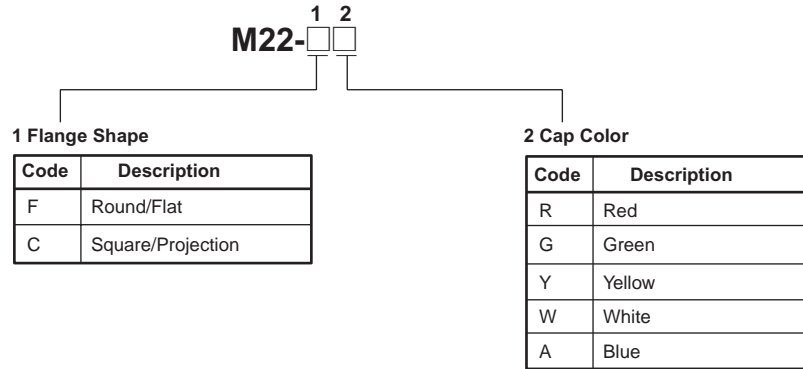

2. Lamp

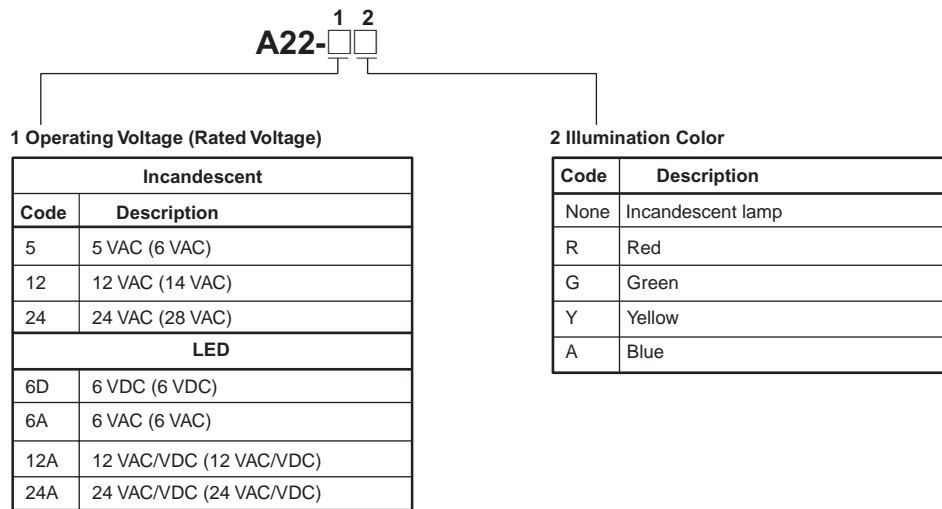

3. Socket Unit

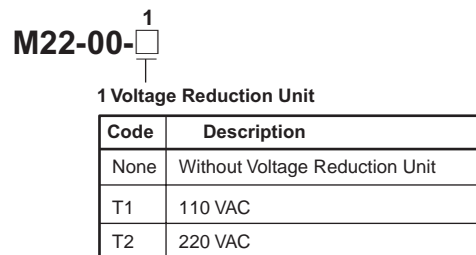



Ordering Information

■ List of Models

Completely Assembled

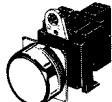
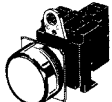
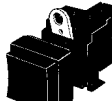

Indicator

Appearance	Lighting	Operating voltage	Model	Illumination color
Round/Flat without Voltage Reduction Unit  M22-F	LED	6 VDC	M22-F□-6D	Insert one of the following letters into the box □. R (red) Y (yellow) G (green) W (white) A (blue)
		6 VAC	M22-F□-6A	
		12 VAC/VDC	M22-F□-12A	
		24 VAC/VDC	M22-F□-24A	
Round/Flat with Voltage Reduction Unit  M22-F		100 VAC	M22-F□-T1	
		200 VAC	M22-F□-T2	
Square/Projection without Voltage Reduction Unit  M22-C		6 VDC	M22-C□-6D	
		6 VAC	M22-C□-6A	
	12 VAC/VDC	M22-C□-12A		
	24 VAC/VDC	M22-C□-24A		
Square/Projection with Voltage Reduction Unit  M22-C	100 VAC	M22-C□-T1		
	200 VAC	M22-C□-T2		

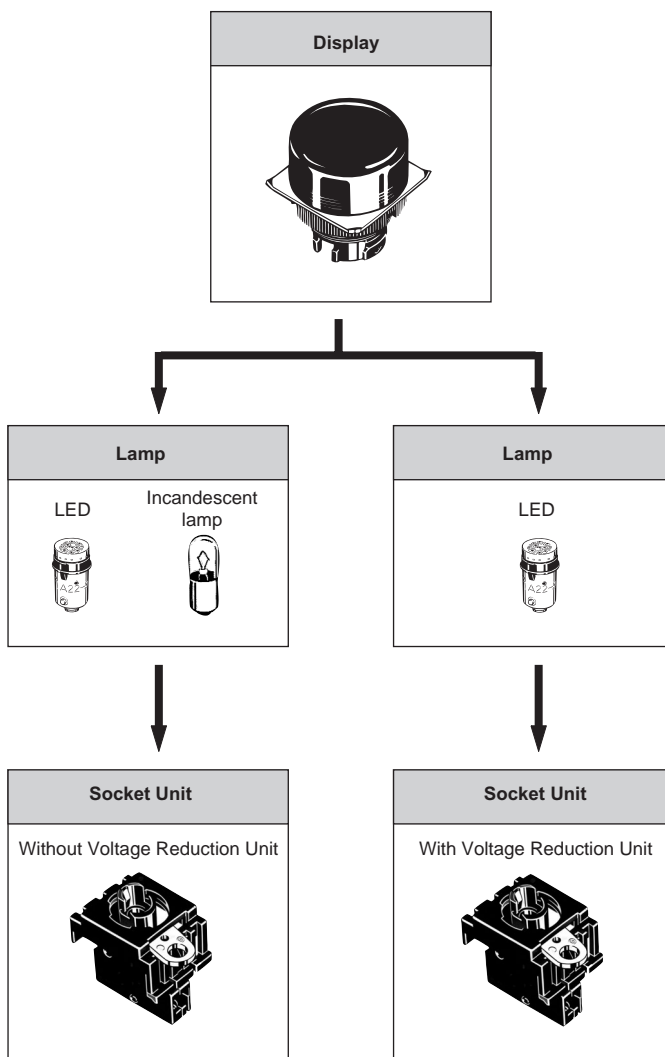
Subassembled



Display

Appearance	IP65 oil-resistant	
	Color of Display	Model
Round/Flat  M22-F	Red	M22-FR
	Green	M22-FG
	Yellow	M22-FY
	White	M22-FW
	Blue	M22-FA
Square/Projection  M22-C	Red	M22-CR
	Green	M22-CG
	Yellow	M22-CY
	White	M22-CW
	Blue	M22-CA

Lamp

LED

Appearance	Operating voltage		6 V	12 V	24 V	24 V Super-bright
	AC/DC	LED light	Model			
	AC	Red	A22-6DR	---	---	---
		Green	A22-6DG	---	---	---
		Yellow (see note 2)	A22-6DY	---	---	---
		Blue	A22-6DA	---	---	---
	DC	Red	A22-6AR	---	---	---
		Green	A22-6AG	---	---	---
		Yellow (see note 2)	A22-6AY	---	---	---
		Blue	A22-6AA	---	---	---
	AC and DC	Red	---	A22-12AR	A22-24AR	A22-24ASR
		Green	---	A22-12AG	A22-24AG	A22-24ASG
		Yellow (see note 2)	---	A22-12AY	A22-24AY	A22-24ASY
		Blue	---	A22-12AA	A22-24AA	A22-24ASA

Note: 1. For voltage-reduction lighting, use the A22-24A□.
 2. Used when the Display color is yellow or white.

Incandescent

Operating voltage	6 VAC/VDC	12 VAC/VDC	24 VAC/VDC
	A22-5	A22-12	A22-24

Socket Unit

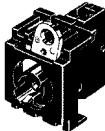
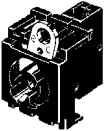
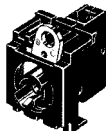
Voltage-reduction circuits		
Without Voltage Reduction Unit	With Voltage Reduction Unit	
		
Without Voltage Reduction Unit M22-00	With Voltage Reduction Unit (100 VAC) M22-00-T1	With Voltage Reduction Unit (200 VAC) M22-00-T2

Note: For voltage-reduction lighting, use the A22-24A□.

Accessories (Order Separately)

The M22 uses the same accessories as the A22. Refer to the relevant information in the corresponding section for the A22.

Specifications

■ Approved Standards

Recognized organization	Standards	File No.
UL, cUL (See note.)	UL508	E41515

Note: cUL: CSA C22.2 No. 14

■ Approved Standard Ratings

UL, cUL (File No. E41515)

2-6W, 120 V max.

■ Ratings

LED Lamp

Rated voltage	Rated current	Operating voltage
6 VDC	60 mA (20 mA)	6 VDC±5%
6 VAC	60 mA (20 mA)	6 VAC±5%
12 VAC/VDC	30 mA (10 mA)	12 VAC/VDC±5%
24 VAC/VDC	15 mA (10 mA)	24 VAC/VDC±5%

Note: The values in parentheses are for blue Indicators.

Super-bright LED Indicator

Rated voltage	Rated current	Operating voltage
24 VAC/VDC	15 mA	24 VAC/VDC±5%

Incandescent Lamp

Rated voltage	Rated current	Operating voltage
6 VAC/VDC	200 mA	5 V
14 VAC/VDC	80 mA	12 V
28 VAC/VDC	40 mA	24 V
130 VAC/VDC	20 mA	100 V

Voltage-reduction Lighting

Rated voltage	Operational voltage	Applicable lamp (BA9S/13□ gold)
110 VAC	95 to 115 VAC	LED lamp (A22-24□)
220 VAC	190 to 230 VAC	

■ Characteristics

Item	Indicator	
	M22	
Insulation resistance	100 MΩ min. (at 500 VDC)	
Dielectric strength	2,500 VAC, 50/60 Hz for 1 min between terminals of same polarity 2,500 VAC, 50/60 Hz for 1 min between terminals of different polarity and also between each terminal and ground	
Vibration resistance	Malfunction (See note 2.): 10 to 55 Hz, 1.5-mm double amplitude	
Shock resistance	Destruction	1,000 m/s ²
	Malfunction (See note 2.)	600 m/s ² max.
Ambient temperature (See note 1.)	Operating: -20°C to 55°C Storage: -40°C to 70°C	
Ambient humidity	Operating: 35°C to 85°C	
Degree of protection	IP65	
Electric shock protection class	Class II	
PTI (tracking characteristic)	175	
Degree of contamination	3 (IEC947-5-1)	

Note: 1. With no icing or condensation.
2. Malfunction within 1 ms.

Nomenclature

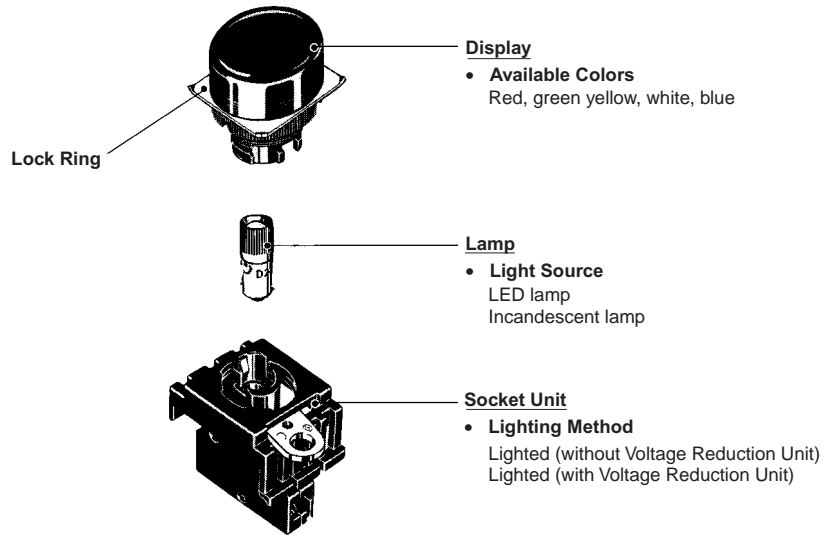

Dimensions

Note: All units are in millimeters unless otherwise indicated.

Indicators

Round/Flat

M22-F

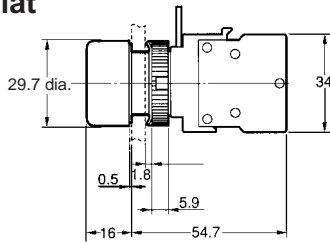

Square/Projection

M22-C

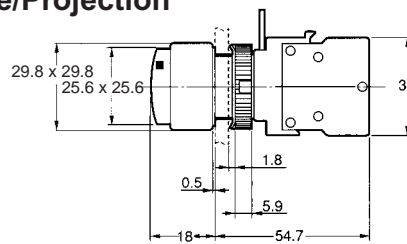

Accessories

The M22 uses the same accessories as the A22. Refer to the relevant information in the corresponding section for the A22.

Terminal Arrangement (Bottom View)

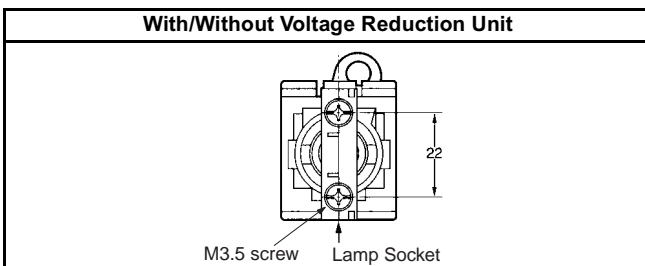

Terminal Connection

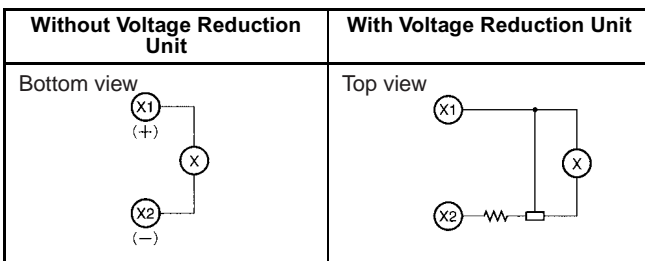

Panel Cutouts (Top View)



- Note:**
1. When applying coating such as paint to the panel, the dimensions should be those after the application of coating. Lock Ring is provided as a standard item.
 2. Recommended panel thickness: 1 to 5 mm.
 3. Use an A22Z-R25 Ring when mounting to a panel with 25-mm holes.

Installation

The M22 uses the same installation method as the A22. Refer to the relevant information in the *Installation* section for the A22.

Precautions

The precautions for the M22 are the same as those for the A22. Refer to the relevant information in the *Precautions* section for the A22 and the *Technical Information for Pushbutton Switches* (Cat. No. A143).

ALL DIMENSIONS SHOWN ARE IN MILLIMETERS.

To convert millimeters into inches, multiply by 0.03937. To convert grams into ounces, multiply by 0.03527.

Lighted Pushbutton Switch

A3A

Compact Switch Allows Signal and Power Switching with the Same Model

- Compact, high-capacity push-button switch that has contacts with a 3-mm gap and is ideal as a power switch.
- Capable of switching within the range of 1 mA, 5 VDC to 6 A, 125 VAC.
- Requires only 14.5 mm behind the panel.
- Options include the following:
 - Round or square
 - Momentary or alternate
 - Surface illumination or non-lighted
- UL and CSA approved.



Ordering Information

Model Number Legend

A 3 A A - 9 0 K 1 - 00E R

(1) Shape

Symbol	Protection
A	Square
T	Round

(2) Terminal

Symbol	Type
0	Solder
1	PCB

(3) Switch

Symbol	Operation	Contact type	
A (See note)	Momentary	SPDT	3 A at 125 VAC, 2 A at 30 VDC
B (See note)	Alternate		
K	Momentary	SPST-NO	6 A at 125 VAC, 2 A at 250 VAC, 4 A at 30 VDC
L	Alternate		

(4) Illumination

Symbol	Operation
00	Non-lighted
00E	Surface illumination

(5) Color

Pushbutton (Non-lighted Models)

Symbol	Color
L	Light gray
R	Red (See note)
Y	Yellow (See note)
G	Green (See note)
A	Blue
B	Black
D	Dark gray
H	Gray



LED (Surface Illumination Models)

Symbol	Color
R	Red
Y	Yellow
G	Green

Note: Common to both lighted and non-lighted models.

■ List of Models

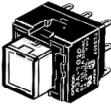
SPST-NO

Appearance	Terminal	Action	Illumination	Model	Color
Square A3AA-9□□1-00□ A3AA-9□□1-00E□ 	Solder	Momentary	Non-lighted	A3AA-90K1-00□	(Non-lighted)
			Surface illumination	A3AA-90K1-00E□	R: red
		Alternate	Non-lighted	A3AA-90L1-00□	Y: yellow
			Surface illumination	A3AA-90L1-00E□	G: green
	PCB	Momentary	Non-lighted	A3AA-91K1-00□	L: light gray (see note)
			Surface illumination	A3AA-91K1-00E□	A: blue (see note)
		Alternate	Non-lighted	A3AA-91L1-00□	B: black (see note)
			Surface illumination	A3AA-91L1-00E□	D: dark gray (see note)
Round A3AT-9□□1-00□ A3AT-9□□1-00E□ 	Solder	Momentary	Non-lighted	A3AT-90K1-00□	H: gray (see note)
			Surface illumination	A3AT-90K1-00E□	(Lighted)
		Alternate	Non-lighted	A3AT-90L1-00□	R: red
			Surface illumination	A3AT-90L1-00E□	Y: yellow
	PCB	Momentary	Non-lighted	A3AT-91K1-00□	G: green
			Surface illumination	A3AT-91K1-00E□	
		Alternate	Non-lighted	A3AT-91L1-00□	
			Surface illumination	A3AT-91L1-00E□	

Note: The above models each have a SPST-NO contact that can switch 6 A at 125 VAC, 2 A at 250 VAC, and 4 A at 30 VDC. When ordering any of the above models, replace □ of the model number with a code to indicate the pushbutton color of the model (i.e., replace □ with R, Y, G, L, A, B, D, H, and L). The pushbutton of an A3A does not illuminate if the color of the pushbutton is dark gray, gray, light gray, blue, or black.

SPDT

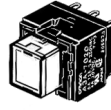
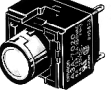



Appearance	Terminal	Action	Illumination	Model	Color
Square A3AA-9□□1-00□ A3AA-9□□1-00E□ 	Solder	Momentary	Non-lighted	A3AA-90A1-00□	R: red
			Surface illumination	A3AA-90A1-00E□	Y: yellow
		Alternate	Non-lighted	A3AA-90B1-00□	G: green
			Surface illumination	A3AA-90B1-00E□	L: light gray (see note)
	PCB	Momentary	Non-lighted	A3AA-91A1-00□	A: blue (see note)
			Surface illumination	A3AA-91A1-00E□	B: black (see note)
		Alternate	Non-lighted	A3AA-91B1-00□	D: dark gray (see note)
			Surface illumination	A3AA-91B1-00E□	H: gray (see note)
Round A3AT-9□□1-00□ A3AT-9□□1-00E□ 	Solder	Momentary	Non-lighted	A3AT-90A1-00□	(Lighted)
			Surface illumination	A3AT-90A1-00E□	R: red
		Alternate	Non-lighted	A3AT-90B1-00□	Y: yellow
			Surface illumination	A3AT-90B1-00E□	G: green
	PCB	Momentary	Non-lighted	A3AT-91A1-00□	
			Surface illumination	A3AT-91A1-00E□	
		Alternate	Non-lighted	A3AT-91B1-00□	
			Surface illumination	A3AT-91B1-00E□	

Note: The above models each have a SPDT contact that can switch 3 A at 125 VAC and 2 A at 30 VDC. When ordering any of the above models, replace □ of the model number with a code to indicate the pushbutton color of the model (i.e., replace □ with R, Y, G, L, A, B, D, H, and L). The pushbutton of an A3A does not illuminate if the color of the pushbutton is dark gray, gray, light gray, blue, or black.

■ Accessories (Order Separately)

Flange

Select according to panel color.

Name	Shape	Classification		Model
Flange	Square, 12.7 x 12.7 	Flange alone	Black	A3A-241
	Light gray		A3A-242	
	Round, 12.7 dia. 	Flange alone	Black	A3A-251
	Light gray		A3A-252	
		Leaf spring		A3A-200
	Square, 12.7 x 12.7 	Flange and leaf spring (one each)	Black	A3A-211
Light gray	A3A-212			
Round, 12.7 dia. 	Black		A3A-221	
		Light gray	A3A-222	

Note: An A3A with solder terminals is provided with a round or square black flange and leaf spring for the switching mechanism of the A3A. A round black flange is provided with each A3A having solder terminals and a round pushbutton. A square black flange is provided with each A3A having solder terminals and a square pushbutton.

Specifications

■ Contact Ratings

Type	Contact form	Resistive load	
High capacity	SPST-NO	6 A at 125 VAC 2 A at 250 VAC	4 A at 30 VDC

- Note:**
1. Minimum allowable load: 5 VDC 1 mA (Resistive)
 2. The ratings given above are for testing under the following conditions:
 1. Ambient temperature: 20 ±2°C
 2. Ambient humidity: 65 ±5%
 3. Operating frequency: 20 times/minute

■ LED Ratings

Item		Surface illumination		
		Red	Yellow	Green
Forward voltage V_F	Standard value	2.0 V	2.1 V	2.1 V
	Maximum value	3 V		
Forward current I_F	Standard value	10 mA		
	Maximum value	20 mA	25 mA	25 mA
Permissible loss PD	Absolute max. value	60 mW	75 mW	75 mW
Reverse voltage V_R	Absolute max. value	3 V		

- Note:**
1. The above built-in LEDs do not have a resistor. Connect to each of the above built-in LEDs a resistor that satisfies the above conditions.
 2. Refer to the $V_F - I_F$ characteristic graphs on page 219.

■ Characteristics

Operating frequency	Mechanical: Momentary action: 120 operations/minute max. Alternate action: 60 operations/minute max. (See note 1.) Electrical: 20 operations/minute max.
Insulation resistance	100 MΩ min. (at 500 VDC)
Contact resistance	100 mΩ max. (initial value)
Dielectric strength	600 VAC, 50/60 Hz for 1 min between terminals of same polarity 2,000 VAC, 50/60 Hz for 1 min between each terminal and ground 600 VAC, 50/60 Hz for 1 min between LED terminals (See note 2.)
Vibration resistance	Malfunction: 10 to 55 Hz, 1.5-mm double amplitude (See note 3.)
Shock resistance	Destruction: 500 m/s ² Malfunction: 150 m/s ² (See note 3.)
Life expectancy	Mechanical: Momentary action: 1,000,000 operations min. Alternate action: 50,000 operations min. (See note 1.) Electrical: 50,000 operations min.
Weight	Approx. 3.2 g
Ambient temperature	Operating: -10°C to 55°C (with no icing) Storage: -25°C to 65°C
Ambient humidity	Operating: 35% to 85%
Degree of protection	IP00
Electric shock protection class	Class II
PTI (proof tracking index)	175
Pollution degree	3 (IEC947-5-1)

- Note:**
1. With alternate-action models, a setting and resetting is regarded as one operation.
 2. The figure for the dielectric strength between LED terminals in the above table is for when the LED is not installed in the Switch.
 3. The figures for malfunctions in the above table are for malfunctions of at least 1 ms.

■ Approved Standards

UL (File No. E41515)/CSA (File No. LR45258)

SPST-NO: 6 A at 125 VAC, 2 A at 250 VAC, 4 A at 30 VDC
SPDT: 3 A at 125 VAC, 2 A at 30 VDC

■ Operating Characteristics

OF max.	2.45 N
RF min.	0.15 N
TT	Approx. 2 mm
PT max.	1.5 mm
LTA min. (See note.)	0.5 mm

Note: The above lock stroke figure applies to A3A alternate operation models only.

Nomenclature

Pushbutton

Square (A3AA)

Round (A3AT)



Diffusion sheet (milky white)

Flange

Leaf spring

Color cap

Color

Non-lighted Model

Red, yellow, light gray, gray, dark gray, green blue, black

Surface Illumination Model

Red, yellow, green

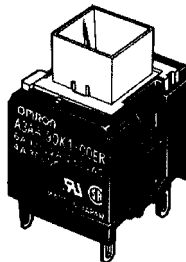

Switch

Ratings (Standard load)

- 6 A at 125 VAC
- 2 A at 250 VAC
- 4 A at 30 VDC
- Minimum applicable load:
1 mA at 5 VDC (resistive load)

Terminals

- Solder terminal
- PCB terminal

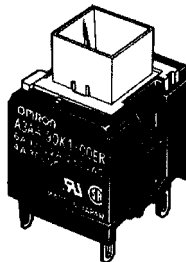

■ Contact Form

Contact Type

Contact form	Contact type
SPST-NO	
SPDT	

- Note:**
1. The above is for the A3AA.
 2. An A3A with solder terminals is provided with a black flange and leaf spring for the switching mechanism, however an A3A with PCB terminals is not provided with them. If a black flange and leaf spring are required for an A3A with PCB terminals, order them from your OMRON representative.

Dimensions

- Note:** 1. All units are in millimeters unless otherwise indicated.
 2. The illustrations below show switches with solder terminals, without a flange or leaf spring.

Non-lighted Model

Square Pushbutton

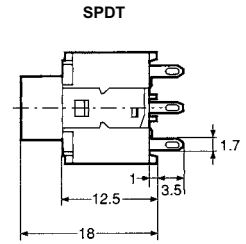
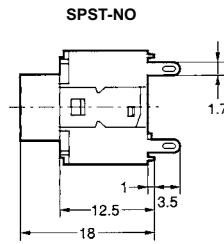
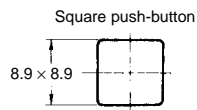
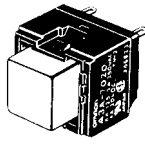

Round Pushbutton

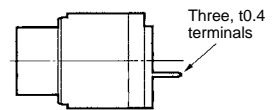
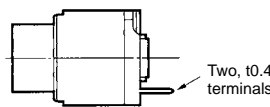
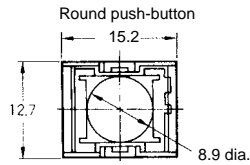
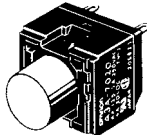

Surface Illumination Model

Square Pushbutton

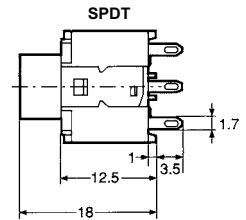
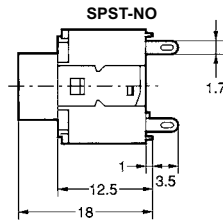
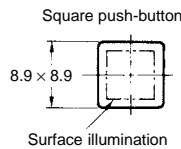
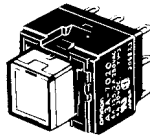

Round Pushbutton

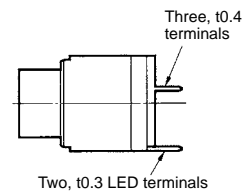
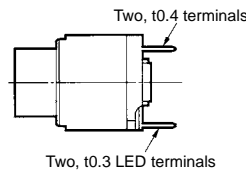
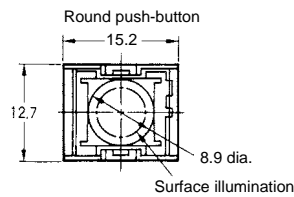
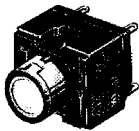

Accessories (Order Separately)

Note: Unless otherwise specified, a tolerance of ± 0.4 mm applies to all dimensions.

Leaf Spring A3A-200

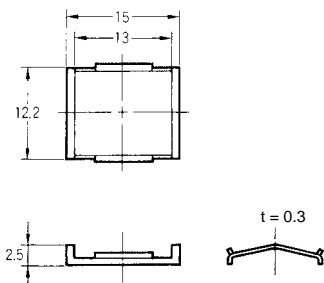

Flange (Square) A3A-24

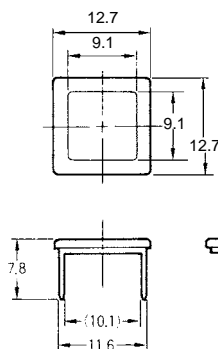

Flange (Round) A3A-25

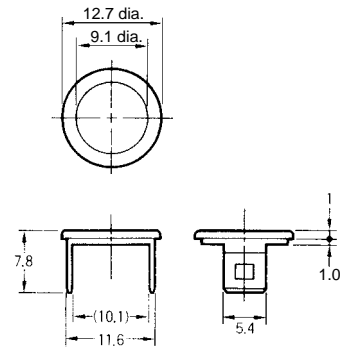

■ Panel Cutouts

Square Pushbutton

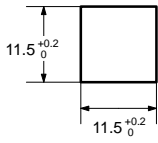

Round Pushbutton

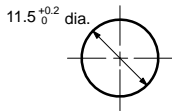

Panel Mounting Dimensions

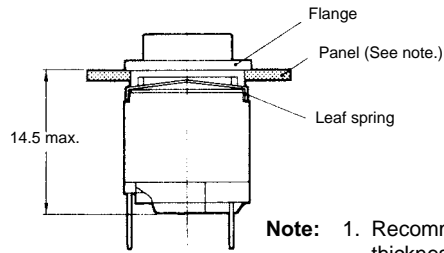

- Note:**
1. Recommended panel thickness: 1 to 1.6 mm
 2. The diagram shows the lighted SPST-NO model.

For Side-by-side Mounting

Mounting	Square pushbutton	Round pushbutton
Horizontal multiple mounting	<p>15.3 min.</p> <p>11.5^{+0.2}₀</p> <p>3.8 min.</p> <p>11.5^{+0.2}₀</p>	<p>11.5^{+0.2}₀ dia.</p> <p>15.3 min.</p>
Vertical multiple mounting	<p>11.5^{+0.2}₀</p> <p>12.7(n-1) + 11.5^{+0.3}₀</p>	<p>11.5^{+0.2}₀ dia.</p> <p>12.7 min.</p>

■ Terminals

	Solder terminal	PCB terminal	
SPST-NO	<p>Non-lighted Models</p> <p>Switch terminal: t0.4</p> <p>Lighted Models</p> <p>Switch terminal: t0.4 Lamp terminal: t0.3</p> <p>Terminal Arrangement (Bottom View)</p> <p>Terminal for models with an illuminating push-button</p>	<p>Non-lighted Models</p> <p>Switch terminal: t0.4</p> <p>Terminal Arrangement (Bottom View)</p> <p>Terminal for models with an illuminating push-button</p>	<p>Lighted Models</p> <p>Switch terminal: t0.4 Lamp terminal: t0.3</p> <p>PCB Dimensions (Bottom View)</p> <p>Holes for models with illuminating push-button</p>
	<p>Terminal Arrangement (Bottom View)</p> <p>Terminal for models with an illuminating push-button</p>	<p>Terminal Arrangement (Bottom View)</p> <p>Terminal for models with an illuminating push-button</p>	<p>PCB Dimensions (Bottom View)</p> <p>Holes for models with illuminating push-button</p>
SPDT	<p>Non-lighted Models</p> <p>Switch terminal: t0.4</p> <p>Lighted Models</p> <p>Switch terminal: t0.4 Lamp terminal: t0.3</p> <p>Terminal Arrangement (Bottom View)</p> <p>Terminal for models with an illuminating push-button</p>	<p>Non-lighted Models</p> <p>Switch terminal: t0.4</p> <p>Terminal Arrangement (Bottom View)</p> <p>Terminal for models with an illuminating push-button</p>	<p>Lighted Models</p> <p>Switch terminal: t0.4 LED terminal: t0.3</p> <p>PCB Dimensions (Bottom View)</p> <p>Holes for models with illuminating push-button</p>
	<p>Terminal Arrangement (Bottom View)</p> <p>Terminal for models with an illuminating push-button</p>	<p>Terminal Arrangement (Bottom View)</p> <p>Terminal for models with an illuminating push-button</p>	<p>PCB Dimensions (Bottom View)</p> <p>Holes for models with illuminating push-button</p>

Installation

Mounting and Replacing the Pushbutton

Mounting Direction for the Pushbutton and Switch

- Insert the catches of the Pushbutton into the grooves of the Switch and push down on the Pushbutton until it is fixed securely to the Switch.
- With lighted models, the LED is built into the Switch and cannot be replaced.

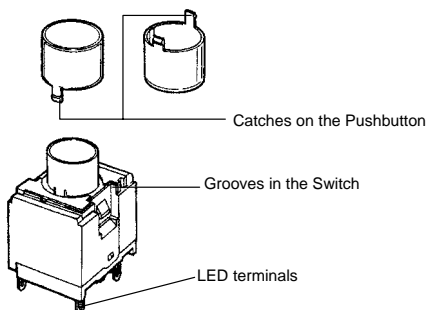

Removing the Pushbutton (Non-lighted Models Only)

- To remove the Pushbutton, hold both the Pushbutton and the Switch on the longer sides and pull the Pushbutton away from the Switch. (If the catches on the Pushbutton are bent outwards, it may result in malfunction.)

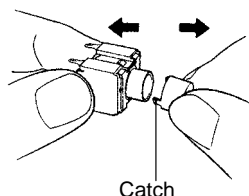

- When replacing the Pushbutton, if the cap is held on the sides with catches, internal components (e.g., plate) may come loose. Be sure to hold the Pushbutton by the sides without catches (i.e., the longer sides of the Switch) when removing.

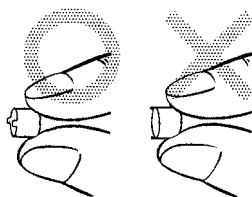

Mounting Switch on a Panel

Mount Leaf Spring

Press the leaf spring into the fitted groove on the upper surface of the Switch. For an easier fitting, first fit one side of the leaf spring, then press the other side into the fitting groove.

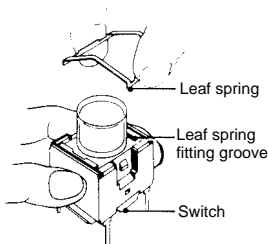

Note: Be sure to fit the leaf spring exactly into the groove, and do not allow it to slip out of the groove.

Mount Flange on Panel

Insert the flange from the front surface of the panel.

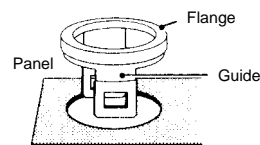

The flange has two opposing guides to facilitate its insertion into the panel cutout hole. Be sure the flange does not remain tilted with respect to the panel surface after being installed.

Cross Section

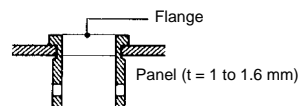

Note: The mounting direction of the flange determines the orientation of the Switch.

Fit Flange with Switch

While holding the flange, insert the opposing supports into the gaps between the leaf spring and Switch on the longer sides of the housing, and fit the rectangular hole of the flange with the projections of the switch housing.

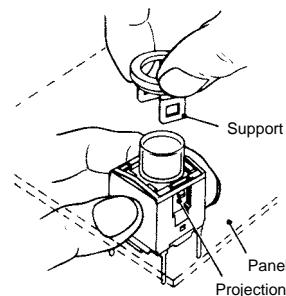

Note: Completely remove any burrs on the panel cutout surface; otherwise, the flange and Switch will not attach solidly.

Removing Switch

Insert a small flat-bladed screwdriver or tweezers into the flange support exposed on the rear of the panel. Pry up on each side to pull out the Switch.

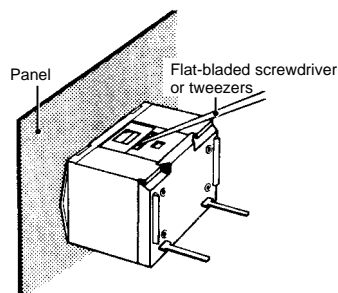

Note: Do not pry up the flange support more than necessary or the switch holding portions may be damaged.

Precautions

Operation

When operating an A3A, make sure that the A3A has a pushbutton. Do not operate the A3A with a screwdriver or tweezers without mounting a pushbutton to the A3A, otherwise the A3A may malfunction.

Mounting

When opening a hole on a panel to mount an A3A to the panel, make sure that the hole has no burr.

When mounting a flange to the switching mechanism of an A3A, make sure that the flange and the casing of the switching mechanism are engaged securely.

Wiring

When soldering the terminals of an A3A, refer to the following.

1. For manual soldering: Use a soldering iron with the terminals at a temperature of 350°C maximum within three seconds.
2. Do not impose any external force on the terminals for one minute after the terminals are soldered.

Do not pull the terminals of any A3A with a force exceeding 5.34 N, otherwise the joint part of the A3A may be damaged.

When soldering the terminals of an A3A, apply non-corrosive rosin flux to the terminals.

After soldering the terminals of an A3A, do not wash the A3A with any solvent.

When mounting an A3A to a PCB and soldering the terminals of the A3A to the PCB, make sure that the flux will not rise above the surface of the PCB.

Operating Environment

When using an A3A, make sure that dust, metal powder, or oil will not penetrate into the interior of the A3A.

LED

The polarity of the LED is indicated on the back of the Switch. Wire the LED correctly according to the polarity.

An A3A with a built-in LED does not have a limiting resistor. Connect a limiting resistor.

The resistance can be calculated by using the following expression.

$$R = (E - V_F) / I_F (\Omega)$$

E: Applied voltage (V)

V_F : LED forward voltage (V)

I_F : LED forward current (A)

Note: Make sure that the limiting resistor connected to the built-in LED of an A3A satisfies the characteristics of the built-in LED. The mean forward current of the built-in LED must be 8 mA minimum.

Example

Conditions: Red LED with an I_F of 10 mA at 24 V and a T_a of 25°C. From the red LED characteristic below, V_F will be 2 V when I_F is 10 mA. Therefore, $R = (24 V - 2 V) / 0.01 A = 2,200 \Omega$. Thus the recommended resistance is 2.2 k Ω at 0.5 W ($2^* \times I_F^2 R$).

Note: A factor of 2 (marked with an asterisk) is applied because the permissible wattage of the resistor must be twice as large as the required wattage.

LED Characteristics ($V_F - I_F$ Characteristics)

T_a : Ambient Temperature

Red

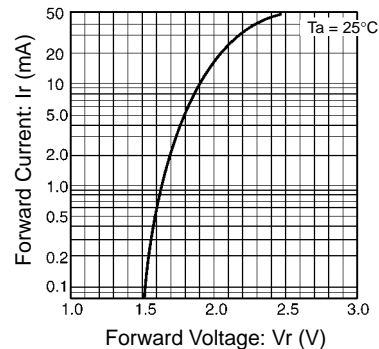

Green

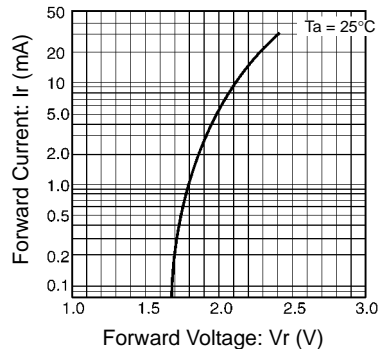

Yellow

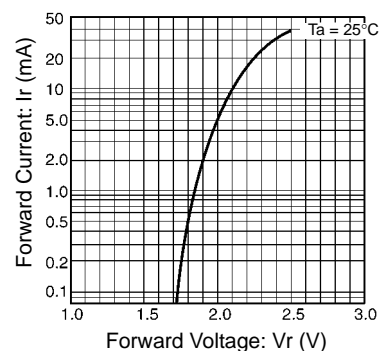

Pushbutton

When exchanging the Pushbutton (except the ones for the mechanical indicator models) with a new one, pull out the Pushbutton from the Switch, holding the Pushbutton in the longitudinal direction.

Do not remove the Pushbutton of the mechanical indicator model.

Engraving of Pushbutton

Depth of engraving:

0.3 mm max. for illuminating pushbutton

Since the Pushbutton is made of polycarbonate, use an alcohol-based solvent when cleaning the Unit.

Pressing of Pushbutton

Apply firm pressure to the Pushbutton when operating it. In doing so, however, do not apply a pressure greater than 11.8 N.

ALL DIMENSIONS SHOWN ARE IN MILLIMETERS.

To convert millimeters into inches, multiply by 0.03937. To convert grams into ounces, multiply by 0.03527.

Lighted Pushbutton Switches

A3P

Large Rectangular-bodied Lighted Pushbutton Switches

- Excellent operating sensitivity.
- Good illumination with even surface brightness.
- Three-color models (green, orange, red; chameleon lighting) included in lineup.
- UL and CSA approved.

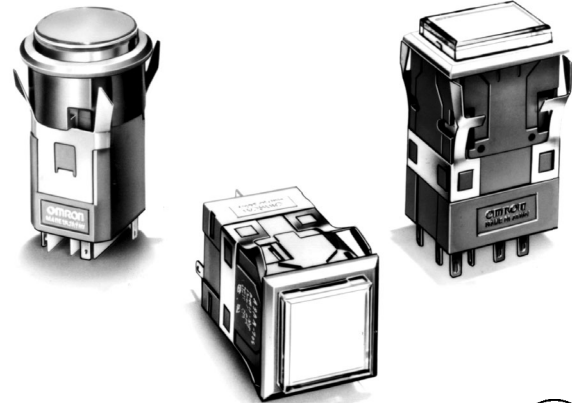

Ordering Information

■ Model Number Legend

The model numbers used to order sets of Units are illustrated below. One set comprises the Pushbutton, Lamp, and Switch.

(5) 24E (6) R - - - Single screen
 Upper Lower
(1) A 3 P (2) J - 90 (3) B (4) 1 1 - 24E RW - - - Horizontal 2-split screen
 R (Red) Upper
 W (White) Lower

(1) Shape of Pushbutton

Symbol	Shape
J	Rectangular
A	Square
T	Round

Momentary operation: Self-resetting
Alternate operation: Self-holding

(2) Switch Specifications

Standard Load

Symbol	Operation	
A	Momentary	SPDT
B	Alternate	
C	Momentary	DPDT
D	Alternate	

Microload

Symbol	Operation	
E	Momentary	SPDT
F	Alternate	
G	Momentary	DPDT
H	Alternate	

Standard Load
250 VAC, 3 A
30 VDC, 3 A

Microload
125 VAC, 0.1 A
30 VDC, 0.1 A

Minimum applicable load
5 VDC, 1 mA

3PDT models are also available.
Select from among the individual products shown on page 233.

(3) Screen Pattern

Illumination-only models

Symbol	Screen pattern
1	Single screen
2	2-split screen
G	Chameleon (see note 1, 2, 3)

Note:

- The chameleon screen pattern is not available with A3PT models.
- The chameleon screen pattern is only available with 12 or 24-VDC models.
- With chameleon models, the whole screen lights red, green, or orange. When not lit, the display is white.

The available rectangular models are shown below. Select from among the individual products shown on page 231.

Vertical 2-split screen models

4-split screen models

Horizontal 3-split screen models

Vertical 3-split screen models

The above diagrams show the Switches with the **omron** mark facing down.

(4) Case Color

Symbol	Color
1	Black
2	Light gray

Note: A3PT models are available in light gray only.

Colored-illumination models up to the 4-split screen models are available as individual Units. Refer to page 229.

"Colored-illumination" models operate in the way shown below:

Unlit

White

Lit

Color

The built-in LED is colored.

(5) Lighting Method

LED-lighted Models (A3PJ and A3PA Models Only)

Symbol	Rated voltage
05E	5 VDC
12E	12 VDC
24E	24 VDC

LED Lamp-lighted Models (A3PT Only)

Symbol	Rated voltage
05C	5 VDC
12C	12 VDC
24C	24 VDC

A3PJ and A3PA can also be ordered separately. Refer to page 231 for details.

Incandescent Lamp-lighted Models

Symbol	Rated voltage
06	6 VAC/VDC
14	14 VAC/VDC
28	28 VAC/VDC

(6) Color of Pushbutton For LED

Symbol	Color
R	Red
O	Orange
G	Green
W	White
K	Chameleon

The chameleon screen pattern is not available with A3PT models.

The chameleon screen pattern is only available with 12 or 24-VDC models.

For Incandescent Lamp

Symbol	Color
No symbol	Red, orange, white, blue, green

Includes colored plate. Refer to page 232 for details.

Number of LED Lamps

Screen pattern	A3PJ	A3PA	A3PT
Single screen	Models with built-in LED		2
Horizontal 2-split screen			2
Vertical 2-split screen	4 (See note.)	---	---
Horizontal 3-split screen		---	---
Vertical 3-split screen		---	---
4-split screen		---	---

Note: These split screen models are available only as individual Units. They cannot be ordered as sets.

■ List of Models

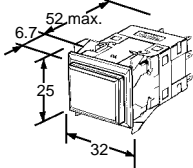
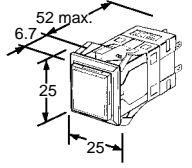
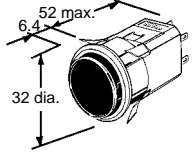
Model	A3PJ (Rectangular)	A3PA (Square)	A3PT (Round)
Appearance			

■ Construction

Lighting method	LED-lighted models (LED is built-in.)		LED lamp-lighted models (LED lamp is not built-in.)			Incandescent lamp-lighted models (Incandescent lamp is not built-in.)				
Models	A3PJ	A3PA	A3PJ	A3PA	A3PT	A3PJ	A3PA	A3PT		
Screen patterns	Single screen Horizontal 2-split screen Chameleon (3-color) 	Single screen Horizontal 2-split screen Chameleon (3-color) 	Single screen Horizontal 2-split screen Vertical 2-split screen 	Vertical 3-split screen Horizontal 3-split screen 4-split screen 	Single screen Horizontal 2-split screen 	Single screen 	Single screen Horizontal 2-split screen Vertical 2-split screen 	Vertical 3-split screen Horizontal 3-split screen 4-split screen 	Single screen Horizontal 2-split screen 	Single screen

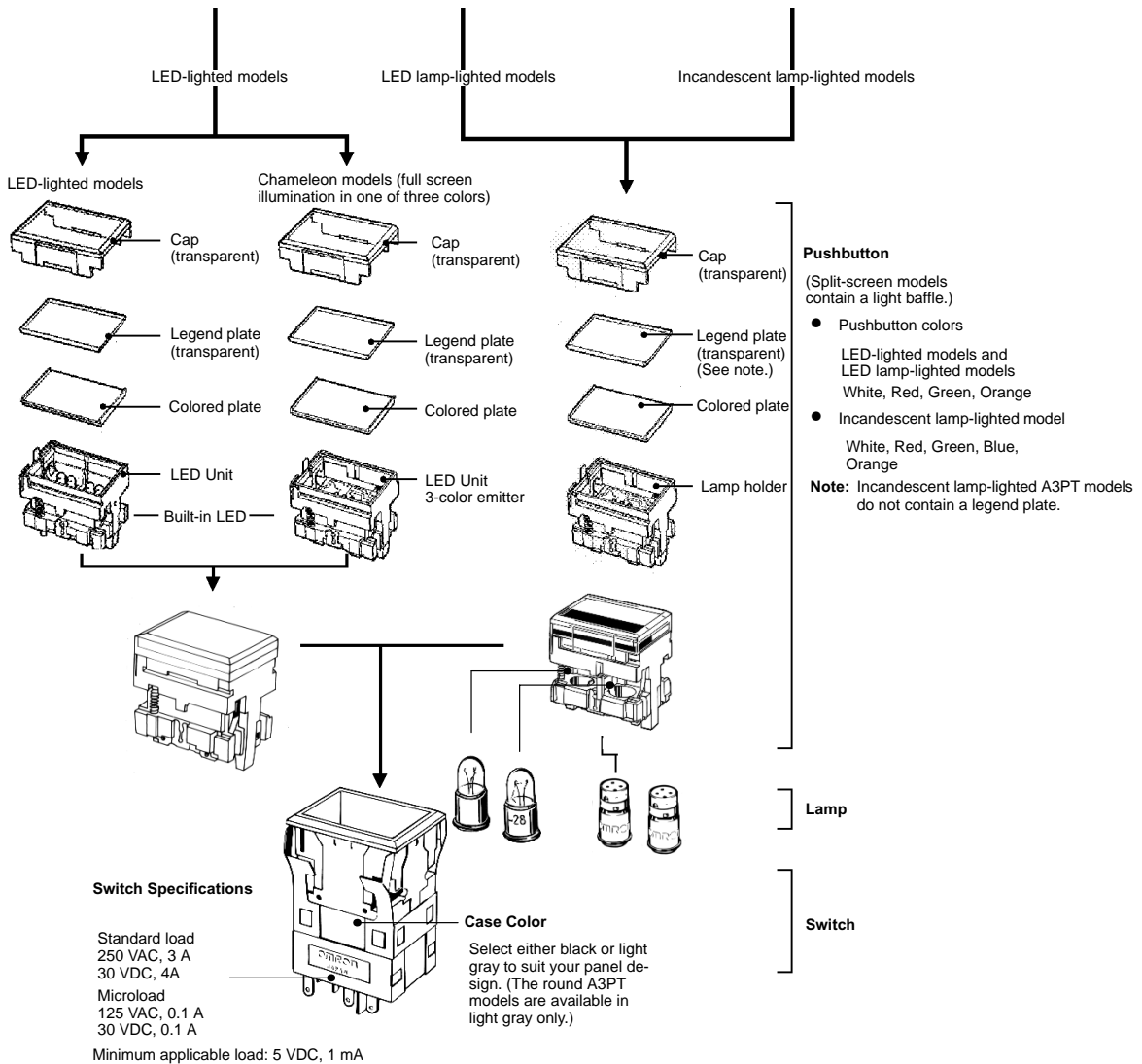

Note: The above diagram for LED lamp-lighted models and incandescent lamp-lighted models shows the A3PJ model.

■ A3P Lighting Method Diagram

The following diagram shows the Switches with the **OMRON** mark facing down.

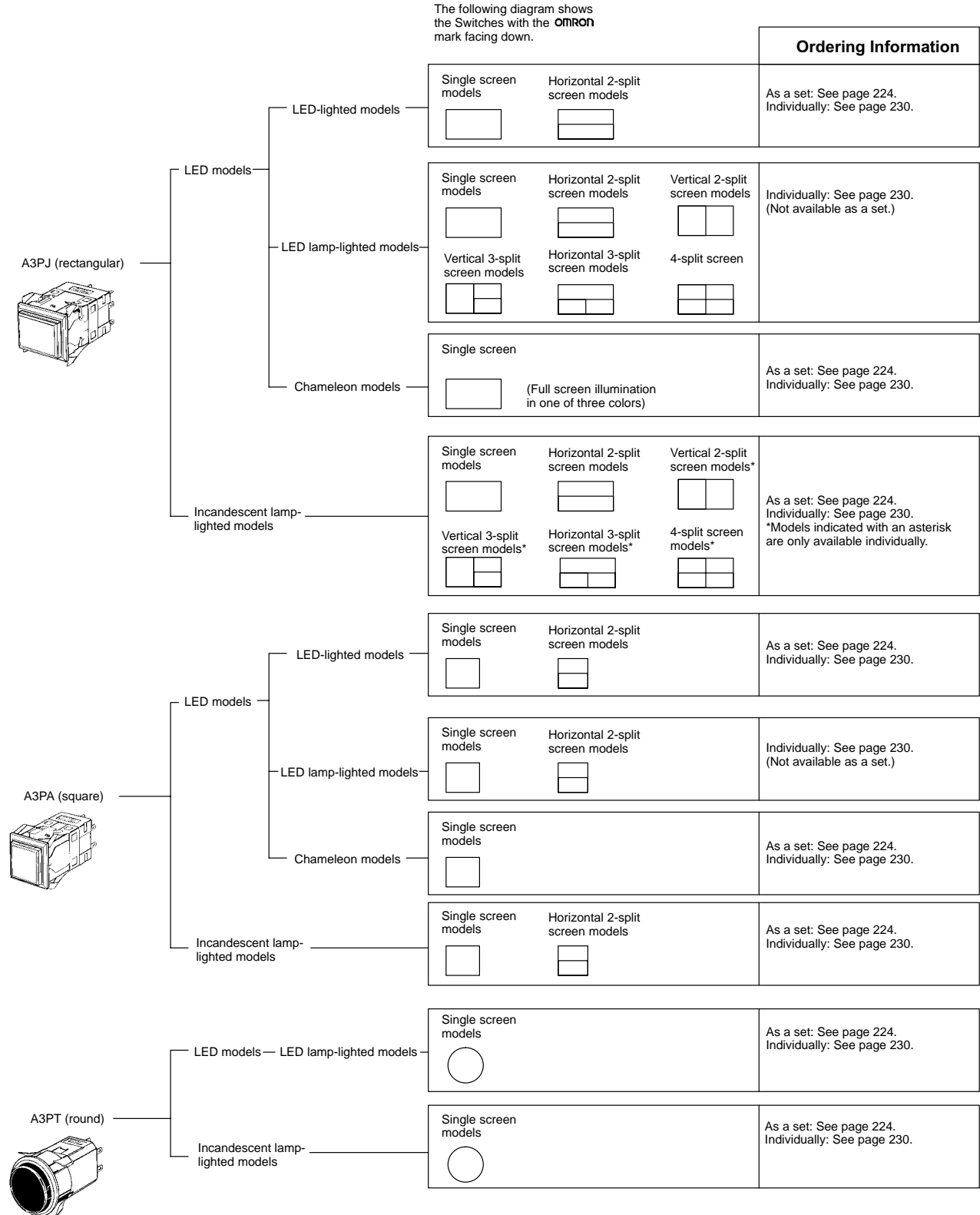

■ Ordering as a Set

The model numbers used to order sets of Units are given in the following tables. One set comprises the Pushbutton, Lamp, and Switch.

■ A3PJ (Rectangular) Single Screen Models

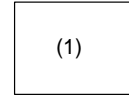
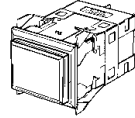

Standard Loads

Output	Lighting	Contact type Operation Case color Rated voltage	Standard load (250 VAC, 3 A; 30 VDC, 4 A)				Pushbutton color symbol
			Momentary operation (Self-resetting)		Alternate operation (Self-holding)		
			Black	Light gray	Black	Light gray	
SPDT	LED	5 VDC	A3PJ-90A11-05E(1)	A3PJ-90A12-05E(1)	A3PJ-90B11-05E(1)	A3PJ-90B12-05E(1)	R O G W
		12 VDC	A3PJ-90A11-12E(1)	A3PJ-90A12-12E(1)	A3PJ-90B11-12E(1)	A3PJ-90B12-12E(1)	
		24 VDC	A3PJ-90A11-24E(1)	A3PJ-90A12-24E(1)	A3PJ-90B11-24E(1)	A3PJ-90B12-24E(1)	
	Chameleon	12 VDC	A3PJ-90AG1-12EK	---	A3PJ-90BG1-12EK	A3PJ-90BG2-12EK	(See note 1.)
		24 VDC	A3PJ-90AG1-24EK	A3PJ-90AG2-24EK	A3PJ-90BG1-24EK	A3PJ-90BG2-24EK	
	Incandescent lamp	6 VDC/VAC	A3PJ-90A11-06	A3PJ-90A12-06	A3PJ-90B11-06	A3PJ-90B12-06	(See note 2.)
		14 VDC/VAC	A3PJ-90A11-14	A3PJ-90A12-14	A3PJ-90B11-14	A3PJ-90B12-14	
		28 VDC/VAC	A3PJ-90A11-28	A3PJ-90A12-28	A3PJ-90B11-28	A3PJ-90B12-28	
	DPDT	LED	5 VDC	A3PJ-90C11-05E(1)	A3PJ-90C12-05E(1)	A3PJ-90D11-05E(1)	A3PJ-90D12-05E(1)
12 VDC			A3PJ-90C11-12E(1)	A3PJ-90C12-12E(1)	A3PJ-90D11-12E(1)	A3PJ-90D12-12E(1)	
24 VDC			A3PJ-90C11-24E(1)	A3PJ-90C12-24E(1)	A3PJ-90D11-24E(1)	A3PJ-90D12-24E(1)	
Chameleon		12 VDC	A3PJ-90CG1-12EK	A3PJ-90CG2-12EK	A3PJ-90DG1-12EK	---	(See note 1.)
		24 VDC	A3PJ-90CG1-24EK	A3PJ-90CG2-24EK	A3PJ-90DG1-24EK	A3PJ-90DG2-24EK	
Incandescent lamp		6 VDC/VAC	A3PJ-90C11-06	A3PJ-90C12-06	A3PJ-90D11-06	A3PJ-90D12-06	(See note 2.)
		14 VDC/VAC	A3PJ-90C11-14	A3PJ-90C12-14	A3PJ-90D11-14	A3PJ-90D12-14	
		28 VDC/VAC	A3PJ-90C11-28	A3PJ-90C12-28	A3PJ-90D11-28	A3PJ-90D12-28	

Enter the desired color symbol for the Pushbutton in (1). (R) = Red, (O) = Orange, (G) = Green, (W) = White.

Example: Red A3PJ-90A11-24ER

Microloads

Output	Lighting	Contact type Operation Case color Rated voltage	Microload (125 VAC, 0.1 A; 30 VDC, 0.1 A)		Pushbutton color symbol
			Momentary operation (Self-resetting)		
			Black	Light gray	
SPDT	LED	5 VDC	A3PJ-90E11-05E(1)	A3PJ-90E12-05E(1)	R O G W
		12 VDC	A3PJ-90E11-12E(1)	A3PJ-90E12-12E(1)	
		24 VDC	A3PJ-90E11-24E(1)	A3PJ-90E12-24E(1)	
	Chameleon	12 VDC	A3PJ-90EG1-12EK	---	(See note 1.)
		24 VDC	A3PJ-90EG1-24EK	A3PJ-90EG2-24EK	
	Incandescent lamp	6 VDC/VAC	A3PJ-90E11-06	A3PJ-90E12-06	(See note 2.)
		14 VDC/VAC	A3PJ-90E11-14	A3PJ-90E12-14	
		28 VDC/VAC	A3PJ-90E11-28	A3PJ-90E12-28	
	DPDT	LED	5 VDC	A3PJ-90G11-05E(1)	A3PJ-90G12-05E(1)
12 VDC			A3PJ-90G11-12E(1)	A3PJ-90G12-12E(1)	
24 VDC			A3PJ-90G11-24E(1)	A3PJ-90G12-24E(1)	
Chameleon		12 VDC	A3PJ-90GG1-12EK	---	(See note 1.)
		24 VDC	A3PJ-90GG1-24EK	---	
Incandescent lamp		6 VDC/VAC	A3PJ-90G11-06	A3PJ-90G12-06	(See note 2.)
		14 VDC/VAC	A3PJ-90G11-14	A3PJ-90G12-14	
		28 VDC/VAC	A3PJ-90G11-28	A3PJ-90G12-28	

Enter the desired color symbol for the Pushbutton in (1). (R) = Red, (O) = Orange, (G) = Green, (W) = White.

Example: Red A3PJ-90E11-24ER

- Note:**
1. You can change the screen colors of chameleon models between red, green, and orange, by changing the terminal wiring. Refer to page 240 for details.
 2. Incandescent lamps are supplied with colored plates (white, red, green, blue, and orange) and legend plates (milk-white and transparent). Use the appropriate combination.

■ A3PJ (Rectangular) Horizontal 2-split Screen Models

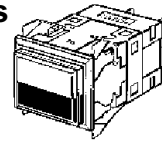

(1)
(2)

Standard Loads

Output	Lighting	Contact type Operation Case color Rated voltage	Standard load (250 VAC, 3 A; 30 VDC, 4 A)				Pushbutton color symbol		
			Momentary operation (Self-resetting)		Alternate operation (Self-holding)				
			Black	Light gray	Black	Light gray			
SPDT	LED	24 VDC	A3PJ-90A21-24E(1)(2)	A3PJ-90A22-24E(1)(2)	A3PJ-90B21-24E(1)(2)	A3PJ-90B22-24E(1)(2)	R O G W (See note)		
			Incandescent lamp	6 VDC/VAC	A3PJ-90A21-06	A3PJ-90A22-06		A3PJ-90B21-06	A3PJ-90B22-06
				14 VDC/VAC	A3PJ-90A21-14	A3PJ-90A22-14		A3PJ-90B21-14	A3PJ-90B22-14
		28 VDC/VAC	A3PJ-90A21-28	A3PJ-90A22-28	A3PJ-90B21-28	A3PJ-90B22-28			
DPDT	LED	24 VDC	A3PJ-90C21-24E(1)(2)	A3PJ-90C22-24E(1)(2)	A3PJ-90D21-24E(1)(2)	A3PJ-90D22-24E(1)(2)	R O G W (See note)		
			Incandescent lamp	6 VDC/VAC	A3PJ-90C21-06	A3PJ-90C22-06		A3PJ-90D21-06	A3PJ-90D22-06
				14 VDC/VAC	A3PJ-90C21-14	A3PJ-90C22-14		A3PJ-90D21-14	A3PJ-90D22-14
		28 VDC/VAC	A3PJ-90C21-28	A3PJ-90C22-28	A3PJ-90D21-28	A3PJ-90D22-28			

Enter the desired color symbols for the Pushbutton in (1) and (2). (R) = Red, (O) = Orange, (G) = Green, (W) = White.

Example:

Red
White

 Upper A3PJ-90A21-24E

R	W
---	---

Lower Red — White

Microloads

Output	Lighting	Contact type Operation Case color Rated voltage	Microload (125 VAC, 0.1 A; 30 VDC, 0.1 A)		Pushbutton color symbol		
			Momentary operation (Self-resetting)				
			Black	Light gray			
SPDT	LED	24 VDC	A3PJ-90E21-24E(1)(2)	A3PJ-90E22-24E(1)(2)	R O G W (See note.)		
			Incandescent lamp	6 VDC/VAC		A3PJ-90E21-06	A3PJ-90E22-06
				14 VDC/VAC		A3PJ-90E21-14	A3PJ-90E22-14
		28 VDC/VAC	A3PJ-90E21-28	A3PJ-90E22-28			
DPDT	LED	24 VDC	A3PJ-90G21-24E(1)(2)	A3PJ-90G22-24E(1)(2)	R O G W (See note.)		
			Incandescent lamp	6 VDC/VAC		A3PJ-90G21-06	A3PJ-90G22-06
				14 VDC/VAC		A3PJ-90G21-14	A3PJ-90G22-14
		28 VDC/VAC	A3PJ-90G21-28	A3PJ-90G22-28			

Enter the desired color symbols for the Pushbutton in (1) and (2). (R) = Red, (O) = Orange, (G) = Green, (W) = White.

Example:

Red
White

 Upper A3PJ-90E21-24E

R	W
---	---

Lower Red — White

Note: Incandescent lamps are supplied with colored plates (white, red, green, blue, and orange) and legend plates (milk-white and transparent). Use the appropriate combination.

■ A3PA (Square) Single Screen Models

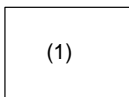
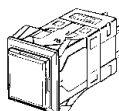

Standard Loads

Output	Lighting	Contact type Operation Case color Rated voltage	Standard load (250 VAC, 3 A; 30 VDC, 4 A)				Pushbutton color symbol
			Momentary operation (Self-resetting)		Alternate operation (Self-holding)		
			Black	Light gray	Black	Light gray	
SPDT	LED	5 VDC	A3PA-90A11-05E(1)	A3PA-90A12-05E(1)	A3PA-90B11-05E(1)	A3PA-90B12-05E(1)	R O G W
		12 VDC	A3PA-90A11-12E(1)	A3PA-90A12-12E(1)	A3PA-90B11-12E(1)	A3PA-90B12-12E(1)	
		24 VDC	A3PA-90A11-24E(1)	A3PA-90A12-24E(1)	A3PA-90B11-24E(1)	A3PA-90B12-24E(1)	
	Chameleon	12 VDC	A3PA-90AG1-12EK	A3PA-90AG2-12EK	A3PA-90BG1-12EK	A3PA-90BG2-12EK	(See note 1.)
		24 VDC	A3PA-90AG1-24EK	A3PA-90AG2-24EK	A3PA-90BG1-24EK	A3PA-90BG2-24EK	
	Incandescent lamp	6 VDC/VAC	A3PA-90A11-06	A3PA-90A12-06	A3PA-90B11-06	A3PA-90B12-06	(See note 2.)
14 VDC/VAC		A3PA-90A11-14	A3PA-90A12-14	A3PA-90B11-14	A3PA-90B12-14		
28 VDC/VAC		A3PA-90A11-28	A3PA-90A12-28	A3PA-90B11-28	A3PA-90B12-28		
DPDT	LED	5 VDC	A3PA-90C11-05E(1)	A3PA-90C12-05E(1)	A3PA-90D11-05E(1)	A3PA-90D12-05E(1)	R O G W
		12 VDC	A3PA-90C11-12E(1)	A3PA-90C12-12E(1)	A3PA-90D11-12E(1)	A3PA-90D12-12E(1)	
		24 VDC	A3PA-90C11-24E(1)	A3PA-90C12-24E(1)	A3PA-90D11-24E(1)	A3PA-90D12-24E(1)	
	Chameleon	12 VDC	A3PA-90CG1-12EK	A3PA-90CG2-12EK	A3PA-90DG1-12EK	A3PA-90DG2-12EK	(See note 1.)
		24 VDC	A3PA-90CG1-24EK	A3PA-90CG2-24EK	A3PA-90DG1-24EK	A3PA-90DG2-24EK	
	Incandescent lamp	6 VDC/VAC	A3PA-90C11-06	A3PA-90C12-06	A3PA-90D11-06	A3PA-90D12-06	(See note 2.)
		14 VDC/VAC	A3PA-90C11-14	A3PA-90C12-14	A3PA-90D11-14	A3PA-90D12-14	
		28 VDC/VAC	A3PA-90C11-28	A3PA-90C12-28	A3PA-90D11-28	A3PA-90D12-28	

Enter the desired color symbol for the Pushbutton in (*). (R) = Red, (O) = Orange, (G) = Green, (W) = White.

Example: Red A3PA-90A11-24ER

Microloads

Output	Lighting	Contact type Operation Case color Rated voltage	Microload (125 VAC, 0.1 A; 30 VDC, 0.1 A)		Pushbutton color symbol
			Momentary operation (Self-resetting)		
			Black	Light gray	
SPDT	LED	5 VDC	A3PA-90E11-05E(1)	A3PA-90E12-05E(1)	R O G W
		12 VDC	A3PA-90E11-12E(1)	A3PA-90E12-12E(1)	
		24 VDC	A3PA-90E11-24E(1)	A3PA-90E12-24E(1)	
	Chameleon	12 VDC	A3PA-90EG1-12EK	---	(See note 1.)
		24 VDC	A3PA-90EG1-24EK	A3PA-90EG2-24EK	
	Incandescent lamp	6 VDC/VAC	A3PA-90E11-06	A3PA-90E12-06	(See note 2.)
14 VDC/VAC		A3PA-90E11-14	A3PA-90E12-14		
28 VDC/VAC		A3PA-90E11-28	A3PA-90E12-28		
DPDT	LED	5 VDC	A3PA-90G11-05E(1)	A3PA-90G12-05E(1)	R O G W
		12 VDC	A3PA-90G11-12E(1)	A3PA-90G12-12E(1)	
		24 VDC	A3PA-90G11-24E(1)	A3PA-90G12-24E(1)	
	Chameleon	12 VDC	A3PA-90GG1-12EK	---	(See note 1.)
		24 VDC	A3PA-90GG1-24EK	---	
	Incandescent lamp	6 VDC/VAC	A3PA-90G11-06	A3PA-90G12-06	(See note 2.)
		14 VDC/VAC	A3PA-90G11-14	A3PA-90G12-14	
		28 VDC/VAC	A3PA-90G11-28	A3PA-90G12-28	

Enter the desired color symbol for the Pushbutton in (1). (R) = Red, (O) = Orange, (G) = Green, (W) = White.

Example: Red A3PA-90E11-24ER

- Note:**
1. You can change the screen colors of chameleon models between red, green, and orange, by changing the terminal wiring. Refer to page 240 for details.
 2. Incandescent lamps are supplied with colored plates (white, red, green, blue, and orange) and legend plates (milk-white and transparent). Use the appropriate combination.

■ A3PA (Square) Horizontal 2-split Screen Models

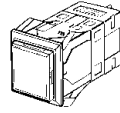

(1)
(2)

Standard Loads

Output	Lighting	Contact type Operation Case color Rated voltage	Standard load (250 VAC, 3 A; 30 VDC, 4 A)				Push-button color symbol
			Momentary operation (Self-resetting)		Alternate operation (Self-holding)		
			Black	Light gray	Black	Light gray	
SPDT	LED	24 VDC	A3PA-90A21-24E(1)(2)	A3PA-90A22-24E(1)(2)	A3PA-90B21-24E(1)(2)	A3PA-90B22-24E(1)(2)	R O G W
	Incandescent lamp	6 VDC/VAC	A3PA-90A21-06	A3PA-90A22-06	A3PA-90B21-06	A3PA-90B22-06	(See note.)
		14 VDC/VAC	A3PA-90A21-14	A3PA-90A22-14	A3PA-90B21-14	A3PA-90B22-14	
28 VDC/VAC	A3PA-90A21-28	A3PA-90A22-28	A3PA-90B21-28	A3PA-90B22-28			
DPDT	LED	24 VDC	A3PA-90C21-24E(1)(2)	A3PA-90C22-24E(1)(2)	A3PA-90D21-24E(1)(2)	A3PA-90D22-24E(1)(2)	R O G W
	Incandescent lamp	6 VDC/VAC	A3PA-90C21-06	A3PA-90C22-06	A3PA-90D21-06	A3PA-90D22-06	(See note.)
		14 VDC/VAC	A3PA-90C21-14	A3PA-90C22-14	A3PA-90D21-14	A3PA-90D22-14	
28 VDC/VAC	A3PA-90C21-28	A3PA-90C22-28	A3PA-90D21-28	A3PA-90D22-28			

Enter the desired color symbols for the Pushbutton in (1) and (2). (R) = Red, (O) = Orange, (G) = Green, (W) = White.

Example:

Red
White

 Upper A3PA-90A21-24E

R	W
---	---

Lower Red — White

Microloads

Output	Lighting	Contact type Operation Case color Rated voltage	Microload (125 VAC, 0.1 A; 30 VDC, 0.1 A)		Push-button color symbol
			Momentary operation (Self-resetting)		
			Black	Light gray	
SPDT	LED	24 VDC	A3PA-90E21-24E(1)(2)	A3PA-90E22-24E(1)(2)	R O G W
	Incandescent lamp	6 VDC/VAC	A3PA-90E21-06	A3PA-90E22-06	(See note.)
		14 VDC/VAC	A3PA-90E21-14	A3PA-90E22-14	
28 VDC/VAC	A3PA-90E21-28	A3PA-90E22-28	A3PA-90E22-28		
DPDT	LED	24 VDC	A3PA-90G21-24E(1)(2)	A3PA-90G22-24E(1)(2)	R O G W
	Incandescent lamp	6 VDC/VAC	A3PA-90G21-06	A3PA-90G22-06	(See note.)
		14 VDC/VAC	A3PA-90G21-14	A3PA-90G22-14	
28 VDC/VAC	A3PA-90G21-28	A3PA-90G22-28	A3PA-90G22-28		

Enter the desired color symbols for the Pushbutton in (1) and (2). (R) = Red, (O) = Orange, (G) = Green, (W) = White.

Example:

Red
White

 Upper A3PA-90E21-24E

R	W
---	---

Lower Red — White

Note: Incandescent lamps are supplied with colored plates (white, red, green, blue, and orange) and legend plates (milk-white and transparent). Use the appropriate combination.

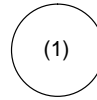

■ A3PT (Round) Single Screen Models



Standard Loads

Output	Lighting	Contact type Operation Case color Rated voltage	Standard load (250 VAC, 3 A; 30 VDC, 4 A)		Pushbutton color symbol
			Momentary operation (Self-resetting)	Alternate operation (Self-holding)	
			Light gray	Light gray	
SPDT	LED	24 VDC	A3PT-90A12-24C(1)	A3PT-90B12-24C(1)	R O G W
	Incandescent lamp	6 VDC/VAC	A3PT-90A12-06	A3PT-90B12-06	(See note.)
		14 VDC/VAC	A3PT-90A12-14	A3PT-90B12-14	
		28 VDC/VAC	A3PT-90A12-28	A3PT-90B12-28	
DPDT	LED	24 VDC	A3PT-90C12-24C(1)	A3PT-90D12-24C(1)	R O G W
	Incandescent lamp	6 VDC/VAC	A3PT-90C12-06	A3PT-90D12-06	(See note.)
		14 VDC/VAC	A3PT-90C12-14	A3PT-90D12-14	
		28 VDC/VAC	A3PT-90C12-28	A3PT-90D12-28	



Enter the desired color symbols for the Pushbutton in (1) and (2). (R) = Red, (O) = Orange, (G) = Green, (W) = White.

Example:  A3PT-90A12-24C 

Microloads

Output	Lighting	Contact type Operation Case color Rated voltage	Microload (125 VAC, 0.1 A; 30 VDC, 0.1 A)	Pushbutton color symbol
			Momentary operation (Self-resetting)	
			Light gray	
SPDT	LED	24 VDC	A3PT-90E12-24C(1)	R O G W
	Incandescent lamp	28 VDC/VAC	A3PT-90E12-28	(See note.)
DPDT	LED	24 VDC	A3PT-90G12-24C(1)	R O G W
	Incandescent lamp	28 VDC/VAC	A3PT-90G12-28	(See note.)

Enter the desired color symbols for the Pushbutton in (1). (R) = Red, (O) = Orange, (G) = Green, (W) = White.

Example:  A3PT-90E12-24C 

Note: Incandescent lamps are supplied with a colored plates (white, red, green, blue, and orange). Use the appropriate combination. Models A3PT (round models), however, are not supplied with legend plates.

■ Illumination-only and Colored-illumination LED Models

- “Illumination only” describes LED models for which the screen color is the same whether the LED is lit or not. The screen simply becomes brighter when the LED lights.

Example: Red LED

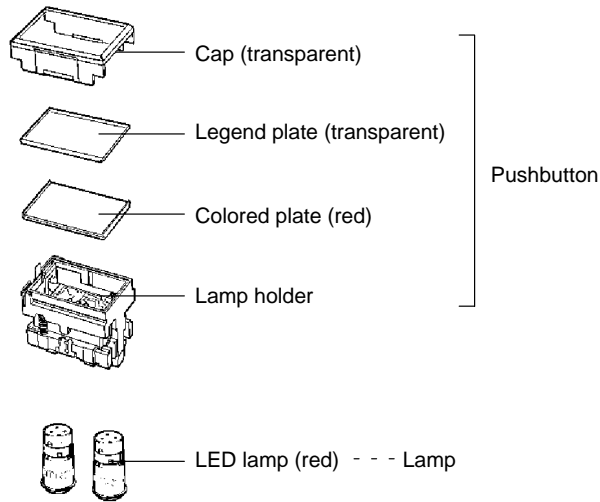
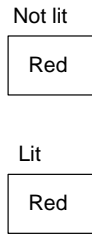

- “Colored illumination” describes LED models for which the screen color is white when the LED is not lit and changes to the color of the LED lamp when the LED is lit.

Example: Red LED

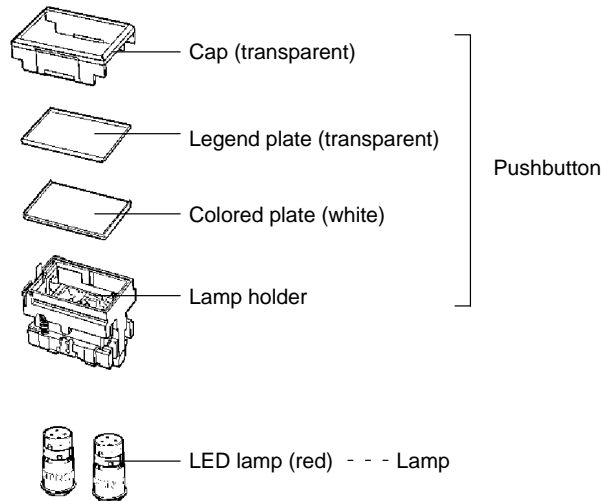
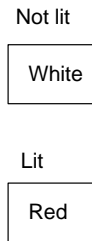

Ordering: With colored-illumination models, order the Pushbutton, Lamp, and Switch as shown in the following table.

Pushbutton	Lamp	Switch
Select the LED lamp-lighted model required from the selection on page 231. Each assembly includes the number of white colored plates required to enable colored illumination for the corresponding screen-split configuration. For example, 4-split screen models include 4 white colored plates.	Select the LED lamps to suit your desired coloration from the selection on page 232. Number of necessary LED lamps (standard) A3PJ (rectangular): 4 A3PA (square): 2 A3PT (round): 2	Select from the Switches on page 233.

■ Ordering Individually

Pushbuttons, Lamps, and Switches can be ordered separately. Combinations that are not available as sets can be created using individual Units. Also, store the parts as spares for maintenance and repairs.

LED-lighted/Chameleon Models
(LED is built into the Pushbutton.)

LED Lamp-lighted Models
(LED lamp and Pushbutton are separate.)

Incandescent Lamp-lighted Models
(Incandescent lamp and Pushbutton are separate.)

Pushbutton
Round (A3PT) models not available.

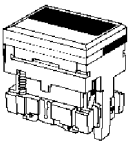

A3P□-5□□□-□□E
(for Pushbutton Switch)

Pushbutton

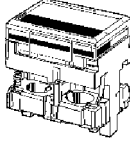

A3P□-502□
(for Pushbutton Switch)

Pushbutton

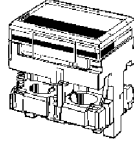

A3P□-501□
(for Pushbutton Switch)

Lamp (LED Lamp)
(See note 2.)



SLL-□□E□

Lamp (Incandescent Lamp)
(See note 3.)



Standard lamp: SLL-□□
Low-power lamp: SLL-□□H

Switch (See note 1.)
Round (A3PT) models not available.

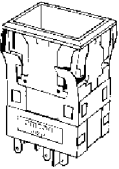

A3P□-7□□□-□
(for Pushbutton Switch)

Switch (See note 1.)

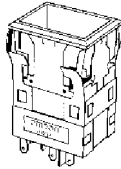

A3P□-7□□□-□
(for Pushbutton Switch)

Switch (See note 1.)

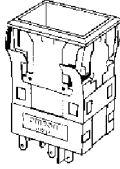

A3P□-7□□□-□
(for Pushbutton Switch)











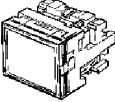



- Note:** 1. The Switch is compatible with LED-lighted models, LED lamp-lighted models, and incandescent lamp-lighted models.
2. Number of necessary LED lamps.
3. Number of necessary incandescent lamps.

Screen pattern	A3PJ	A3PA	A3PT
Single screen	4	2	2
Horizontal 2-split screen		2	2
Vertical 2-split screen		---	---
Vertical 3-split screen		---	---
Horizontal 3-split screen		---	---
4-split screen		---	---

Screen pattern	A3PJ	A3PA	A3PT
Single screen	2	1	2
Horizontal 2-split screen	4 (low-power incandescent lamp)	2	2
Vertical 2-split screen		---	---
Vertical 3-split screen		---	---
Horizontal 3-split screen		---	---
4-split screen		---	---
		---	---











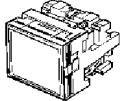

Pushbutton

LED-lighted Models (LED is built-in.)

Model	Split-screen color (color symbol)	White (W)	Red (R)	Green (G)	Orange (O)	Selection precautions	
Rectangular models 	Single screen		A3PJ-5701-□□E	A3PJ-5702-□□E	A3PJ-5703-□□E	A3PJ-5706-□□E	Enter the voltage to be used in the □□ at the end of the model number. Examples of voltages used: 5 V =  E 12 V =  E 24 V =  E For the color of the shaded part, select the model according to the colors given at the top of the table.
	Horizontal 2-split screen		A3PJ-5711-□□E	A3PJ-5712-□□E	A3PJ-5713-□□E	A3PJ-5716-□□E	
			A3PJ-5721-□□E	A3PJ-5722-□□E	A3PJ-5723-□□E	A3PJ-5726-□□E	
			A3PJ-5731-□□E	A3PJ-5732-□□E	A3PJ-5733-□□E	A3PJ-5736-□□E	
			A3PJ-5741-□□E	A3PJ-5742-□□E	A3PJ-5743-□□E	A3PJ-5746-□□E	
Square models 	Single screen		A3PA-5701-□□E	A3PA-5702-□□E	A3PA-5703-□□E	A3PA-5706-□□E	
	Horizontal 2-split screen		A3PA-5711-□□E	A3PA-5712-□□E	A3PA-5713-□□E	A3PA-5716-□□E	
			A3PA-5721-□□E	A3PA-5722-□□E	A3PA-5723-□□E	A3PA-5726-□□E	
			A3PA-5731-□□E	A3PA-5732-□□E	A3PA-5733-□□E	A3PA-5736-□□E	
			A3PA-5741-□□E	A3PA-5742-□□E	A3PA-5743-□□E	A3PA-5746-□□E	

- Note:**
1. A cap, legend plate (transparent), colored plate, white plunger case, and LED (with a current-limiting resistor) are built into the standard lighting unit.
 2. Split-screen coloring configurations are given with the **OMRON** mark on the Switch facing down.
 3. The LED is built-in and cannot be replaced individually.









LED Lamp-lighted Models (LED is not built-in.)

Model	Rectangular models 		Square models 		Round models 	
Screen pattern	Screen	Model	Screen	Model	Screen	Model
Single screen		A3PJ-5021		A3PA-5021		A3PT-5021
Horizontal 2-split screen		A3PJ-5022		A3PA-5022	---	---
Vertical 2-split screen		A3PJ-5023	---	---	---	---
Horizontal 3-split screen		A3PJ-5024	---	---	---	---
Vertical 3-split screen		A3PJ-5025	---	---	---	---
4-split screen		A3PJ-5026	---	---	---	---

- Note:**
1. Colored plates (white, red, green, and orange), a legend plate (transparent), and a light baffle (split-screen models only) are included. Use the appropriate combination for the LED coloring required.
 2. The number of white colored plates required to enable colored illumination for the corresponding screen-split configuration is included. (For example, 4-split screen models include 4 white colored plates). The number of colored plates included for each model are shown in the following table.

Screen pattern	White	Red	Green	Orange
Single screen	1	1	1	1
Horizontal 2-split screens Vertical 2-split screens	2	1	1	1
Horizontal 3-split screens Vertical 3-split screens	3	2	2	2
4-split screen	4	1	1	1



Incandescent Lamp-lighted Models (Incandescent lamp is not built-in.)

Model	Rectangular models		Square models		Round models	
	Screen	Model	Screen	Model	Screen	Model
Single screen		A3PJ-5011		A3PA-5011		A3PT-5011
Horizontal 2-split screen		A3PJ-5012		A3PA-5012	---	---
Vertical 2-split screen		A3PJ-5013	---	---	---	---
Horizontal 3-split screen		A3PJ-5014	---	---	---	---
Vertical 3-split screen		A3PJ-5015	---	---	---	---
4-split screen		A3PJ-5016	---	---	---	---

- Note:**
1. Colored plates (white, red, green, orange, and blue), a legend plate (transparent), and a light baffle (split-screen models only) are supplied.
 2. A3PT (round) models do not contain a legend plate.
 3. The number of colored plates included is shown in the following table.

Screen pattern	White	Red	Green	Orange	Blue
Single screen	1	1	1	1	1
Horizontal and vertical 2-split screens	1	1	1	1	1
Horizontal and vertical 3-split screens	2	2	2	2	2
4-split screen	2	2	2	2	2

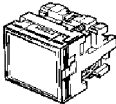
Chameleon Models (with Built-in LED)

Shape	Rated voltage	Chameleon pushbutton switch
 Rectangular	12 VDC	A3PJ-5800-12E
	24 VDC	A3PJ-5800-24E
 Square	12 VDC	A3PA-5800-12E
	24 VDC	A3PA-5800-24E

- Note:**
1. With chameleon models the whole screen lights red, green, or orange (i.e., red and green simultaneously).
 2. A cap, legend plate (transparent), white colored plate, and LED (with a current-limiting resistor) are built into the Pushbutton.

Lamp (For details on mounting, refer to page 246.)

LED Lamp

Voltage	5 VDC	12 VDC	24 VDC	Applicable cap (color) (colored plate)	Selection precautions
	Model (DC only)	Model (DC only)	Model (DC only)		
Red	SLL-05ER	SLL-12ER	SLL-24ER	Red	In the standard setup, 4 LED lamps are used with A3PJ models and 2 LED lamps are used with A3PA and A3PT models.
Yellow	SLL-05EY	SLL-12EY	SLL-24EY	Orange	
Green	SLL-05EG	SLL-12EG	SLL-24EG	Green	
White	SLL-05EW	SLL-12EW	SLL-24EW	White	







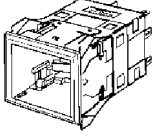
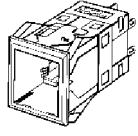
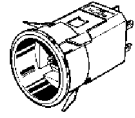

Incandescent Lamp

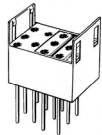
Lamp type	Standard lamp	Low-voltage lamp	Selection precautions
Voltage			
5 VAC/VDC	SLL-06	SLL-06H	In the standard setup for A3PJ models, 2 lamps are used with single screen models, and 4 lamps are used with split-screen models. If 3 or 4 lamps are lit continuously, use low-power lamps. In the standard setup for A3PA models, 1 lamp is used with single screen models, and 2 lamps are used with split-screen models. In the standard setup for A3PT models, 2 lamps are used.
12 VAC/VDC	SLL-14	SLL-14H	
24 VAC/VDC	SLL-28	SLL-28H	

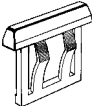

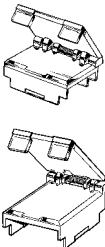

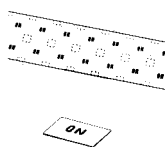





Switch (common to both incandescent lamp-lighted models and LED models)



Contact type	Switch	Number of outputs	Operation	Rectangular models 	Square models 	Round models 	Selection precautions
Standard load	Silver alloy contact	1	Momentary operation	A3PJ-7010-1	A3PA-7010-1	A3PT-7010-2	The end digit denotes the color of the flange: -1 denotes a black flange, and -2 denotes a light gray flange. Round switches are available only in light gray, and not in black. Use the Switch in combination with the same shape Lamp (rectangular, square, or round). Example: For rectangular Lamp A3PJ-5011, select Switch A3PJ-7□□0-□. On the Switch itself, however, only 3 digits are shown, as follows: A3PJ-7□□.
			Alternate operation	A3PJ-7020-1	A3PA-7020-1	A3PT-7020-2	
		2	Momentary operation	A3PJ-7030-1	A3PA-7030-1	A3PT-7030-2	
			Alternate operation	A3PJ-7040-1	A3PA-7040-1	A3PT-7040-2	
		3	Momentary operation	A3PJ-7150-1	---	---	
			Alternate operation	A3PJ-7160-1	---	---	
Microload	Gold alloy contact	1	Momentary operation	A3PJ-7050-1	A3PA-7050-1	A3PT-7050-2	
			Alternate operation	A3PJ-7060-1	A3PA-7060-1	A3PT-7060-2	
		2	Momentary operation	A3PJ-7070-1	A3PA-7070-1	A3PT-7070-2	
			Alternate operation	A3PJ-7080-1	A3PA-7080-1	A3PT-7080-2	
		3	Momentary operation	A3PJ-7170-1	---	---	
			Alternate operation	A3PJ-7180-1	---	---	

■ Accessories

Name	Appearance	Classification		Rectangular	Square	Application precautions		
Socket		Wire-wrap terminal		A3PJ-4101	A3PA-4101	Multiple sockets cannot be mounted.		
		PCB terminal		A3PJ-4102	A3PA-4102			
		Solder terminal		A3PJ-4103	A3PA-4103			
Barrier		Short edge barrier (Horizontal mounting) (1 pair)	Black	A3PJ-4001	A3PA-4001	The purpose of the barrier is to prevent malfunctioning and to improve design image of the mounting panel. Intermediate barrier x 1. Edge barriers x 1 pair (2 Units). Mount short barriers horizontally. Mount long barriers vertically. For details on mounting, refer to page 246.		
			Light gray	A3PJ-4002	A3PA-4002			
		Long edge barrier (Vertical mounting) (1 pair)	Black	A3PJ-4004	---			
			Light gray	A3PJ-4005	---			
		Short intermediate barrier (Horizontal mounting)	Black	A3PJ-4007	A3PA-4007			
			Light gray	A3PJ-4008	A3PA-4008			
		Long intermediate barrier (Vertical mounting)	Black	A3PJ-4010	---			
			Light gray	A3PJ-4011	---			
	Switch guard		For horizontal mounting (with OMRON logo facing down)		A3PJN-5050		A3PAN-5050	Can be used by exchanging with the cap. Cannot be used with seal cover. Can be used with barrier. Use horizontal mounting guard for consecutive horizontal mounting, and use vertical mounting guard for consecutive vertical mounting.
			For vertical mounting (with OMRON logo facing to the right)		A3PJN-5055		A3PAN-5055	
Seal cover		---		A3PJ-5060	A3PA-5060	Cannot be used with barrier and/or switch guard. For details on mounting, refer to page 246. Cap is manufactured from vinyl chloride.		
Character plate (character film)		1 sheet (for 20 Switches)	Printed	A3PJ-5205	A3PA-5205	Words printed are ON, OFF, START, STOP, RESET, OK, OUT, POWER, COOL, and MOTOR. Other characters can be printed by request.		
			Non-printed (transparent film)	A3PJ-5207	A3PA-5207			
		1 sheet (for 1 Switch)	Printed	A3PJ-5206	A3PA-5206			
			Non-printed (transparent film)	A3PJ-5208	A3PA-5208			
Long mounting plate		---		A3PJ-3002	---	Use when vertically mounting individual (with barrier) or multiple Switches (in standard mounting style and with barrier). Since a short mounting plate is attached to the Switch, replace it with the long one.		

Parts

Name	Appearance	Screen pattern and color	Rectangular	Square	Application precautions	
Colored plate for incandescent lamp		Single screen 	White	A3PJ-5101	A3PA-5101	Keep mounted at all times. If the colored plate becomes discolored, contact OMRON. For details on mounting, refer to page 246.
			Red	A3PJ-5102	A3PA-5102	
			Green	A3PJ-5103	A3PA-5103	
			Blue	A3PJ-5104	A3PA-5104	
			Yellow	A3PJ-5105	A3PA-5105	
			Orange	A3PJ-5106	A3PA-5106	
		Horizontal 2-split screen 	White	A3PJ-5121	A3PA-5121	
			Red	A3PJ-5122	A3PA-5122	
			Green	A3PJ-5123	A3PA-5123	
			Blue	A3PJ-5124	A3PA-5124	
			Yellow	A3PJ-5125	A3PA-5125	
			Orange	A3PJ-5126	A3PA-5126	
		Vertical 2-split screen 	White	A3PJ-5131	---	
			Red	A3PJ-5132	---	
			Green	A3PJ-5133	---	
			Blue	A3PJ-5134	---	
			Yellow	A3PJ-5135	---	
			Orange	A3PJ-5136	---	
		4-split screen 	White	A3PJ-5161	---	
			Red	A3PJ-5162	---	
Green	A3PJ-5163		---			
Blue	A3PJ-5164		---			
Yellow	A3PJ-5165		---			
Orange	A3PJ-5166		---			
Colored plate for LED		Single screen 	White	A3PJ-5301	A3PA-5301	Keep mounted at all times. If the colored plate is lost or damaged, contact OMRON. Use in accordance with coloring of the built-in LED. For details on mounting, refer to page 246.
			Red	A3PJ-5302	A3PA-5302	
			Green	A3PJ-5303	A3PA-5303	
			Yellow	A3PJ-5305	A3PA-5305	
			Orange	A3PJ-5306	A3PA-5306	
			Horizontal 2-split screen 	White	A3PJ-5321	
		Red		A3PJ-5322	A3PA-5322	
		Green		A3PJ-5323	A3PA-5323	
		Yellow		A3PJ-5325	A3PA-5325	
		Orange		A3PJ-5326	A3PA-5326	
		Vertical 2-split screen 		White	A3PJ-5331	
			Red	A3PJ-5332	---	
			Green	A3PJ-5333	---	
			Yellow	A3PJ-5335	---	
			Orange	A3PJ-5336	---	
			4-split screen 	White	A3PJ-5361	
		Red		A3PJ-5362	---	
		Green		A3PJ-5363	---	
		Yellow		A3PJ-5365	---	
		Orange		A3PJ-5366	---	
Light baffle		Horizontal 2-split screen		A3PJ-4302	A3PA-4302	Keep mounted at all times. If the light baffle is lost, contact OMRON. Used in LED lamp-lighted models. Cannot be used in LED-lighted models.
		Vertical 2-split screen		A3PJ-4303	---	
		Horizontal 3-split screen	Long axis	A3PJ-4304	---	
			Short axis	A3PJ-4305	---	
		Vertical 3-split screen	Long axis	A3PJ-4306	---	
			Short axis	A3PJ-4307	---	
		4-split screen	Long axis	A3PJ-4304	---	
			Short axis	A3PJ-4308	---	

Name	Appearance	Screen pattern and color	Rectangular	Square	Application precautions
Legend plate		Transparent legend plate	A3PJ-5202	A3PA-5202	A transparent legend plate is mounted on the Pushbutton.
		Milk-white legend plate	A3PJ-5201	A3PA-5201	
Cap		Transparent cap	A3PJ-5600	A3PA-5600	---
		Crimp-processed transparent cap	A3PJ-5600-A	A3PA-5600-A	The surface is crimp-processed, so there is no reflection.
		Smokey-blue transparent cap	A3PJ-5600-SB	A3PA-5600-SB	You can easily tell if the button is lit, even in bright locations.

Tools

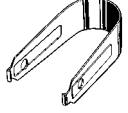
Name	Appearance	Classification	Model	Application precautions
Extractor		---	A3PJ-5080	Use to extract components when replacing the Pushbutton.

Specifications

■ Ratings

Contact Ratings

Silver Alloy Contacts (for Standard Loads)

Rated voltage (V)	Non-inductive load (A)				Inductive load (A)			
	Resistive load		Lamp load		Inductive load		Motor load	
	NC	NO	NC	NO	NC	NO	NC	NO
125 VAC	5		0.7		3		1.3	
250 VAC	3		0.5		2		0.8	
8 VDC	5		2		4		3	
14 VDC	5		2		4		3	
30 VDC	4		2		3		3	
125 VDC	0.4		0.05		0.4		0.05	
250 VDC	0.2		0.03		0.2		0.03	

- Note:**
- The above values are for steady-state currents.
 - Inductive load: Power factor = 0.4; time constant = 7 ms.
 - The lamp load has an inrush current of 10 times the steady-state current.
 - The motor load has an inrush current of 6 times the steady-state current.
The above ratings conform to JIS C4505, for testing under the following conditions.
 - (1) Ambient temperature: $20 \pm 2^{\circ}\text{C}$.
 - (2) Ambient humidity: $65 \pm 5\%$
 - (3) Operating frequency: 20 times/min.

Gold Alloy Contacts (for Microloads)

Rated voltage (V)	0.1 A at 30 VDC (resistive load); 0.1 A at 125 VAC (resistive load)
Minimum applicable load	1 mA at 5 VDC

■ LED and Incandescent Lamp Ratings

LED for LED-lighted Models

Model		A3PJ/M2PJ				A3PA/M2PA	
		Rated current					
Applicable voltage	Rated voltage	Single screen	2-split screen	3-split screen	4-split screen	Single screen	2-split screen
5 VDC $\pm 5\%$	5 VDC	80 mA	40 mA x 2	20 mA x 2	20 mA x 4	80 mA	40 mA x 2
12 VDC $\pm 5\%$	12 VDC	40 mA	20 mA x 2	15 mA x 2	15 mA x 4	40 mA	20 mA x 2
24 VDC $\pm 5\%$	24 VDC	20 mA	15 mA x 2	15 mA x 2	15 mA x 2	20 mA	13 mA x 2

LED for Chameleon Models

Applied voltage	Rated voltage	Rated current	
		Green	Red
12 VDC $\pm 5\%$	12 VDC	26 mA	20 mA
24 VDC $\pm 5\%$	24 VDC	13 mA	10 mA

Incandescent Lamp

Item		Standard lamp		Low-power lamp	
Applied voltage	Rated voltage	Rated current	Model	Rated current	Model
5 VDC	6 V	200 mA	SLL-06	100 mA	SLL-06H
12 VDC	14 V	80 mA	SLL-14	40 mA	SLL-14H
24 VDC	28 V	40 mA	SLL-28	25 mA	SLL-28H

LED Lamp (for LED Lamp-lighted Models)

Applied voltage	Rated voltage	Rated current	Model
5 VDC $\pm 5\%$	5 VDC	30 mA	SLL-05E□
12 VDC $\pm 5\%$	12 VDC	15 mA	SLL-12E□
24 VDC $\pm 5\%$	24 VDC	12.5 mA	SLL-24E□

Note: Only DC LED lamps are available.

■ Characteristics

Operating frequency	Mechanical: 120 operations/minute max. (See note 1.) Electrical: 30 operations/minute max.
Insulation resistance	100 MΩ min. (at 500 VDC)
Dielectric strength	1,000 VAC, 50/60 Hz for 1 minute between terminals of same polarity (See note 2.)
	2,000 VAC, 50/60 Hz for 1 minute between terminals of different polarity, between current-carrying metal part and ground, and between each terminal and non-current-carrying metal part.
	1,000 VAC, 50/60 Hz for 1 minute between lamp terminals (See note 3.)
Vibration resistance	Malfunction: 10 to 55 Hz, 1.5 mm double amplitude
Shock resistance	Destruction: 500 m/s ² Malfunction: 200 m/s ²
Life expectancy	Mechanical: Momentary operation models: 1,000,000 operations min. Alternate operation models: 200,000 operations min. (One operation consists of set and reset operations.)
	Electrical: 100,000 operations min.
Weight	Approx. 30 g
Inrush current	NC: Silver alloy contact: 10 A max. NO: Silver alloy contact: 10 A max.
Ambient operating temperature	LED-lighted models: -10°C to 40°C (with no icing or condensation) Incandescent lamp-lighted models: -10°C to 50°C (with no icing or condensation)
Ambient operating humidity	35% to 85%
Ambient storage temperature	-25°C to 65°C
Degree of protection	IP40
Electric shock protection class	Class II
PTI (proof tracking index)	175
Pollution degree	3 (IEC947-5-1)

- Note:**
1. With alternate operation models, 60 operations/minute max. One operation cycle consists of set and reset operations.
 2. 600 VAC for microloads.
 3. With no incandescent lamp or LED lamp mounted.

■ Approved Standard Ratings

UL508 General Use: 5A at 125 V

CSA C22 No. 14 General Use: 5 A at 125 VAC, 3 A at 250 VAC

■ Operating Characteristics

Operating characteristics	A3PJ series		A3PA series		A3PT series	
	Momentary operation models	Alternate operation models	Momentary operation models	Alternate operation models	Momentary operation models	Alternate operation models
OF max.	5.88 N	6.86 N	5.88 N	6.86 N	3.92 N	4.90 N
RF min.	0.39 N	0.29 N	0.39 N	0.29 N	0.39 N	0.29 N
TT	Approx. 3.5 mm	Approx. 3.5 mm	Approx. 3.5 mm	Approx. 3.5 mm	Approx. 3.5 mm	Approx. 3.5 mm
PT max.	3 mm	3 mm	3 mm	3 mm	3 mm	3 mm
LTA min.	---	0.5 mm	---	0.5 mm	---	0.5 mm

Operation

Terminal connections LED-lighted Models

(The terminal arrangement diagram shows a 1-switch output. Connections to terminals from the lighting block are the same for 2 outputs.)

Rated voltage		5 VDC		12 VDC		24 VDC	
Model	Screen pattern	Bottom view	Top view	Bottom view	Top view	Bottom view	Top view
A3PJ	Single screen						
	2-split screen						
A3PA	Single screen						
	2-split screen						

Incandescent Lamp-lighted/LED Lamp-lighted Models

(All are shown with the OMRON logo facing down. The terminal arrangements are the same as for the LED-lighted models.)

Model	Rectangular A3PJ models	Square A3PA models	Round A3PT models
Silver/gold alloy contacts (1 output)			
Silver/gold alloy contacts (2 outputs)			
Silver/gold alloy contacts (3 outputs)		---	---

LED Chameleon Models

(The terminal arrangement diagram shows a 1-switch output. Connections to terminals from the lighting block are the same for 2 outputs.)

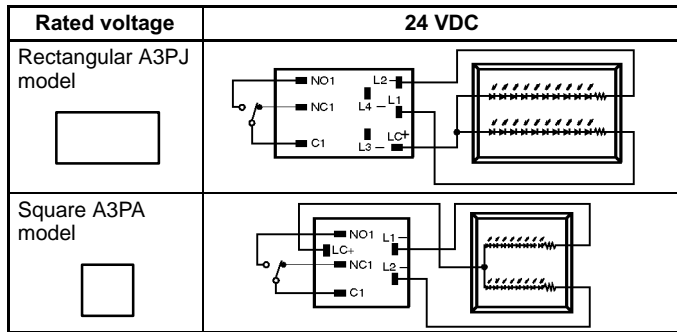

Terminal Arrangement and Coloring Chameleon Models

Wiring	LC+	LC+	LC+
	L1-	L2-	L1- and L2- shorted
Coloring	Green	Red	Orange

Panel Cutout

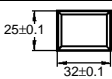
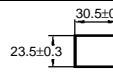
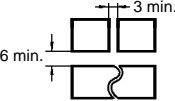
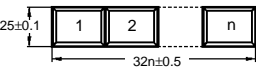
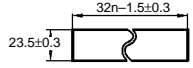
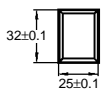
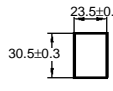
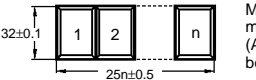
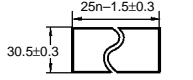
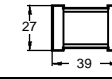
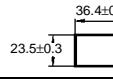
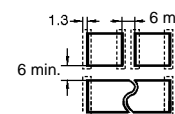
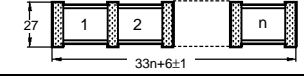
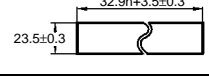
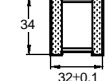
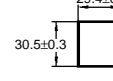
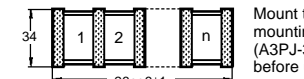
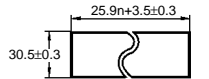

(If using a Switch Guard or Seal Cover, refer to the panel cutout diagrams on page 244.)

A3PJ (Rectangular) Models

Classification	Mounting design	Panel cutout	Remarks
Flange mount models	Individual mounting (Horizontal) 		Panel cutout spacing between rows of Units: 
	Multiple mounting (Horizontal) 		
	Individual mounting (Vertical) 	Mount to long mounting plate (A3PJ-3002) before use. 	
	Multiple mounting (Vertical) 	Mount to long mounting plate (A3PJ-3002) before use. 	
Barrier mount models	Individual mounting (Horizontal) 		For barrier mount models, refer to Accessories on page 234. Panel cutout spacing between rows of Units: (Dotted line indicates the position of each mounting barrier.) 
	Multiple mounting (Horizontal) 		
	Individual mounting (Vertical) 	Mount to long mounting plate (A3PJ-3002) before use. 	
	Multiple mounting (Vertical) 	Mount to long mounting plate (A3PJ-3002) before use. 	

- Note:**
1. n: Number of Units
 2. Recommended panel thickness: 1 to 5 mm
 3. Mount the panel before mounting the Switch Guard.
 4. If the panel is to be finished (e.g., coated), make sure that the panel meets the specified dimensions after the coating.

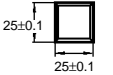
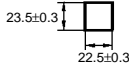
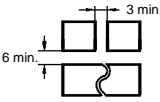
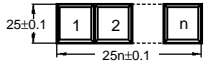
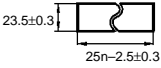
A3PA (Square) Models

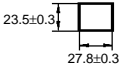
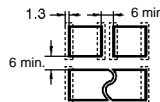
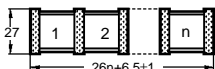
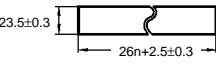
Classification		Mounting design	Panel cutout	Remarks
Flange mount models	Individual mounting			Panel cutout spacing between rows of Units: 
	Multiple mounting			
Barrier mount models	Individual mounting			Panel cutout spacing between rows of Units: (Dotted line indicates the position of each mounting barrier.) 
	Multiple mounting			

- Note:**
1. n: Number of Units
 2. Recommended panel thickness: 1 to 5 mm
 3. Mount the panel before mounting the Switch Guard.
 4. If the panel is to be finished (e.g., coated), make sure that the panel meets the specified dimensions after the coating.

A3PT (Round) Models

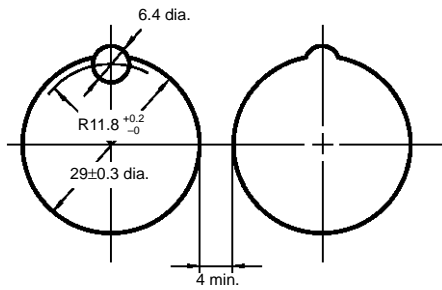

Dimensions

Note: All units are in millimeters unless otherwise indicated.

A3PJ (Rectangular) Models

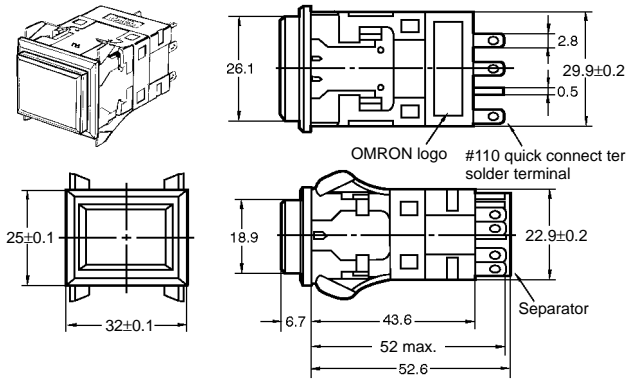

A3PA (Square) Models

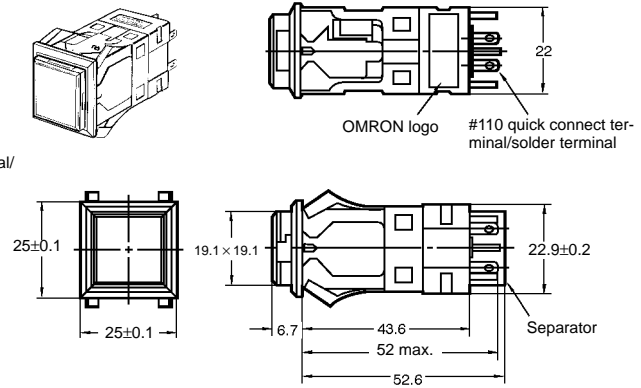

A3PT (Round) Models

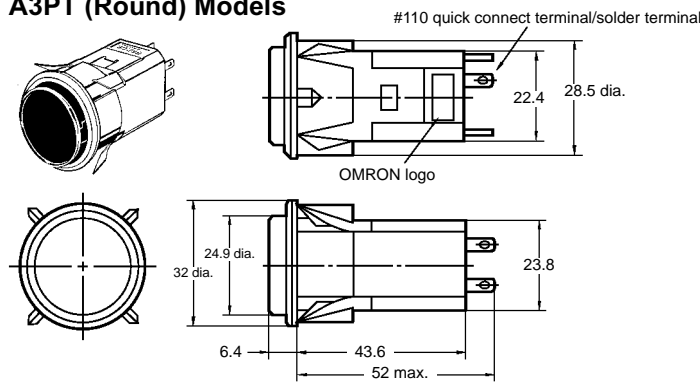

■ Accessory Mounting Dimensions

● Legend Plate

Rectangular Models A3PJ-5201/-5202

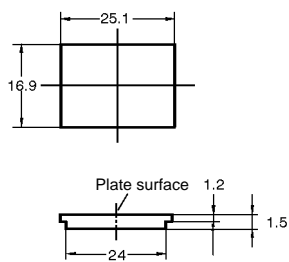

Square Models A3PA-5201/-5202

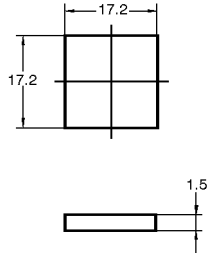

Extractor A3PJ-5080

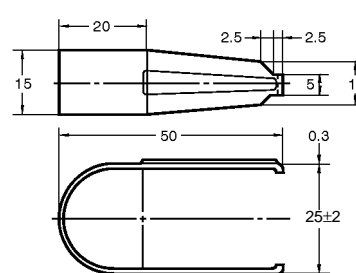

Note: Made from stainless steel.

● Socket-mounting Dimensions

Rectangular Models
A3PJ (M2PJ)

Square Models
A3PA (M2PA)

Wire-wrap Terminal
A3PJ-4101

Wire-wrap Terminal
A3PA-4101

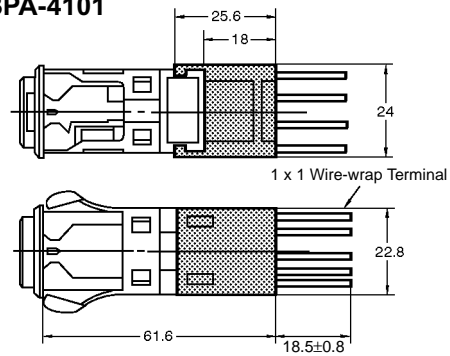
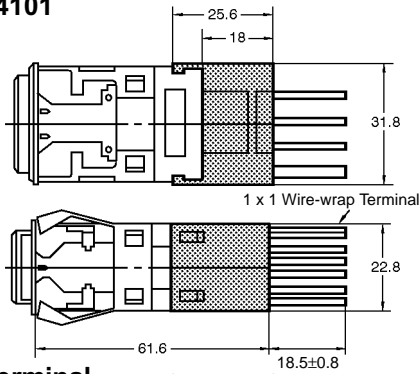

PCB Terminal
A3PJ-4102

PCB Terminal
A3PA-4102

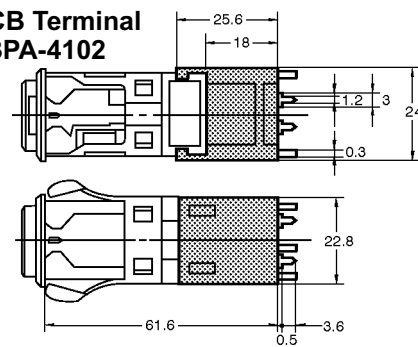
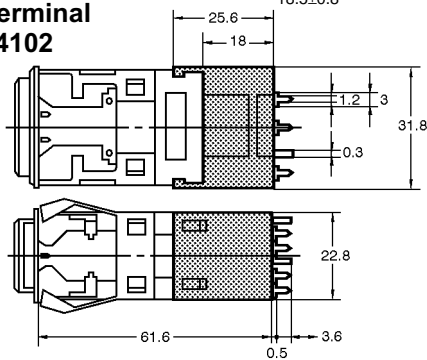

PCB Cutout (bottom view)

PCB Cutout (bottom view)

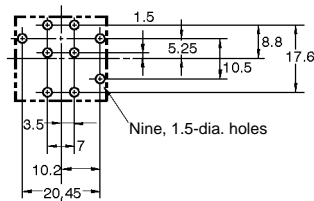
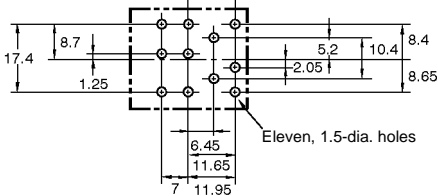

Solder Terminal
A3PJ-4103

Solder Terminal
A3PA-4103

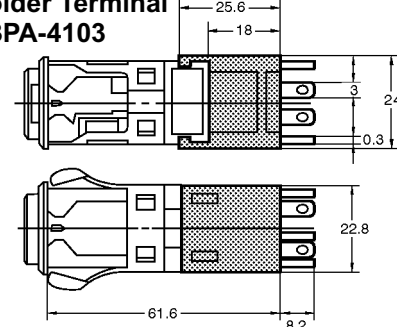
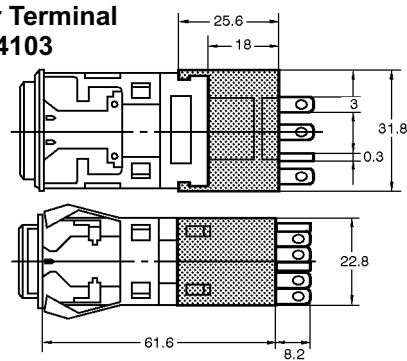

Terminal Hole Dimensions

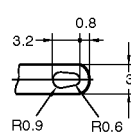

Terminal Hole Dimensions

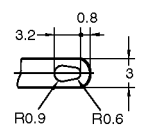

Note: PCB cutout dimensions show the switch mounted to the socket with the OMRON logo facing down.

● Switch and Guard Mounting Dimensions

Rectangular Models
A3PJN-5050 (Horizontal Mounting)
A3PJN-5055 (Vertical Mounting)

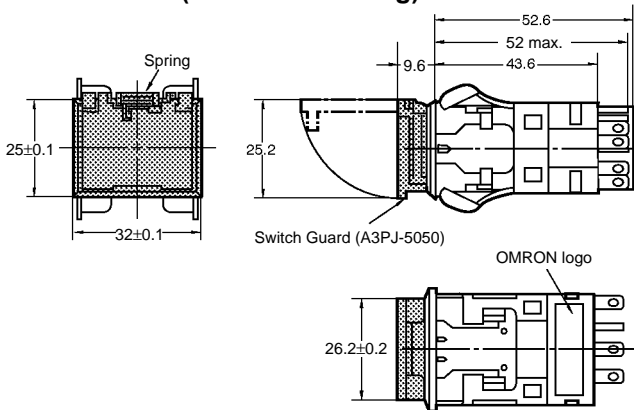

Panel Cutouts

Individual Mounting (Horizontal)

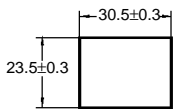

Multiple Mounting (Horizontal)

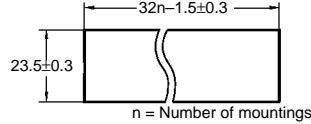

Note: Multiple vertical mounting is not possible.

Square Models
A3PAN-5050 (Horizontal Mounting)
A3PAN-5055 (Vertical Mounting)

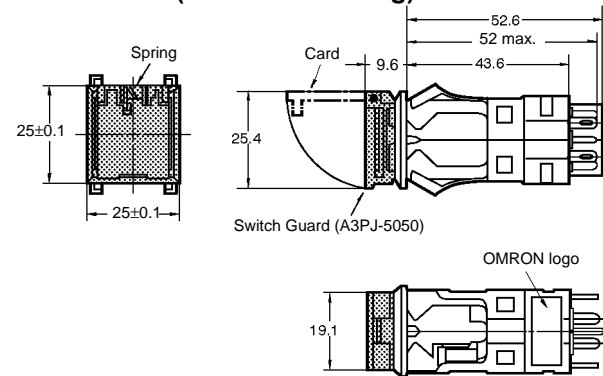

Panel Cutouts

Individual Mounting (Horizontal)

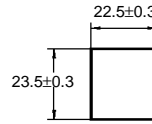

Multiple Mounting (Horizontal)

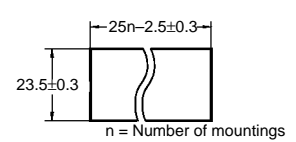

Note: Multiple vertical mounting is not possible.

● Seal Cover Mounting Dimensions

Rectangular Models
A3PJ-5060

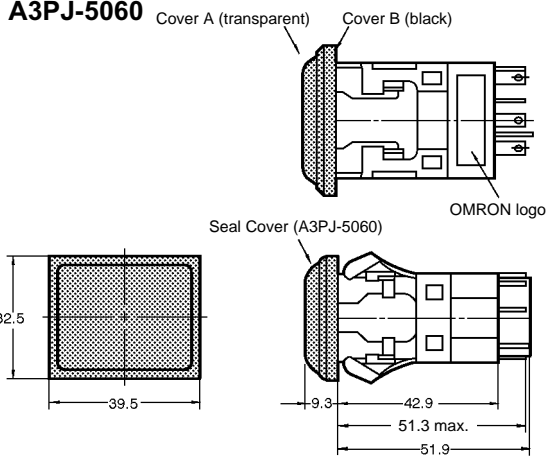

Panel Cutouts

Individual Mounting (Horizontal)

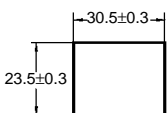

Multiple Mounting (Horizontal)

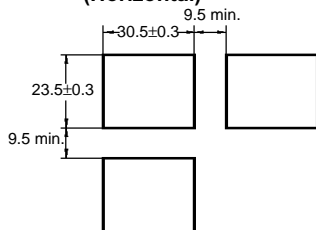

Square Models
A3PA-5060

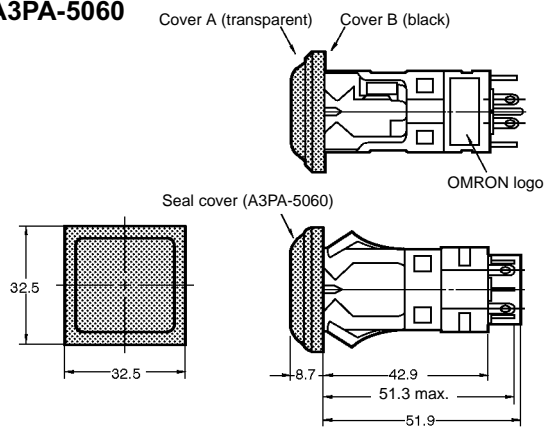

Panel Cutouts

Individual Mounting

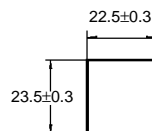

Multiple Mounting

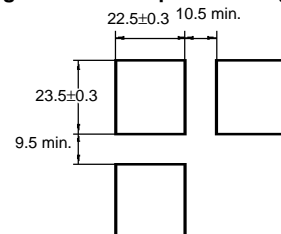

Note: 1. Recommended panel thickness: 1 to 5 mm
 2. Unless otherwise specified, a tolerance of ±0.4 mm applies to all dimensions.

Precautions

Caution

Do not apply a voltage higher than the maximum rated operating voltage between the lamp terminals, as there is a risk that the incandescent lamp or LED will be damaged, and the Pushbutton will be ejected.

When replacing the incandescent lamp, first turn OFF the power supply, and then wait 10 minutes before performing replacement, as the lamp is still hot immediately after the power is turned OFF, so there is a risk of burns.

Refer to the *Common Precautions* for Pushbutton Switches on page 14.

Correct Use

Mounting

Always make sure that the power is turned OFF before mounting, removing, or wiring the Switch, or performing maintenance.

After wiring the Switch, make sure that there is a suitable isolation distance.

Wiring

Perform soldering promptly and correctly at 60 W maximum and within 3 seconds. (Dip soldering temperature 280°C max.) Wait for one minute after soldering before exerting any external force on the solder.

Operating Environment

Do not use in locations that are subject to dust, oil, or metal filings as these may penetrate the interior of the Switch and cause malfunction.

LED (for VDC)

Check the terminal polarity when wiring.

The rated voltage is shown on the plate on the back of the lighting unit, so be sure to use within the voltage shown.

An LED current-limiting resistor is built in, so there is no need to mount an external resistor.

Incandescent Lamp

Apply 80% of the rated voltage (operating voltage) to the incandescent lamp to improve life expectancy and incandescence.

Character Plate (Character Film)

If preparing the character plate separately, use a heat-resistant film with a thickness of 0.1 to 0.3 mm.

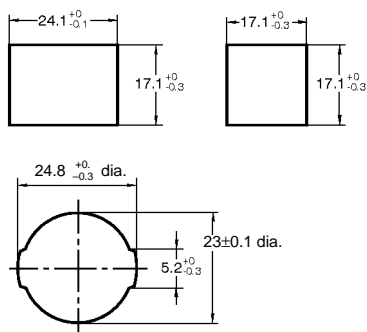

Using Microloads

Using a standard load switch when a microload circuit is opened or closed may cause wear on the contacts. Use the switch within the operating range. (Refer to the diagram below.) Even when using microload models within the operating range shown below, if inrush current occurs when the contact is opened or closed, it may cause the contact surface to become rough, and so decrease life expectancy. Therefore, insert a contact protection circuit where necessary. The minimum applicable load is the N-level reference value. This value indicates the malfunction reference level for the reliability level of 60% (λ 60) (conforming to JIS C5003). The equation, λ 60 = $0.5 \times 10^{-4}/\text{time}$ indicates that the estimated malfunction rate is less than 1/2,000,000 with a reliability level of 60%.

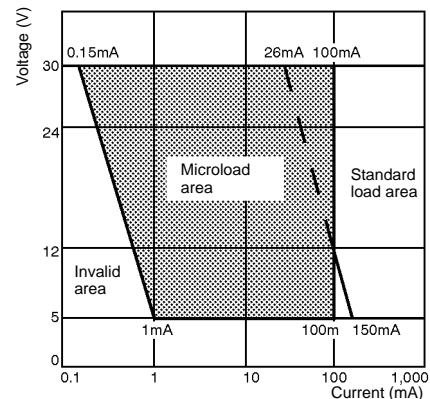

Others

If the panel is to be finished (e.g., coated), make sure that the panel meets the specified dimensions after the coating.

■ Assembly/Disassembly
A3PJ/M2PJ (Rectangular Models)
A3PA/M2PA (Square Models)

1. Locking/Unlocking Positive Cap Lock Mechanism

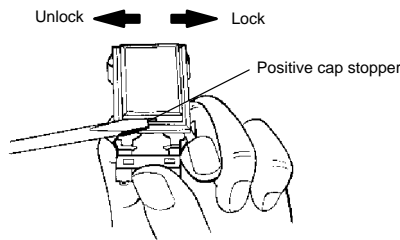

2. Mounting Pushbutton

Be sure to mount the Pushbutton with the correct orientation. Align the groove on the Pushbutton, the projections in the Switch, and the LED contact piece before pushing the Pushbutton into the Switch.

When dismantling the Pushbutton, use the Extractor (A3PJ-5080) for easy dismantling.

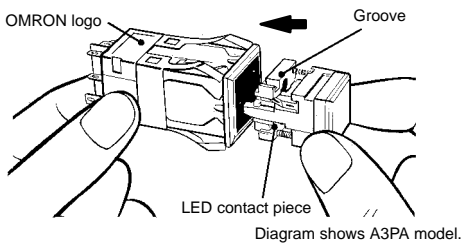

3. Removing/Mounting Cap

Insert the A3PA from the open side into the theft-prevention stopper.

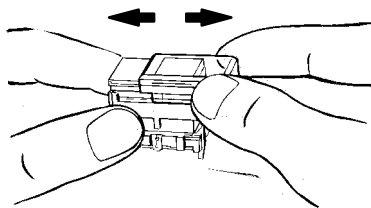

4. Mounting Colored Plate

Place the colored plate on the plunger case with the dull side of the colored plate facing downward. With A3PJ split-screen models, be sure that the projections on the upper surface of the colored plate face outward. For the A3PA, make sure that the flat plate is facing upwards.

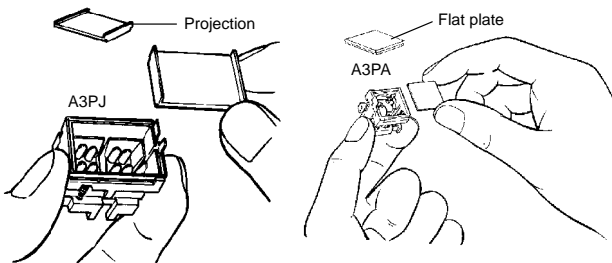

5. Mounting Character Plate (Character Frame) and Legend Plate

Mount the legend plate for the A3PJ under the layered surfaces and mount the cap, as shown below.

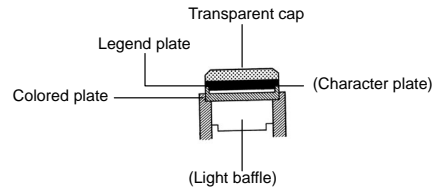

6. Mounting and Replacing LED and Incandescent Lamps

If using an A3PA (square) model with one incandescent lamp, insert the lamp in the center hole.

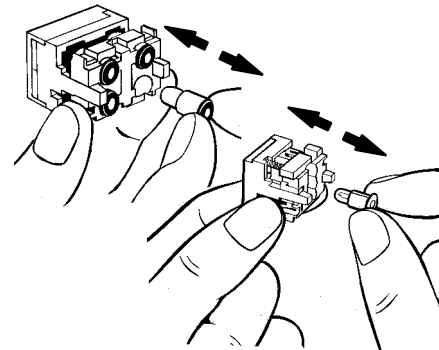

Note: Built-in LEDs cannot be replaced.

7. LED Rated Voltage Display (LED Models Only)

The LED rated voltage is shown between the built-in resistors on the back of the lighting unit. Use within a range of $\pm 5\%$.

A3PJ

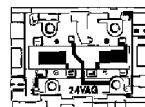

Rated voltage display

A3PA



Note: Display is on the back.

8. Mounting Switch onto Panel

- Individual Mounting and Barrier Mounting

When mounting the Switch, push it into the panel cutout from the front of the mounting panel by holding it with the logo mark "OMRON" facing downward.

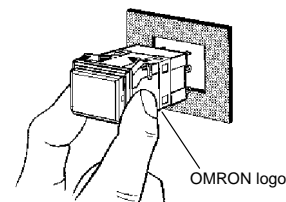

- Multiple Barrier Mounting (A3PJ)

When mounting a number of Switches in line on the panel, link the Switches with spacing barriers in between, attach mounting barriers at both sides of this block of Switches and, pushing in on the mounting barriers at the side, insert the Switches into the panel cutout together.

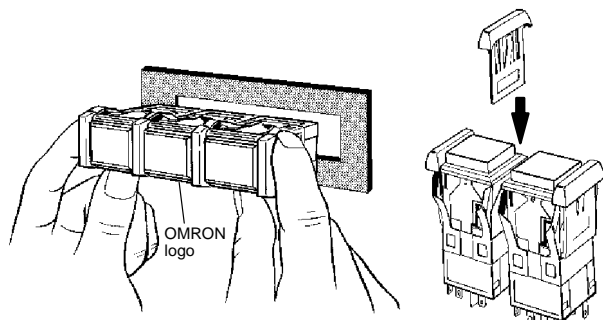

9. Mounting Barriers

Mount each part by pushing it in the direction of the arrow shown in the corresponding illustration below.

Barrier mounting

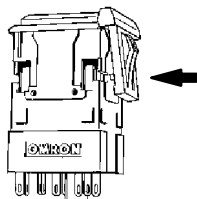

10. Mounting Seal Cover

After mounting the seal cover onto the flange of the Switch, push the Switch into the panel cutout.

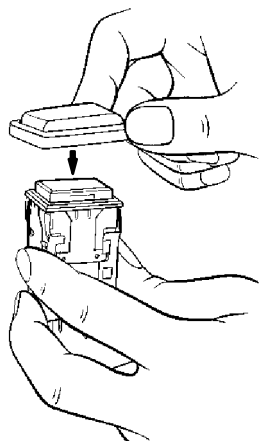

11. Inscribing the Legend Plate

- Inscribe the legend plate to a depth of 0.5 mm max.
- The legend plate is made from polycarbonate resin. To coat the legend plate, use an alcohol-based coating such as melamine, phthalic acid, or acrylic.

ALL DIMENSIONS SHOWN ARE IN MILLIMETERS.

To convert millimeters into inches, multiply by 0.03937. To convert grams into ounces, multiply by 0.03527.

Large Rectangular-bodied Indicators

- Good illumination with even surface brightness.
- Three-color models (green, orange, red; chameleon lighting) included in lineup.
- UL and CSA approved.

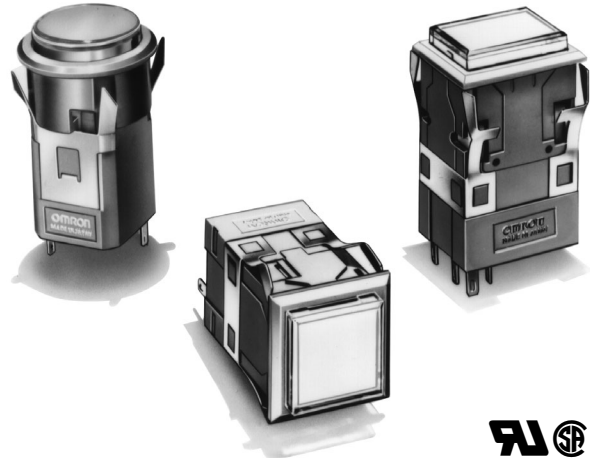

Ordering Information

■ Model Number Legend

The model numbers used to order sets of Units are illustrated below. One set comprises the Display, Lamp, and Socket.

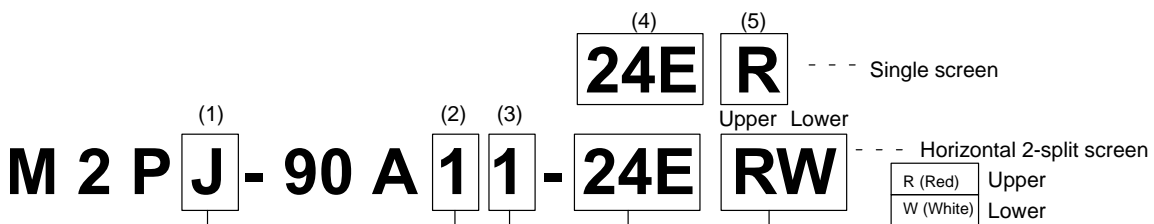

(1) Shape of Display

Symbol	Shape
J	Rectangular
A	Square
T	Round

(2) Screen Pattern

Illumination-only models	
Symbol	Screen pattern
1	Single screen
2	2-split screen
G	Chameleon (see note 1, 2)

- Note:** 1. The chameleon screen pattern is not available with M2PT models.
2. The chameleon screen pattern is only available with 12 or 24-VDC models.
3. With chameleon models, the whole screen lights red, green, or orange. When not lit, the display is white.

The available rectangular models are shown below. Select from among the individual products shown on page 257.

Vertical 2-split screen models



4-split screen models



Horizontal 3-split screen models



Vertical 3-split screen models



The above diagrams show the Sockets with the "OMRON" mark facing down.

Colored-illumination models up to the 4-split screen models are available as individual Units. Refer to page 255.

"Colored-illumination" models operate in the way shown below:

Unlit	Lit
White	Color

The built-in LED is colored.

(3) Case Color

Symbol	Color
1	Black
2	Light gray

Note: M2PT model is available in light gray only.

(4) Lighting Method LED-lighted Models (M2PJ and M2PA Only)

Symbol	Rated voltage
05E	5 VDC
12E	12 VDC
24E	24 VDC

LED Lamp-lighted Models (M2PT Only)

Symbol	Rated voltage
05C	5 VDC
12C	12 VDC
24C	24 VDC

M2PJ and M2PA can also be ordered separately. Refer to page 257 for details.

Incandescent Lamp-lighted Models

Symbol	Rated voltage
06	6 VAC/VDC
14	14 VAC/VDC
28	28 VAC/VDC

(5) Color of Display For LED

Symbol	Color
R	Red
O	Orange
G	Green
W	White
K	Chameleon

The chameleon screen pattern is not available with M2PT models.

The chameleon screen pattern is only available with 12 or 24-VDC models.

For Incandescent Lamp

Symbol	Color
No symbol	Red, orange, white, blue, green

Includes colored plate. Refer to page 258 for details.

Number of Built-in LED Lamps

Screen pattern	A3PJ	A3PA	A3PT
Single screen	Built-in LED models		2
Horizontal 2-split screen			2
Vertical 2-split screen	4 (See note.)	---	---
Horizontal 3-split screen		---	---
Vertical 3-split screen		---	---
4-split screen		---	---

Number of Built-in Incandescent Lamps

Screen pattern	A3PJ	A3PA	A3PT
Single screen	2	1	2
Horizontal 2-split screen	4 (Low-power incandescent lamp)	2	2
Vertical 2-split screen		---	---
Horizontal 3-split screen		---	---
Vertical 3-split screen		---	---
4-split screen		---	---

Note: These split screen models are available only as individual Units. They cannot be ordered as sets.

■ List of Models

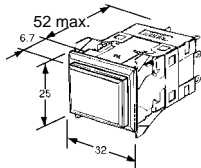
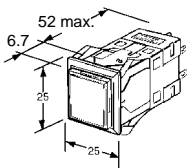
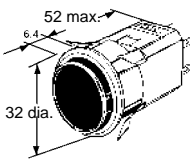
Model	M2PJ (Rectangular)	M2PA (Square)	M2PT (Round)
Appearance			

■ Construction

Lighting method	LED-lighted models (LED is built-in.)		LED lamp-lighted models (LED is not built-in.)				Incandescent lamp-lighted models (Incandescent lamp is not built-in.)			
Models	M2PJ	M2PA	M2PJ	M2PA	M2PT	M2PJ	M2PA	M2PT		
Screen pattern	Single screen Horizontal 2-split screen Chameleon (3-color) 	Single screen Horizontal 2-split screen Chameleon (3-color) 	Single screen Horizontal 2-split screen Vertical 2-split screen 	Vertical 3-split screen Horizontal 3-split screen 4-split screen 	Single screen Horizontal 2-split screen 	Single screen 	Single screen Horizontal 2-split screen Vertical 2-split screen 	Vertical 3-split screen Horizontal 3-split screen 4-split screen 	Single screen Horizontal 2-split screen 	Single screen

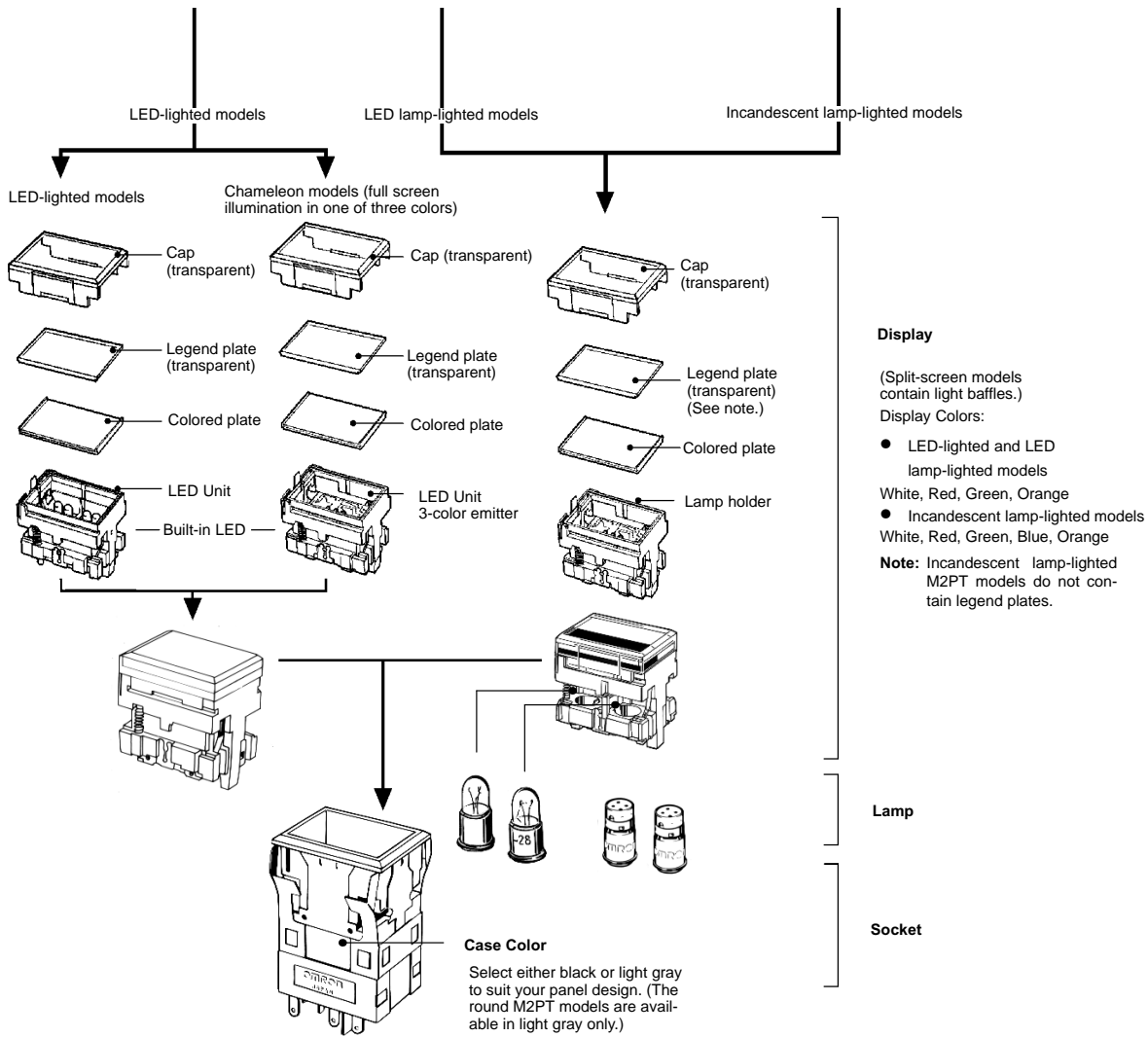

Note: The above diagram for LED lamp-lighted and incandescent lamp-lighted models shows the M2PJ model.

■ M2P Lighting Method Diagram

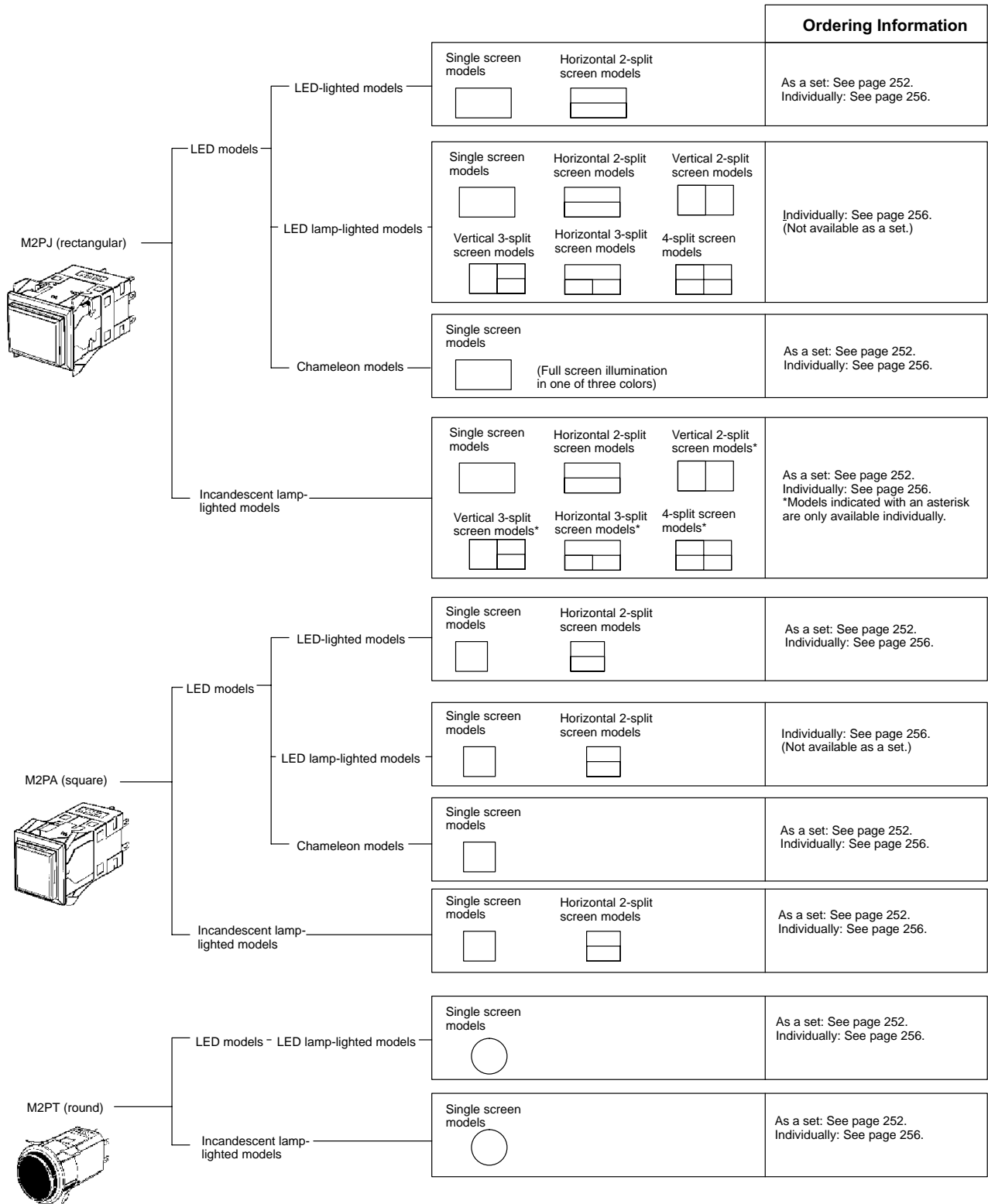

■ Ordering as a Set

The model numbers used to order sets of Units are given in the following tables. One set comprises the Display, Lamp, and Socket.

M2PJ (Rectangular) Single Screen Models

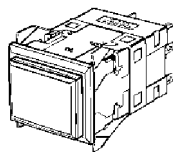

(1)

Lighting method		Case color	Black	Light gray	Display color symbol
LED	5 VDC		M2PJ-90A11-05E(1)	M2PJ-90A12-05E(1)	R O G W
	12 VDC		M2PJ-90A11-12E(1)	M2PJ-90A12-12E(1)	
	24 VDC		M2PJ-90A11-24E(1)	M2PJ-90A12-24E(1)	
Chameleon	12 VDC		M2PJ-90AG1-12EK	M2PJ-90AG2-12EK	(See note 1.)
	24 VDC		M2PJ-90AG1-24EK	M2PJ-90AG2-24EK	
Incandescent lamp	6 VDC/VAC		M2PJ-90A11-06	M2PJ-90A12-06	(See note 2.)
	14 VDC/VAC		M2PJ-90A11-14	M2PJ-90A12-14	
	28 VDC/VAC		M2PJ-90A11-28	M2PJ-90A12-28	

Enter the desired color symbol for the Display in (1). (R) = Red, (O) = Orange, (G) = Green, (W) = White.

Example: Red MPJ-90A11-24ER

- Note:**
1. You can change the screen colors of chameleon models between red, green, and orange by changing the terminal wiring. Refer to page 260 for details.
 2. Incandescent lamps are supplied with colored plates (white, red, green, blue, and orange) and legend plates (milk-white and transparent). Use the appropriate combination.

M2PJ (Rectangular) Horizontal 2-split Screen Models

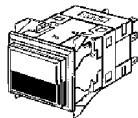

(1)
(2)

Lighting method		Case color	Black	Light gray	Display color symbol
LED	24 VDC		M2PJ-90A21-24E(1)(2)	M2PJ-90A22-24E(1)(2)	R O G W
Incandescent lamp	6 VDC/VAC		M2PJ-90A21-06	M2PJ-90A22-06	(See note.)
	14 VDC/VAC		M2PJ-90A21-14	M2PJ-90A22-14	
	28 VDC/VAC		M2PJ-90A21-28	M2PJ-90A22-28	

Enter the desired color symbols for the Display in (1) and (2). (R) = Red, (O) = Orange, (G) = Green, (W) = White.

Example:

Red	Upper
White	Lower

 M2PJ-90A21-24ERW
Red White

- Note:** Incandescent lamps are supplied with colored plates (white, red, green, blue, and orange) and legend plates (milk-white and transparent). Use the appropriate combination.

M2PA (Square) Single Screen Models

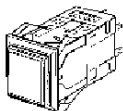

(1)

Lighting method	Case color	Black	Light gray	Display color symbol
LED	5 VDC	M2PA-90A11-05E(1)	M2PA-90A12-05E(1)	R O G W
	12 VDC	M2PA-90A11-12E(1)	M2PA-90A12-12E(1)	
	24 VDC	M2PA-90A11-24E(1)	M2PA-90A12-24E(1)	
Chameleon	12 VDC	M2PA-90AG1-12EK	M2PA-90AG2-12EK	(See note 1.)
	24 VDC	M2PA-90AG1-24EK	M2PA-90AG2-24EK	
Incandescent lamp	6 VDC/VAC	M2PA-90A11-06	M2PA-90A12-06	(See note 2.)
	14 VDC/VAC	M2PA-90A11-14	M2PA-90A12-14	
	28 VDC/VAC	M2PA-90A11-28	M2PA-90A12-28	

Enter the desired color symbol for the Display in (1). (R) = Red, (O) = Orange, (G) = Green, (W) = White.

Example: Red M2PA-90A11-24ER

- Note:**
1. You can change the screen colors of chameleon models between red, green, and orange, by changing the terminal wiring. Refer to page 260 for details.
 2. Incandescent lamps are supplied with colored plates (white, red, green, blue, and orange) and legend plates (milk-white and transparent). Use the appropriate combination.

M2PA (Square) Horizontal 2-split Screen Models

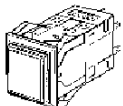

(1)

(2)

Lighting method	Case color	Black	Light gray	Display color symbol
LED	24 VDC	M2PA-90A21-24E(1)(2)	M2PA-90A22-24E(1)(2)	R O G W
Incandescent lamp	6 VDC/VAC	M2PA-90A21-06	M2PA-90A22-06	(See note.)
	14 VDC/VAC	M2PA-90A21-14	M2PA-90A22-14	
	28 VDC/VAC	M2PA-90A21-28	M2PA-90A22-28	

Enter the desired color symbols for the Display in (1) and (2). (R) = Red, (O) = Orange, (G) = Green, (W) = White.

Example: Red Upper M2PA-90A21-24ERW
White Lower Red W White

- Note:** Incandescent lamps are supplied with colored plates (white, red, green, blue, and orange) and legend plates (milk-white and transparent). Use the appropriate combination.

M2PT (Round) Single Screen Models



(1)

Lighting method		Case color	Light gray	Display color symbol
LED	5 VDC		M2PT-90A12-05C(1)	R O G W
	12 VDC		M2PT-90A12-12C(1)	
	24 VDC		M2PT-90A12-24C(1)	
Incandescent lamp	6 VDC/VAC		M2PT-90A12-06	(See note.)
	14 VDC/VAC		M2PT-90A12-14	
	28 VDC/VAC		M2PT-90A12-28	

Enter the desired color symbol for the Display in (1). (R) = Red, (O) = Orange, (G) = Green, (W) = White.

Example: Red M2PT-90A12-24CR

Note: Incandescent lamps are supplied with a colored plates (white, red, green, blue, and orange). Use the appropriate combination. Models A3PT and M2PT (round models), however, are not supplied with legend plates.

■ Illumination-only and Colored-illumination LED Models

- “Illumination only” describes LED models for which the screen color is the same whether the LED is lit or not. The screen simply becomes brighter when the LED lights.

Example: Red LED

Not lit



Lit

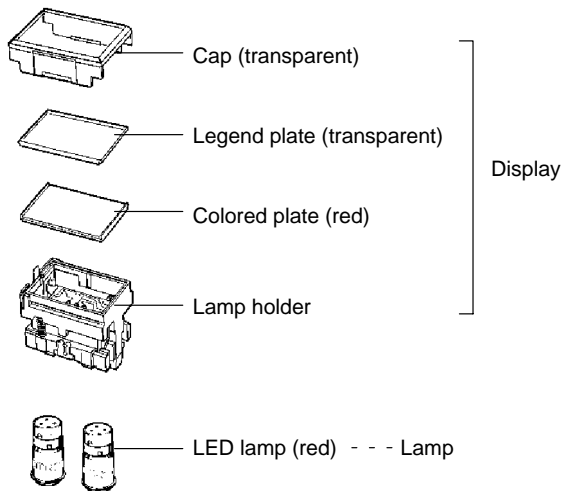

- “Colored illumination” describes LED models for which the screen color is white when the LED is not lit and changes to the color of the LED lamp when the LED is lit.

Example: Red LED

Not lit



Lit

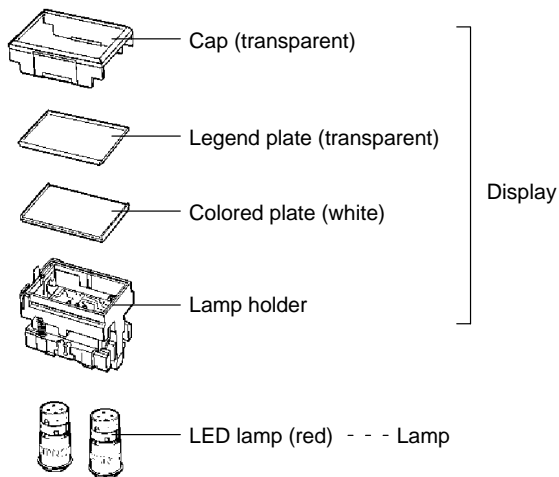

Ordering: For a colored-illumination Indicator, order the Display, Lamp, and Socket as shown in the following table.

Display	Lamp	Socket
Select the LED lamp-lighted model required from the selection on page 257. Each assembly includes the number of white colored plates required to enable colored illumination for the corresponding screen-split configuration. For example, 4-split screen models includes 4 white colored plates.	Select the LED lamps to suit your desired coloration from the selection on page 258. Number of necessary LED lamps (standard): M2PJ (rectangular): 4 M2PA (square): 2 M2PT (round): 2	Select from the <i>Sockets</i> on page 259.

■ Ordering Individually

Displays, Lamps, and Sockets can be ordered separately. Combinations that are not available as sets can be created using individual Units. Also, store the parts as spares for maintenance and repairs.

LED-lighted/Chameleon Models

(LED is built into the Display.)

Display
Round (M2PT) models not available.

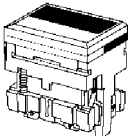

M2P□-5□□□-□□E
(for Indicator)

LED Lamp-lighted Models

(LED lamp and Display are separate.)

Display

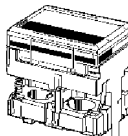

M2P□-502□
(for Indicator)

Incandescent Lamp-lighted Models

(Incandescent lamp and Display are separate.)

Display

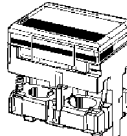

M2P□-501□
(for Indicator)

Lamp (LED Lamp)
(See note 2.)



SLL-□□□E□

Lamp (Incandescent Lamp)
(See note 3.)



Standard lamp: SLL-□□
Low-power lamp: SLL-□□H

Socket (See note 1.)

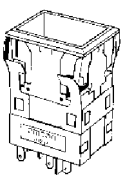

M2P□-7□□□□-□
(for Indicator)

Socket

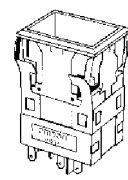

M2P□-7□□□□-□
(for Indicator)

Socket

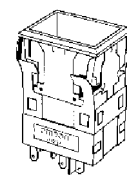

M2P□-7□□□□-□
(for Indicator)











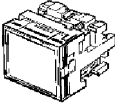

- Note:** 1. The Socket is compatible with LED-lighted, LED lamp-lighted, and incandescent lamp-lighted models.
2. Number of necessary LED lamps.
3. Number of necessary incandescent lamps.

Screen pattern	M2PJ	M2PA	M2PT
Single screen	4	2	2
Horizontal 2-split screen		2	2
Vertical 2-split screen		---	---
Vertical 3-split screen		---	---
Horizontal 3-split screen		---	---
4-split screen		---	---

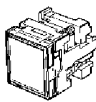
Screen pattern	M2PJ	M2PA	M2PT
Single screen	2	1	2
Horizontal 2-split screen	4 (low-power incandescent lamp)	2	2
Vertical 2-split screen		---	---
Vertical 3-split screen		---	---
Horizontal 3-split screen		---	---
4-split screen		---	---

Display









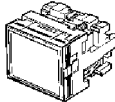
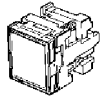

LED-lighted Models (LED is built-in.)

Appearance	Split-screen color (color symbol)	White (W)	Red (R)	Green (G)	Orange (O)	Selection precautions	
Rectangular models 	Single screen		M2PJ-5701-□□E	M2PJ-5702-□□E	M2PJ-5703-□□E	M2PJ-5706-□□E	Enter the voltage to be used in the □□ at the end of the model number. Examples of voltage used: 5 V = <u>0</u> <u>5</u> E 12 V = <u>1</u> <u>2</u> E 24 V = <u>2</u> <u>4</u> E For the color of the shaded part, select the model according to the colors given at the top of the table.
	Horizontal 2-split screen		M2PJ-5711-□□E	M2PJ-5712-□□E	M2PJ-5713-□□E	M2PJ-5716-□□E	
			M2PJ-5721-□□E	M2PJ-5722-□□E	M2PJ-5723-□□E	M2PJ-5726-□□E	
			M2PJ-5731-□□E	M2PJ-5732-□□E	M2PJ-5733-□□E	M2PJ-5736-□□E	
			M2PJ-5741-□□E	M2PJ-5742-□□E	M2PJ-5743-□□E	M2PJ-5746-□□E	
Square models 	Single screen		M2PA-5701-□□E	M2PA-5702-□□E	M2PA-5703-□□E	M2PA-5706-□□E	
	Horizontal 2-split screen		M2PA-5711-□□E	M2PA-5712-□□E	M2PA-5713-□□E	M2PA-5716-□□E	
			M2PA-5721-□□E	M2PA-5722-□□E	M2PA-5723-□□E	M2PA-5726-□□E	
			M2PA-5731-□□E	M2PA-5732-□□E	M2PA-5733-□□E	M2PA-5736-□□E	
			M2PA-5741-□□E	M2PA-5742-□□E	M2PA-5743-□□E	M2PA-5746-□□E	

Note: 1. A cap, legend plate (transparent), colored plate, white plunger case, and LED (with a current-limiting resistor) are built into the standard lighting unit.

2. Split-screen coloring configurations are given with the **OMRON** mark on the Sockets facing down.

LED Lamp-lighted Models (LED is not built-in.)

Model	Rectangular models 		Square models 		Round models 	
Screen pattern	Screen	Model	Screen	Model	Screen	Model
Single screen		M2PJ-5021		M2PA-5021		M2PT-5021
Horizontal 2-split screen		M2PJ-5022		M2PA-5022	---	---
Vertical 2-split screen		M2PJ-5023	---	---	---	---
Horizontal 3-split screen		M2PJ-5024	---	---	---	---
Vertical 3-split screen		M2PJ-5025	---	---	---	---
4-split screen		M2PJ-5026	---	---	---	---













Note: 1. Colored plates (white, red, green, and orange), a legend plate (transparent), and a light baffle (split-screen models only) are included. Use the appropriate combination for the LED coloring required.

2. The number of white colored plates required to enable colored illumination for the corresponding screen-split configuration is included. (For example, 4-split screen models include 4 white colored plates). The number of colored plates included for each model are shown in the following table.

Screen pattern	White	Red	Green	Orange
Single screen	1	1	1	1
Horizontal 2-split screen Vertical 2-split screen	2	1	1	1
Horizontal 3-split screen Vertical 3-split screen	3	2	2	2
4-split screen	4	1	1	1

Display

Incandescent Lamp-lighted Models (Incandescent lamp is not built-in.)

Model	Rectangular models		Square models		Round models	
						
Screen pattern	Screen	Model	Screen	Model	Screen	Model
Single screen		M2PJ-5011		M2PA-5011		M2PT-5011
Horizontal 2-split screen		M2PJ-5012		M2PA-5012	---	
Vertical 2-split screen		M2PJ-5013	---		---	
Horizontal 3-split screen		M2PJ-5014	---		---	
Vertical 3-split screen		M2PJ-5015	---		---	
4-split screen		M2PJ-5016	---		---	

- Note:**
1. Colored plates (white, red, green, orange, and blue), a legend plate (transparent), and a light baffle (split-screen models only) are supplied.
 2. M2PT (round) models do not contain a legend plate.
 3. The number of colored plates supplied is shown in the following table.

Screen pattern	White	Red	Green	Orange	Blue
Single screen	1	1	1	1	1
Horizontal 2-split screen	1	1	1	1	1
Vertical 2-split screen	1	1	1	1	1
Horizontal 3-split screen	2	2	2	2	2
Vertical 3-split screen	2	2	2	2	2
4-split screen	2	2	2	2	2

Chameleon Models (with Built-in LED)

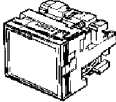
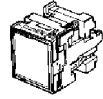
Shape	Rated voltage	Chameleon indicator
	12 VDC	M2PJ-5800-12E
	24 VDC	M2PJ-5800-24E
	12 VDC	M2PA-5800-12E
	24 VDC	M2PA-5800-24E

- Note:**
1. With the chameleon models, the whole screen lights red, green, or orange (i.e., red and green simultaneously).
 2. A cap, legend plate (transparent), white colored plate, and LED (with a current-limiting resistor) are built into the Display.

Lamp (For mounting, refer to page 246.)

LED Lamp

Voltage	5 VDC	12 VDC	24 VDC	Applicable cap (color) (colored plate)	Selection precautions
Color	Model (DC only)	Model (DC only)	Model (DC only)		
Red	SLL-05ER	SLL-12ER	SLL-24ER	Red	In the standard setup, 4 LED lamps are used with M2PJ models and 2 LED lamps are used with M2PA and M2PT models.
Yellow	SLL-05EY	SLL-12EY	SLL-24EY	Orange	
Green	SLL-05EG	SLL-12EG	SLL-24EG	Green	
White	SLL-05EW	SLL-12EW	SLL-24EW	White	

Incandescent Lamp

Lamp type	Standard lamp	Low-voltage lamp	Selection precautions
Voltage			
5 VAC/VDC	SLL-06	SLL-06H	In the standard setup for M2PJ models, 2 lamps are used with single screen models, and 4 lamps are used with split-screen models. If 3 or 4 lamps are lit continuously, use low-power lamps. In the standard setup for M2PA models, 1 lamp is used with single screen models, and 2 lamps are used with split-screen models. In the standard setup for M2PT models, 2 lamps are used.
12 VAC/VDC	SLL-14	SLL-14H	
24 VAC/VDC	SLL-28	SLL-28H	

Socket (common to both incandescent lamp-lighted and LED-lighted models)

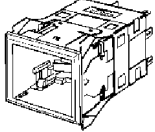
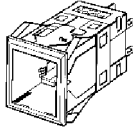
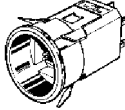
Rectangular	Square	Round	Selection precautions
			
M2PJ-7010-1	M2PA-7010-1	M2PT-7010-2	The end digit denotes the color of the flange: -1 denotes a black flange, and -2 denotes a light gray flange. Round switches are available only in light gray, and not in black.

■ Accessories













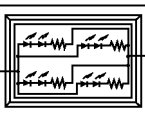
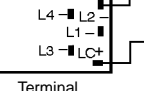
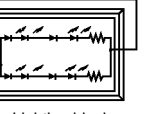
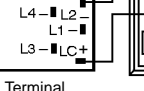
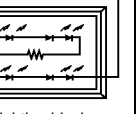

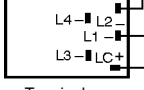
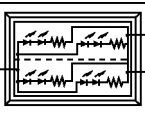

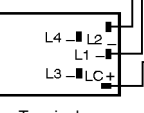
Accessories are the same as those for the A3P Lighted Pushbutton Switches. Refer to page 234.

■ LED and Incandescent Lamp Ratings and Characteristics

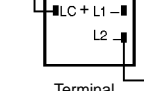
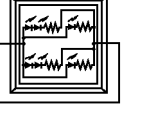
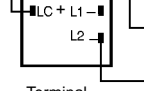
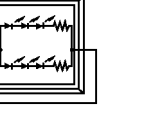
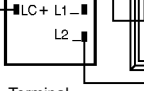
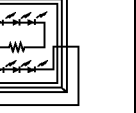
Ratings and characteristics the same as those for the A3P Lighted Pushbutton Switches. Refer to page 237.

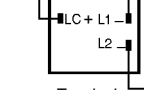
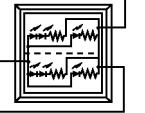
Operation

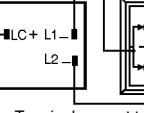
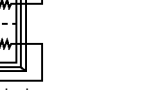
Terminal connections LED-lighted Models



Rated voltage		5 VDC		12 VDC		24 VDC	
Model	Screen pattern	Bottom view	Top view	Bottom view	Top view	Bottom view	Top view
M2PJ	Single screen 						
	2-split screen 						
M2PA	Single screen 						
	2-split screen 						

Incandescent Lamp-lighted/LED Lamp-lighted Models

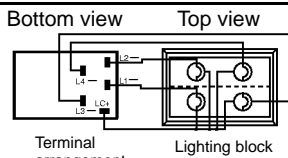
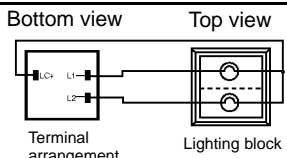
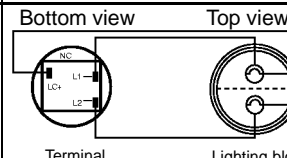
(All are shown with the OMRON logo facing down. The terminal arrangements are the same as for the LED-lighted models.)

Model	Rectangular M2PJ models	Square M2PA models	Round M2PT models
Indicator			

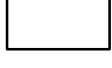
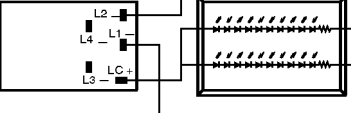
LED Chameleon Models

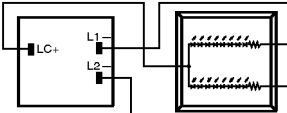
Rated voltage	24 VDC
Model Rectangular M2PJ model 	
Square M2PA model 	





Terminal Arrangement and Coloring Chameleon Models

Wiring	LC+	LC+	LC+
	L1-	L2-	L1- and L2- shorted
Coloring	Green	Red	Orange

■ Panel Cutout

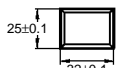
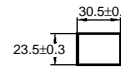
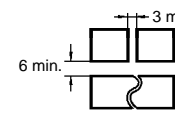
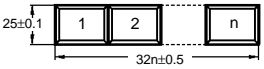
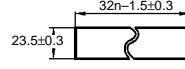

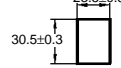

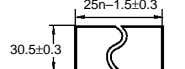
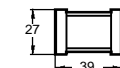
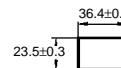
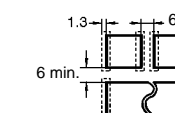
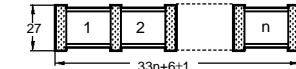
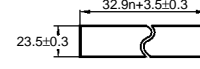
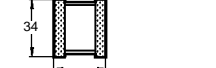
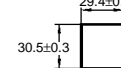
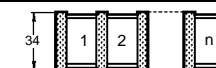
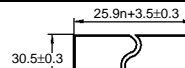
(If using a Switch Guard or Seal Cover, refer to the panel cutout diagrams.)

M2PJ (Rectangular) Models

Classification		Mounting design	Panel cutout	Remarks
Flange mount models	Individual mounting (Horizontal)			Panel cutout spacing between rows of Units: 
	Multiple mounting (Horizontal)			
	Individual mounting (Vertical)			
	Multiple mounting (Vertical)			
Barrier mount models	Individual mounting (Horizontal)			For barrier mount models, refer to Accessories on page 234. Panel cutout spacing between rows of Units: (Dotted line indicates the position of each mounting barrier.) 
	Multiple mounting (Horizontal)			
	Individual mounting (Vertical)			
	Multiple mounting (Vertical)			

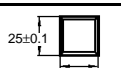
- Note:**
1. n: Number of Units
 2. Recommended panel thickness: 1 to 5 mm
 3. Mount the panel before mounting the Switch Guard.
 4. If the panel is to be finished (e.g., coated), make sure that the panel meets the specified dimensions after the coating.

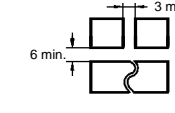
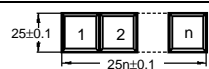
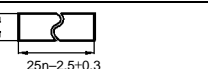
M2PA (Square) Models

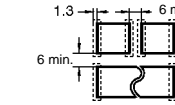
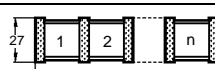
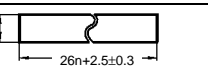
Classification		Mounting design	Panel cutout	Remarks
Flange mount models	Individual mounting			Panel cutout spacing between rows of Units: 
	Multiple mounting			
Barrier mount models	Individual mounting			Panel cutout spacing between rows of Units: (Dotted line indicates the position of each mounting barrier.) 
	Multiple mounting			

- Note:**
1. n: Number of Units
 2. Recommended panel thickness: 1 to 5 mm
 3. If the panel is to be finished (e.g., coated), make sure that the panel meets the specified dimensions after the coating.

M2PT (Round) Models

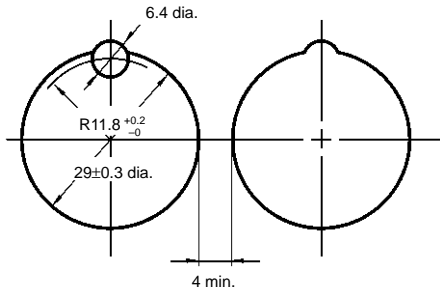

Dimensions

Note: All units are in millimeters unless otherwise indicated.

M2PJ (Rectangular) Models

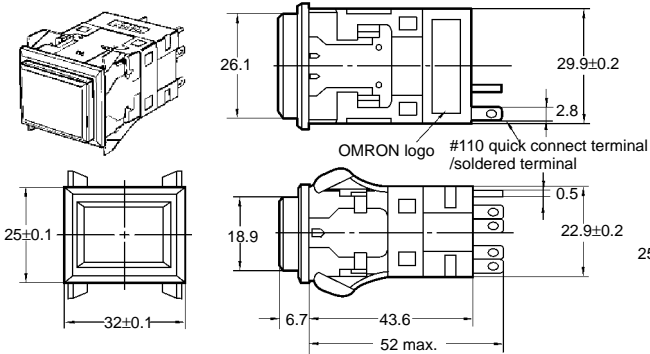

M2PA (Square) Models

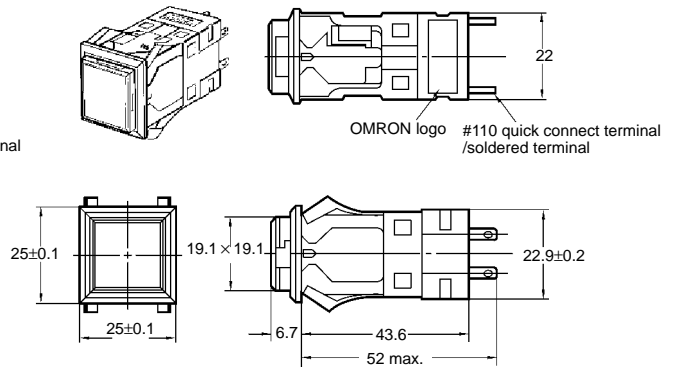

M2PT (Round) Models

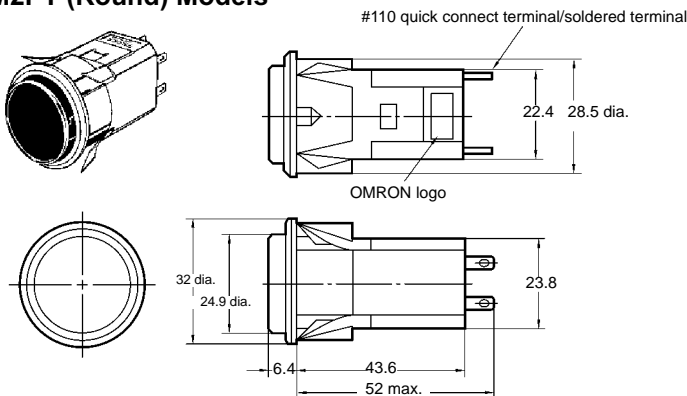

■ Accessory Mounting Dimensions

Dimensions for mounting accessories are the same as those for the A3P Lighted Pushbutton Switches. Refer to page 242.

Precautions

■ Correct Use

Refer to the *Common Precautions* for Pushbutton Switches on page 14.

Refer to *Correct Use* for A3P on page 245.

ALL DIMENSIONS SHOWN ARE IN MILLIMETERS.

To convert millimeters into inches, multiply by 0.03937. To convert grams into ounces, multiply by 0.03527.



OMRON ELECTRONICS LLC

1 Commerce Drive
Schaumburg, IL 60173
847.843.7900
For US technical support or
other inquiries: 800.556.6766

OMRON CANADA, INC.

885 Milner Avenue
Toronto, Ontario M1B 5V8
416.286.6465

OMRON ON-LINE

Global - www.omron.com
USA - www.omron247.com
Canada - www.omron.ca
Brazil - www.omron.com.br
Latin America - www.espanol.omron.com

UNITED STATES

To locate a Regional Sales Office, local Distributor or
to obtain product information, call: 847.843.7900

MEXICO SALES OFFICES

Mexico, D.F.	555.660.3144
Ciudad Juárez	656.623.7083
Monterrey, N.L.	818.377.4281
Querétaro	442.135.4510

BRAZIL SALES OFFICE

Sao Paulo	55.11.2101.6310
-----------	-----------------

ARGENTINA SALES OFFICE

Cono Sur	54.114.787.1129
----------	-----------------

OTHER LATIN AMERICAN SALES

mela@omron.com